



Main catalog

System pro *M* compact[®] Surge and lightning protection solutions with QuickSafe[®] technology



System pro *M* compact[®]

Surge and lightning protection solutions with QuickSafe[®] technology

Presentation	3	1
OVR surge protective devices - IEC version	31	2
OVR surge protective devices - UL version	103	3
Index	134	4

Surge and lightning protection solutions

ABB expertise	6
Causes of transient overvoltages	7
Origins of surges - Electrical operations on the distribution grid	10
General information on lightning	11
Protecting installations	12
Products Standards, IEC 61643	13
QuickSafe® technology	14
Selection of surge protective devices	15
Surge protective device disconnectors	18
Installation and wiring of SPDs in an electrical switchboard	19
Example of an electrical switchboard protected by ABB surge protection solutions	22
Mode of surge protection	23
Coordination and wiring principals	24
General wiring diagrams	25
Selection tool	
TNC network 230 / 400 V	26
TNC-S network 230 / 400 V	27
TT network 230 / 400 V	28
IT network 230 V without neutral	29
TNC, TNS - TT networks 230 / 400 V	30

Panorama

1



OVR Type 1 and Type 1+2 main entrance lightning protection

- Surge and lightning protection (LPZ 0 to LPZ 1 and 2)
- Protection of the installation against direct lightning
- Impulse discharge current (Iimp) from 12.5 to 100 kA.

Exposed building to lightning surges shall be protected with Type 1 or Type 1+2 surge protective devices (SPDs). With a high impulse current discharge capacity (Iimp), they are located at the service entrance of the installation to avoid the destruction of the main switch board. Building protected against lightning with an external lightning protection (simple rod, meshed cage or ESE) must have at least a Type 1 SPD in the main distribution board.



OVR Type 2 and OVR Plus surge protective devices

- Surge protection (LPZ 1 to 2...)
- Sub-distribution board installation
- Prolonged life time of sensitive equipment
- Autoprotected surge protective devices with the OVR Plus range.

Most of the equipment sustain repetitive transient surges. Generated by indirect lightning strikes or by industrial environment, these transient overvoltages deteriorate and drastically reduce the life time of sensitive equipment like computers. Located in the sub-distribution boards of the installation, as close as possible to the equipment to protect, they offer a reliable and safe surge protection.



OVR PV and OVR WT specific surge protection solutions

- Dedicated SPDs for solar and wind application
- Surge and lightning protection from LPZ 0 to LPZ 2
- Cost saving in avoiding down time of installations.

Due to their high exposure to lightning and their specific electrical configuration, solar and wind turbine installations require a dedicated surge and lightning protection which take into consideration their specificities, high DC voltages for solar and high repetitive peak voltages for wind turbines. The use of standard surge protection on such installation may lead to down time or even destruction of the installation.

A bit of history...

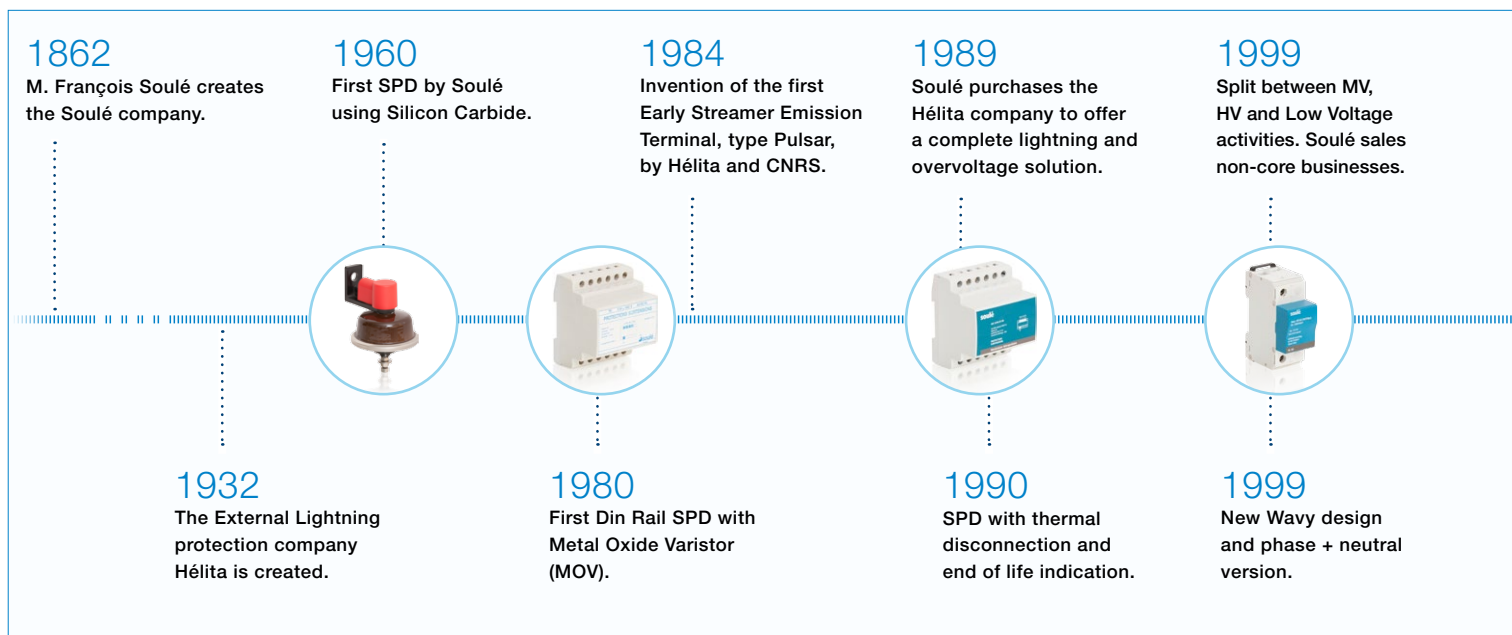



OVR TC dataline protection

- Complete range from 6 to 200 V DC
- RJ 45 bases.



OPR external air terminal lightning protection

- Early streamer emission air terminal
- Complete autonomy
- High efficiency (radius of protection Rp)
- Certified according to NF C 17-102 September 2011.

In order to prevent data losses in Data Centers or to protect flow-meters in water treatment plans, a special range of surge protectors for Data Application has been developed.

Lightning is one of the most spectacular meteorological phenomena. Generated by the interaction of clouds elements (water and ice), it can kill, injure and damage.

Building and equipment installed in exposed areas should be protected by an external air terminal.

2000

Soulé is purchased by Entrelec®.

2004

First Type 1 Spark gap technology. ABB branded.

2010

Launch of the System Pro M Compact® range with Safety Reserve System as option. Unique product in the market back then.

2015

QuickSafe® launch

2001

Entrelec® is purchased by ABB. Soulé & Hérita become the Low Voltage lightning protection experts within the ABB group.

2009

Self Protected SPD, with MCB or fuse.

2014

Launch of the OVR for Street Lightning protection.



Surge and lightning protection solutions

ABB expertise

1

With its experience gained over the last few decades, ABB is using its technological expertise for lightning and over-voltage protection.

The ABB laboratory with several generators can simulate the impact of a direct lightning strike (10/350 μ s impulse wave) or an indirect lightning strike (8/20 μ s impulse wave) to be able to test the surge protective devices.

Through its wide product range, ABB is able to offer a complete solution to protect power and low current networks.

Seminars are organized to the needs of all professionals: design offices, consultants, distributors, electricians, sales staff. These training sessions combine practical and theoretical aspects and cover a varied range of topics such as direct impact protection and overvoltage protection.

The ABB laboratory is able to handle tests on AC surge protective devices (SPDs) according to IEC 61643-11 (2011) and on PV SPDs according to EN 50539-11 (2013).

High power lightning generators	Standardized electrical waves 8/20 μ s and 10/350 μ s. Maximum shock current 100 kA for the two waves, superposed on the electrical network. Stored energy 800 kJ.
200 kV generator	1.2/50 impulse wave Maximum voltage 200 kV Stored energy 10 kJ.
Combination wave generator	Standardized 8/20 - 1.2/50 impulse wave 30 kV maximum 15 kA maximum Stored energy 5 kJ.
Electrical tests	275 V, 18 000 A and 440 V, 10 000 A short-circuit AC testing. 1500 V, 1000 A short-circuit DC testing.
Climatic tests	Ageing and damp heat tests.
High Speed Camera	Up to 120 000 frames/s



ABB laboratory at Bagnères-de-Bigorre, France

2CTC438003S0201

Surge and lightning protection solutions

Causes of transient overvoltages

Transient surges represent the main cause of electrical devices failure and loss of productivity. They are the result of lightning strikes, switching operations on the electrical network or parasitic interferences.

Nowadays, in all the sectors (residential, commercial and industrial), in the data center industry, they rely on their computer systems.

A downtime in one of these computer systems, due to transient surges, can have catastrophic consequences. Loss of operation, loss of service, loss of data and of productivity involve, in most of the cases, huge consequences which are, by far, higher than the costs of the equipments for protection against overvoltages.



The use in electronic systems of more and more sensitive electronic equipments, with interconnection and complexity of the nets increase the probability of damages caused by the transient overvoltages.



Surge and lightning protection solutions

Causes of transient overvoltages

1

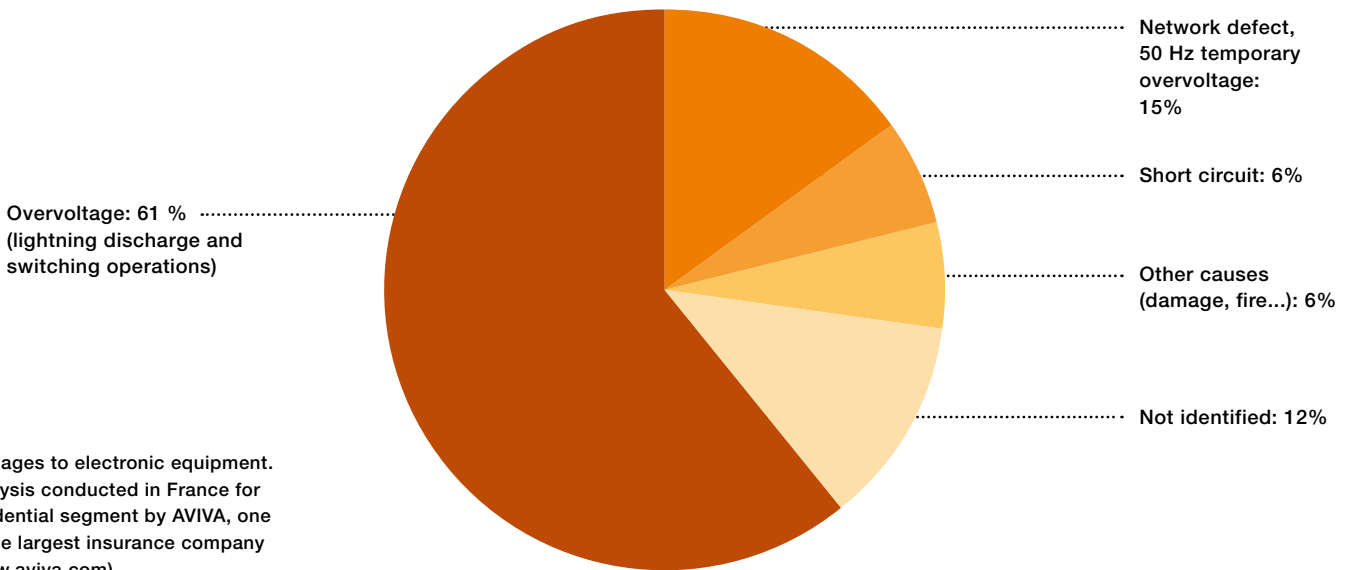

Damages to electronic equipment. Analysis conducted in France for residential segment by AVIVA, one of the largest insurance company (www.aviva.com)

At the same time, the following trends shall be underlined:

- Increasing use of electronic systems such as computers, telecommunication equipment. Overvoltage consequences are of huge importance in a global economy based and relying on power networks and information systems
- Electronic equipment more and more sensitive. With miniaturization process of circuits and components in electronic, modern equipment is now more incline to be damaged from transient overvoltages
- Interconnection and complexity of system networks. In big cities, the effects induced by lightning current are very high due to the fact that they can be propagated by the service lines over many kilometers. Furthermore, the use of lots of industrial equipment generates disturbances, transient overvoltages, on the lines that damage expensive equipment.

Therefore, the protection against lightning current and transient overvoltages is now a fundamental aspect of our electrical system configuration.



Transient overvoltage effect

Surge and lightning protection solutions

Causes of transient overvoltages

Transient overvoltages due to direct lightning effects

When a lightning strikes directly a building equipped with a lightning protection system (LPS), the lightning current is dissipated to the ground through the down conductors. However, the transient overvoltage can be propagated into the building through the earthing of the electrical installation. This type of

direct effect can cause fire, damage the internal installation and the equipment or even worse can injury living beings.

The same with a lightning strike on external line connected to the building, which can, through the cables, create fire and destruction of the internal electrical installation.

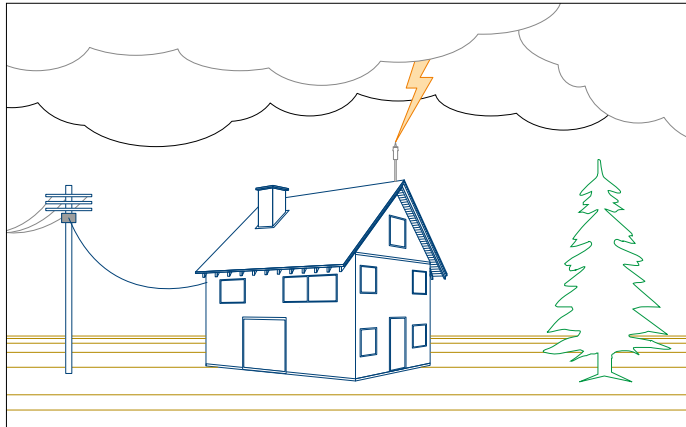

Lightning strike on an external air terminal or on the building

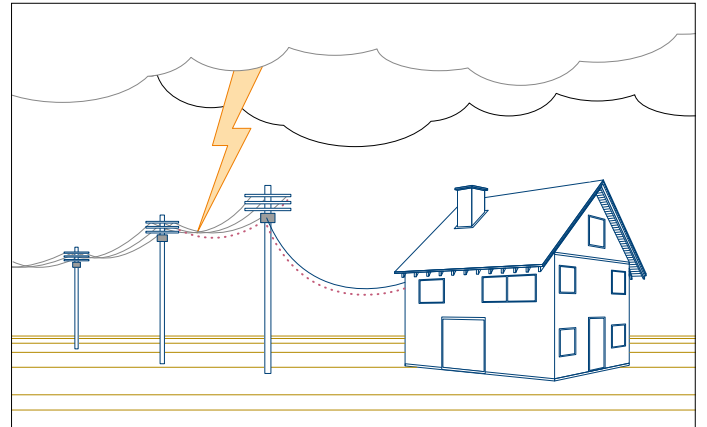

Lightning strike on an overhead line connected to the building

Transient overvoltages due to indirect lightning effects

Transient overvoltages can also be the effect of an indirect lightning strike close to the building or close to external lines connected to the building. In that case, the electromagnetic

field created by the lightning current will generate resistive and inductive couplings. As a consequence, these can cause serious malfunction or damages to the internal installation or equipment.

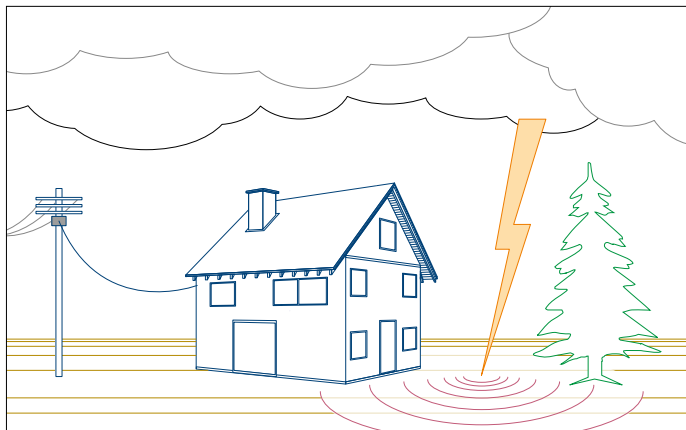

Lightning strike near a building

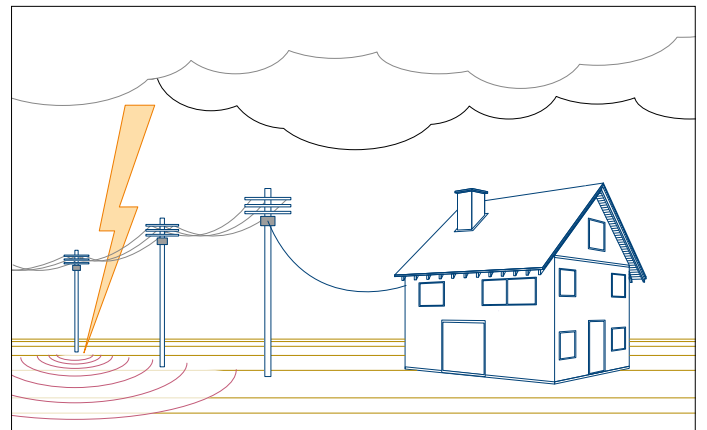

Lightning strike near an overhead line

Transient overvoltages due to switching operations

Switching overvoltages are less powerful and destructive than transient surges caused by lightning. However, they occur much more frequently, causing premature ageing of the equipment.

These overvoltages can in fact result in severe damage to electronic circuit and need to be effectively countered to avoid expensive downtime and maintenance costs.

Surge and lightning protection solutions

Origins of surges - Electrical operations on the distribution grid

1

The switching of breakers, transformers, motors and inductive loads in general or the sudden modification of loads causes sudden current variations (di/dt), generating transient voltage surges. They are less energetic than surges caused by lightning, but they are much more frequent and are damaging as they

are generated directly in the power supply network. Their brief duration, the sharp rising edge and the peak value (which can reach several kV) leads to premature wear of electronic equipment.

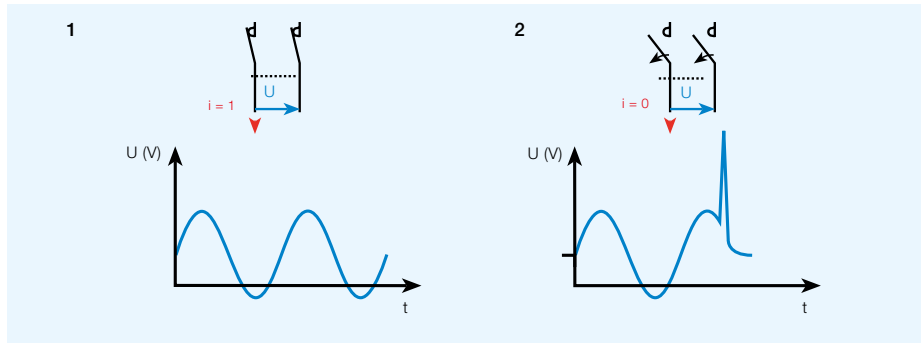

Switching of breakers
1- closed circuit
2- opening of circuit

Order of magnitude of the disturbances.

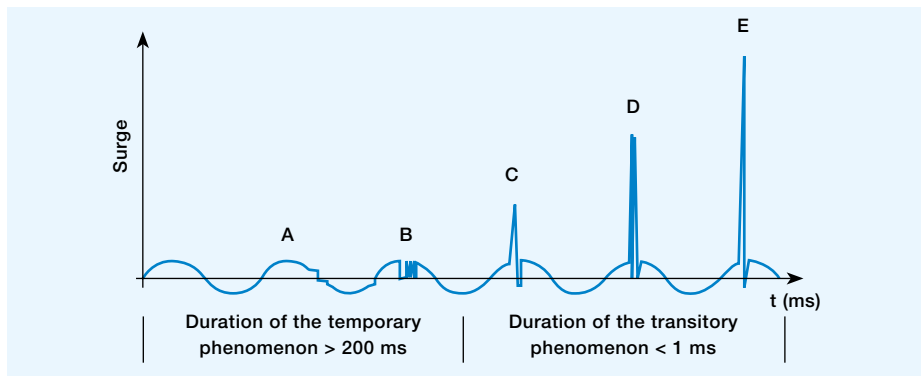

Representation of the different disturbances on the electricity supply grid in AC

- A - Harmonics
- B - Micro-interruptions
- C - Surges from switching
- D - Indirect lightning strikes
- E - Direct lightning strikes

From the point of view of overvoltage surges, direct lightning strikes carry the highest risk.

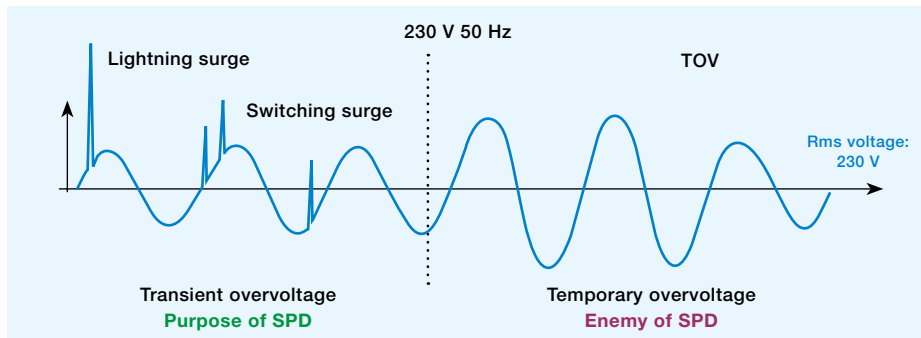

Where to find more
OVR Practical guide for the protection against surges, 1TXH000309C0201.

Surge and lightning protection solutions

General information on lightning

The stress caused by a lightning strike on the network almost always represents the most important parameter when selecting a SPD (Surge Protective Device).

Intensity of direct lightning strikes

The French institute Meteorage conducted a series of measurements of the intensity of over 5.4 million lightning strikes in France over the ten years from 1995 to 2004.

The following curve summarizes the cumulative frequency of the lightning strikes with respect to their intensity, according to the results of this enormous measuring campaign:

- 1.27% of the lightning strikes are greater than 100 kA
- 0.33% of the lightning strikes are greater than 150 kA
- 0.1% of the lightning strikes are greater than 200 kA
- 0.03% of the lightning strikes are greater than 250 kA.

These are values measured in France, however the intensity of lightning has no correlation with the geographical position, and equivalent results would be obtained by performing the same analysis in other countries. What does, however, characterize each geographical area is the density value by geographical area N_g (described on the following page).

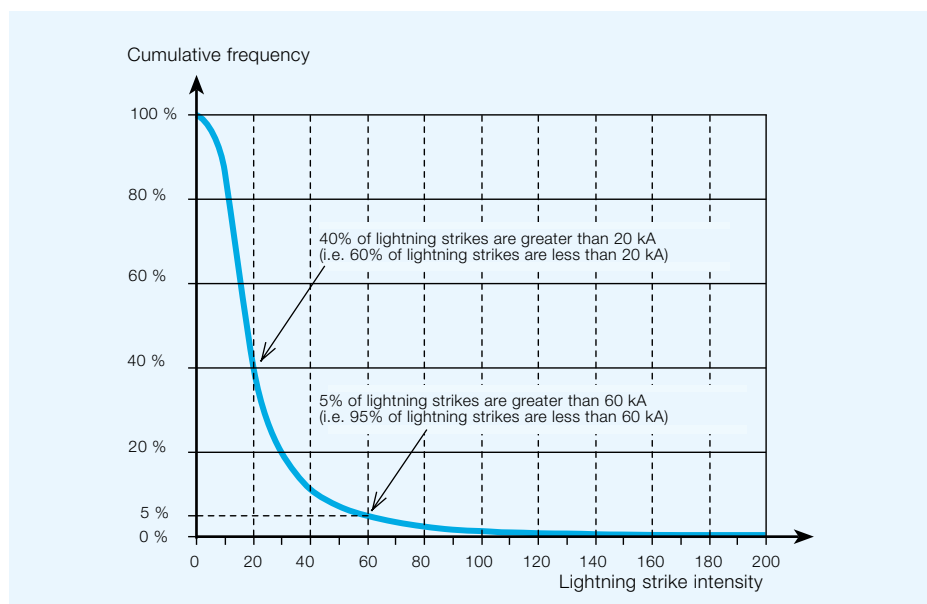

Cumulative frequency of lightning strikes - positive and negative - with respect to their intensity.

Data supplied by Meteorage (www.meteorage.fr)

Where to find more
OVR Practical guide for the protection against surges, 1TXH000309C0201.

2CTC438006S0201

Surge and lightning protection solutions

Protecting installations

End-of-life safety... And when it occurs

1

On average, a 40 kA Type 2 SPD has a lifespan of twenty years, but some may last thirty, and others only five! The data refer to the frequency of lightning strikes according to IEC 62305 standards, to SPD lifespan tests according to IEC 61643-11 and to basic statistics.

A statistical question

- The lifespan of a SPD depends on its resilience connected to its rated discharge current I_n , but also to the number of times lightning strikes near the system each year
- On average, a 40 kA SPD worldwide will reach the end of its life after twenty years
- Given the large number of SPDs installed, statistics tell us that a SPD reaching the end of its life is far from an improbable occurrence; some SPDs (premature) could reach the end of their lives in the first few years of the system's operation...

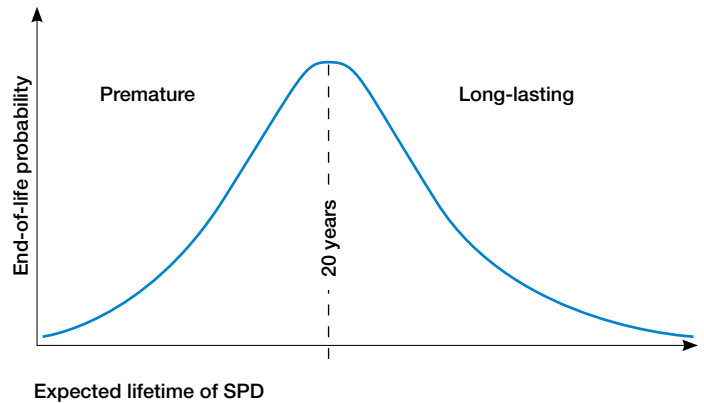

What happens to each of the SPDs I've installed over the years?

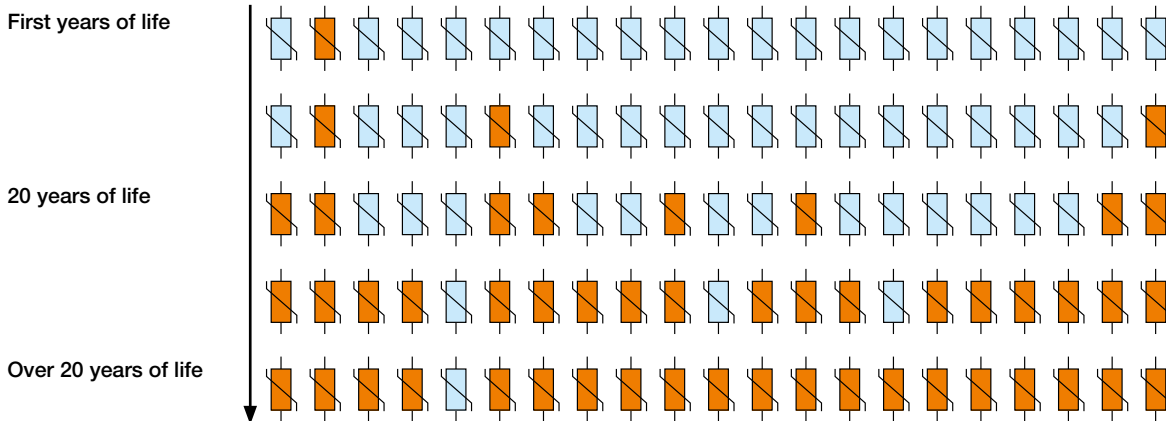

The replacement cartridges allow surge protection to be renewed when one of the SPDs reaches the end of its life-cycle.

Surge and lightning protection solutions

Products Standards, IEC 61643

The new IEC 61643-11:2011 is similar to the EN 61643-11:2012 and is the standard for Low-Voltage Surge Protective Devices. These standards exist since the nineties and have gone through different releases improving them. In the last release not only the evaluation of the product performances is under focus, but the stress on safety evaluation.

Regarding performances, this new edition recognizes the possibility to evaluate and certify a SPD under multiple categories, option not considered in the previous editions. So in order to certify an SPD under the Type 1 and Type 2 category, two different tests need to be performed to validate the features under each one of them.

Until now, the safety of the SPD was verified reproducing situations that represent the working conditions of the SPD, as for example, the short-circuit test or the temporary over-voltage test. According to the new edition of the standard, new tests reproducing the potential interruption of the Neutral conductor and the different modes of end of life of the SPD are performed.

These two additional tests are a real Plus on safety management and they are a guarantee for the final user that the installation will not suffer any stress in case of the end of life of the SPD. The new QuickSafe® range has been specially developed to answer to these new requirements. All this reducing the stress on the back-up protection device.

The new QuickSafe® technology allows to comply with the end of life tests thanks to a patented internal disconnection system, this systems disconnects the internal circuit before the internal components (MOVs) go into short-circuit.

The advantage for the customer is that the product is self-protected up to higher values of current and this allows to install back-up protection elements with higher rated current, as these elements will only intervene in the rear case of a short-circuit on site together with a sudden End of Life of the SPD (this happens when for example the SPD is hit by a current higher than its I_{max}).

You will find the tables on page 18 indicating the maximum back-up rated current MCB or fuse to use to guarantee the coordination.

This new technology allows as well to increase the prospective withstand short-circuit current at the point of the installation up to $I_{scrr} = 100$ kA with a back up protection of maximum rated current of 125 A (for OVR T2 QS and OVR T2-T3 QS) and 160 A (for OVR T1-T2s QS and OVR T2s QS).

In simple words, the new OVR QuickSafe® can be used in 99.9% of standard installations and becomes an easy replacement to any other SPD ranges.

What's new in IEC/EN 61643-11:2012?

- New test procedure which takes into account the failure behavior of protective equipment in the event of an overload, or when the service life has expired
- The Type 1 operating duty test is conducted with a higher current than that specified in the previous standard
- Recognition of the mixed types, as Type 1+2 and Type 2+3, this allows as to certify the product with more than one category.

Thermal Disconnection – Temperatures measured at the disconnection point of the MOV

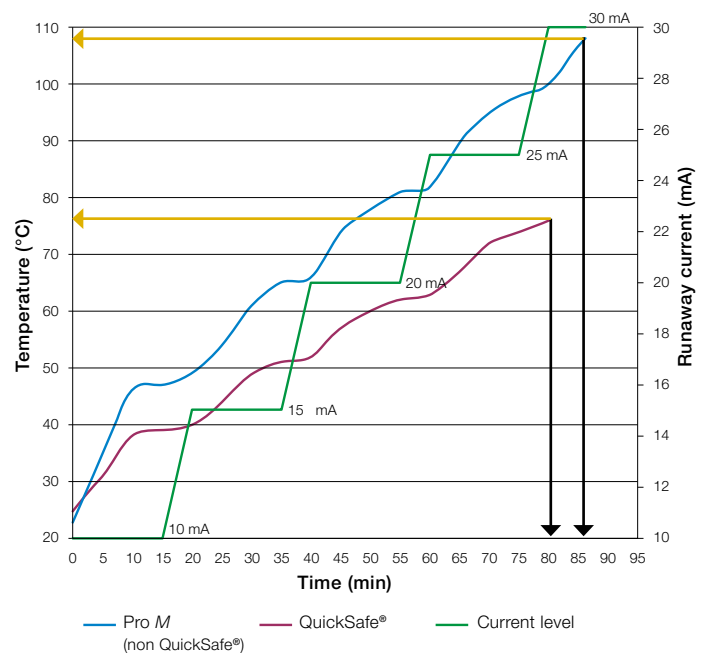

Here we can see 2 different curves representing the behavior of the actual range (blue curve) and the new QuickSafe® range (red curve), for the same level of current (the green line represent the evolution of the current with the time, as specified by the IEC 61643-11).

- These curves represent the temperature INCREASE that the MOV suffers when being tested under these values of current for the indicated time. These are NOT absolute temperature, but relatives ones
- As you can see with the black arrows, the time to guarantee the disconnection for the same level of current has been reduced by 6 minutes
- And even better, as you can see with the orange arrows, the maximum reached temperature required to guarantee the disconnection is lower, from 108 to 76 °C.

Surge and lightning protection solutions

QuickSafe® technology



1

In case of an end of life of an MOV in normal conditions, the current passing through the MOV increases progressively creating a quick temperature increase. This phenomenon will slowly damage the MOV itself until it gets into short-circuit. This phenomenon is called a thermal runaway.

In order to avoid such thermal runaway we have added a thermal disconnection that will detect this temperature increase and will open the circuit.

This disconnection QuickSafe® is directly welded into the surface of the MOV to allow a very fast detection of the raise of

temperature, it will react opening the circuit when the temperature achieve the levels considered hazardous for the installation. This disconnection is guaranteed by a metallic arm linked to a spring guaranteeing a quick disconnection.

This is a phenomenon that happens only after thousands of surge protection interventions in average. Most of SPDs get changed during the installation updates before this ever happens. This is the ultimate protection at the very end of life of the SPD.



1

Here the disconnection system in Close position. During the test simulating and end of life of the SPD, the SPD has to bear a high voltage that forces a current passing through it. In this example, the passing current is 10 A.

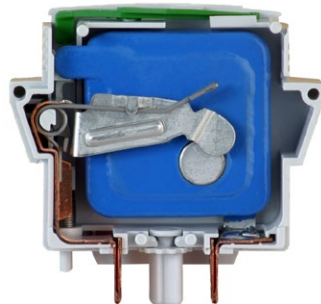

2

Few seconds later, the MOV achieves a temperature that is high enough to melt the special metallic alloy that guarantees the contact and the mechanical position of the metallic arm. This releases the metallic arm pushed far away by the junction spring.



3

The tension in the spring is enough to quickly push up the arm and guarantee the insulation of the MOV. The speed of this movement is a key feature to interrupt the electric arc that will appear between the MOV core and the metallic arm. This movement combined with the characteristics of the MOV will guarantee the complete extinction of the arc.



4

At the end of this movement, the metallic arm will stop without any bouncing. There is no risk of a new electric arc development. At this moment, the MOV has not suffered any thermal runaway, so it is not in short-circuit. The distance between between the MOV electrode and the metallic arm guarantees an insulation voltage of over 6000 V, avoiding any risks for the installation.

Surge and lightning protection solutions

Selection of surge protective devices

The IEC standard introduced the concept of lightning protection zones (LPZ) to help in selecting the correct surge protection. This concept ensure the gradual reduction by stages of the energies and overvoltage caused by lightning or switching operations. This logic of coordination in the protection is what we call the "stepping protection".

External Zones:

- LPZ 0A Unprotected zone outside the building subject to direct lightning strikes and therefore may have to handle to the full lightning current and lightning electromagnetic field
- LPZ 0B Zone protected against direct lightning strikes by external air terminal and where the threat is the full lightning electromagnetic field.

Internal Zones:

Zones inside the building which are protected against direct lightning flashes.

- LPZ 1 Zone subject to partial lightning or surge currents. Type I SPDs shall be installed at the boundary between LPZ 0A and LPZ 1 to reduce the entrance of lightning currents through power lines
- LPZ 2...n Zone where the surge current is limited by current sharing and where the surge energy is reduced by additional surge protection like SPDs. Type 2 SPDs are installed at the boundaries of each zone, i.e. LPZ 1 and LPZ 2, LPZ 2 and LPZ 3, etc.

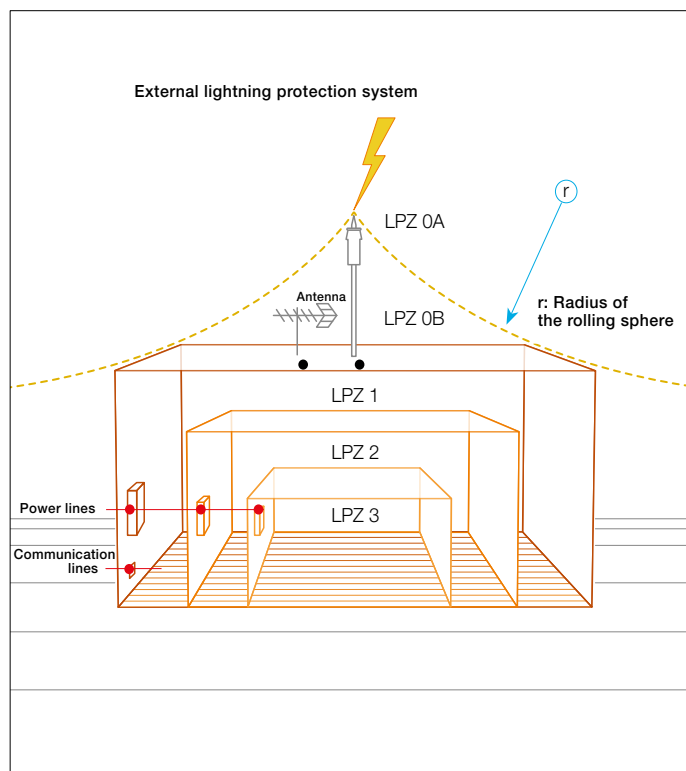

Lightning protection zones description (IEC 62305-4):

It consists in dividing a building in several volumes: the protection zone. The objective is to ensure that the LPZ gives enough protection to the equipment inside this zone. To do so, SPDs are installed at the protection zone boundaries. Each time an SPD is installed, a new protection zone is created.

Current impulse:

The 10/350 and 8/20 impulse waves are used in the Class I and Class II SPDs tests. The first number gives the rising time of the current impulse to reach 90% of the peak level and the second number gives the time to half value in micro-seconds (μs).

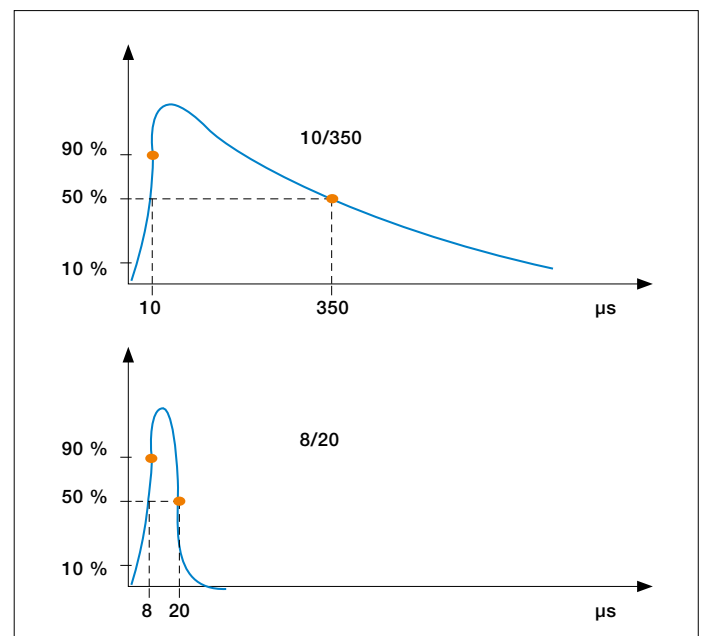

Surge and lightning protection solutions

Selection of surge protective devices

1 Protection level and impulse withstand voltage

The protection level (U_p) of the SPD shall be selected according to the level of overvoltage given to the equipment to be protected against transient surge.

Each equipment is rated with an impulse withstand voltage (U_w) depending on its category. An equipment is protected if its U_w is greater than the expected transient overvoltage between the live conductors and earth (common mode). If not, an SPD must be installed.

The SPD is protecting the equipment if its protection level (U_p), which is calculated under the nominal current (I_n), is equal or lower to the impulse withstand voltage of the equipment:

$$U_{p/f} \leq U_w$$

The IEC 60364-4-44 defines the required impulse withstand voltage as described in the table below:

Categories*	U_n		Examples
	230 / 400 V	400 / 690 V	
I	1500 V	2500 V	Equipment containing particularly sensitive electronic circuits: – computer workstations, computers, TV, HiFi, Video, Alarms, etc. – household appliances with electronic programmers, etc.
II	2500 V	4000 V	Domestic electrical equipment with mechanical programmers, portable tools, etc.
III	4000 V	6000 V	Equipment subject to special requirements. Distribution panels, switches, breakers, etc.
IV	6000 V	8000 V	Equipment for use at the origin of the installation. Electricity meters, circuit-breakers, etc.

* IEC 60664-1

Selection of surge protective device

The selection of the surge capacity of SPDs depends on the surge and lightning risk, determined by the risk analysis according to IEC 62305-2. If there is a direct lightning risk on the structure, a Type 1 SPD will have to be installed at the service entrance and Type 2 and Type 3 SPDs in the sub-distribution boards, as close as possible to the equipment to protect.

If there is not a direct lightning risk on the structure (no external protection, no aerial lines connected) a Type 2 SPD can be installed at the service entrance and in the sub-distribution boards.

A Type 1 SPD will be selected by its maximum impulse current (I_{imp}) characteristics, and a Type 2 SPD by its nominal current (I_n) and maximum discharge current (I_{max}) characteristics.

Basic example for a Type 1 SPD calculation (IEC 62305-4):

- Lightning Protection Level calculated: LPL I
- Maximum peak current: $I=200$ kA
- Assumption: perfect current sharing
- Number of connected service supply (earthing, water pipe): $m=2$
- Network configuration: 3 Phases + Neutral ($n=4$).

$$\begin{aligned} \text{Total current } (I_{imp})/\text{phase} &= I \times 0.5 / (m \times n) \\ &= 200 \times 0.5 / (2 \times 4) \\ &= 12.5 \text{ kA} \end{aligned}$$

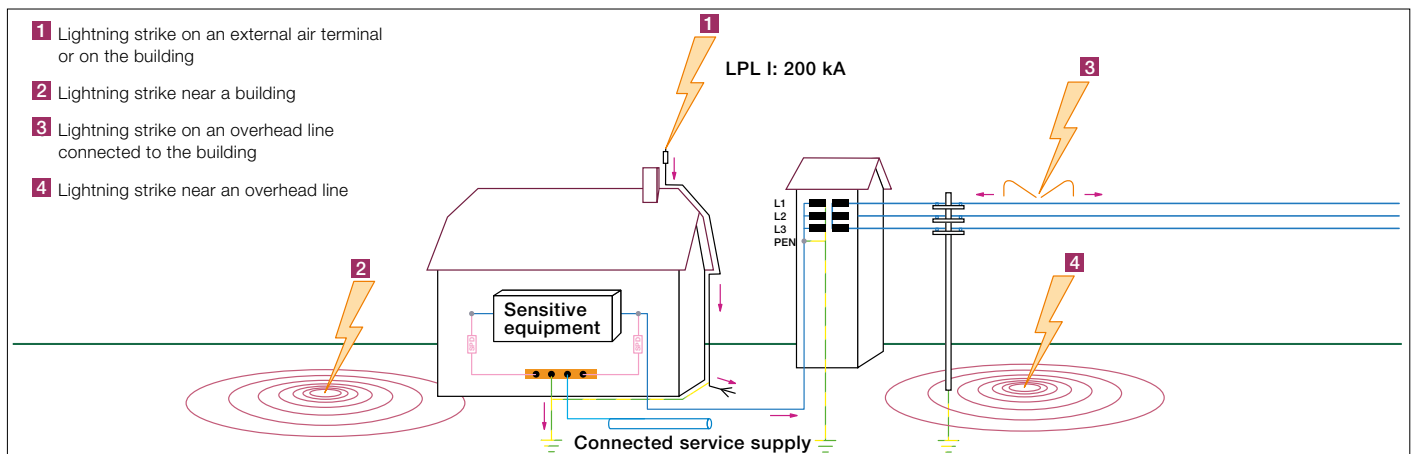

2CTC438008S0201

Surge and lightning protection solutions

Selection of surge protective devices

End of life indicator of the standard surge protective device

This option enables indication of the surge protective device state via a mechanical indicator which changes from green to red as the surge protective device comes to end-of-life. When this occurs, the surge protective device must be changed as protection is no longer guaranteed.

End of life of the surge protective device fitting Safety Reserve (s) system

In case of current surge exceeding the maximum capacity of the device, one of the MOVs could achieve the end of life, the surge protective device will switch to the Safety reserve position and the mechanical end of life indicator in the front of the product will switch to the intermediate position. Consequently, the user can see in advance that the protection features of the SPD are degraded, but still guaranteed and has more time to replace the cartridge, because in Safety reserve position the protection is still ensured due to the 2-stage disconnecting system.

If the customer wants to be warned in case one of the MOVs achieves its end of life and the product gets into Safety Reserve, the SPD has to be fitted with a Remote Auxiliary contact (TS). This Auxiliary Contact will change status as soon as one of the MOVs gets damaged.

The combination of the Auxiliary contact (TS) and the Safety Reserve System allow to perform **Preventive Maintenance**, as the information about the degradation of the protection features will be received while the protection is still guaranteed, allowing for the schedule of maintenance activities while the site is still protected.

Technical features of the integrated auxiliary contact

- Contacts information: Normally-opened (NO) / Normally-closed (NC)
- Min. load: 12 V DC - 10 mA
- Max. load: 250 V AC - 1 A
- Connection cross-section: 1.5 mm².

End-of-life indicator standard SPD



End-of-life indicator with safety Reserve system



NOTE:

A faulty surge protective device does not interrupt continuity of service (if wired such that priority is given to continuity of service), it simply disconnects itself. But, the equipment is no longer protected.



NOTE:

Pluggable surge protective device cartridges have a foolproof system (Neutral cartridges different to Phase cartridges) preventing incorrect operations when replacing a cartridge.

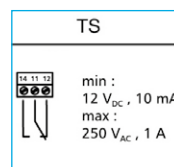

Wiring schematic

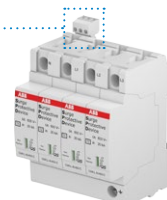

Surge protective device fitted with the auxiliary contact option

Pluggable

The pluggable feature of ABB surge protective devices facilitates maintenance. Should one or more worn cartridges need to be replaced, the electrical circuit does not have to be isolated nor do the wires have to be removed.

Auxiliary contact (TS)

This function, achieved by wiring a 3-point 1 A volt-free contact, enables the operational state of the surge protective device to be checked remotely (maintenance premises). For standard products, the TS changes status when the cartridge needs to be replaced, protection is not guaranteed. On products fitting the Safety Reserve system, it indicates that one component of the cartridge is damaged, but the protection is still guaranteed.

pro M compact® range

Max. discharge current I_{max} 8/20

- 10 kA
- 20 kA
- 40 kA
- 80 kA
- 120 kA

Impulse current I_{imp} 10/350

- 12.5 kA
- 25 kA

s: with safety reserve

P: pluggable device

QS: QuickSafe® Technology

OVR T2 N1 40 275 s P TS QS BW

Designation:

- T1: Type 1 SPD
- T1-T2: Type 1+2 SPD
- T2: Type 2 SPD
- T2-T3: Type 2+3 SPD
- PLUS: Autoprotected SPD
- PV: Photovoltaic SPD
- TC: Dataline SPD
- WT: Wind turbine SPD

Phases:

- Without: 1 pole
- 2L: 2 poles
- 3L: 3 poles
- 4L: 4 poles
- N: 1 neutral
- 1N: 1 phase (left) - neutral (right)
- 3N: 3 phases (left) - neutral (right)
- N1: neutral (left) - 1 phase (right)
- N3: neutral (left) - 3 phases (right)

Max. operating voltage U_c

- 600 V
- 440 V
- 350 V
- 275 V
- 150 V
- 75 V

Auxiliary contact

BW: Bottom Wiring

Surge and lightning protection solutions

Surge protective device disconnectors

1 Choice of backup protection

Surge protective device must have disconnectors which are internal and external. Internal is the so called thermal disconnection which helps to disconnect the SPD at the end of life (varistors technology). External is the backup protection which can be an MCB or a fuse dedicated to the SPD protection in case of short circuit due to very high surge transient current for example.

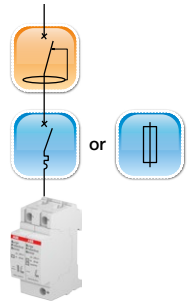

Designation	Function
Protection against indirect contact	Residual current devices (RCDs) assure a protection to people and installation. When installed with SPDs they must be of selective type "S" to avoid nuisance tripping. In ABB portfolio you can choose the F200 S type range for a safer installation.
Protection against fault currents	Miniature circuit breakers (MCBs) or fuses protect the installation against overload and short circuit. They can be associated with SPDs for the backup protection in agreement with coordination installation rules. You can either choose MCBs from the S200 or S800 series or fuses from the E90 range.
Thermal protection	The thermal disconnection is an internal disconnection which is there to bring a safer protection to the equipment. ABB is always developing new patents and has developed a thermal disconnection mechanism specifically dedicated to PV installation with the OVR PV range for a better and safer protection.

Type of Surge Protective Devices



Circuit breaker maximum ratings* curve B or C Prospective short circuit current at SPD location (Ip)



Fuses maximum ratings* (gL - gG)

Ip ≤ 6 kA Ip ≤ 10 kA Ip ≤ 25 kA Ip ≤ 50 kA

Type	Ip ≤ 6 kA	Ip ≤ 10 kA	Ip ≤ 25 kA	Ip ≤ 50 kA	Fuses
Type 1					
OVR T1 unpluggable Iimp 25 kA / Ifti ≤ 7 kA Uc 255 and 440 V	-	-	-	S800 S - 125	125 A fuse
Type 1+2					
OVR T1+2 unpluggable Iimp 25 kA / Ifti ≤ 15 kA Uc 255 V	-	-	-	S800 S - 125	125 A fuse
OVR T1+2 unpluggable Iimp 15 kA / Ifti ≤ 7 kA Uc 255 V	-	-	-	S800 S - 125	125 A fuse
OVR T1-T2 pluggable QuickSafe® Safety Reserve Iimp 12.5 kA / Ifti ≤ 7 kA Uc 275 V, 440 V	-	-	-	S800 S - 125	160 A fuse
Type 2					
OVR T2 pluggable Imax 15 kA Uc 75 V	S200 M - 16	S200 M - 16	-	-	16 A fuse
OVR T2 pluggable Imax 120 kA Uc 440 V	S200 M - 50	S200 M - 50	S200 P - 50	S800 S - 50	50 A fuse
OVR T2 pluggable QuickSafe® Imax 40 kA Uc 275, 350, 440, 600 V	S200 - 63	S200 M - 63	S200 P - 63	S800 S - 125	125 A fuse
OVR T2 pluggable Safety Reserve QuickSafe® Imax 40 and 80 kA Uc 275, 440 V	S200 - 63	S200 M - 63	S200 P - 63	S800 S - 125	160 A fuse
OVR T2 unpluggable Imax 20 and 40 kA Uc 150 V, 275 and 440 V	S200 M - 50	S200 M - 50	S200 P - 50	S800 S - 50	50 A fuse
Type 2+3					
OVR T2-T3 pluggable QuickSafe® Imax 20 kA Uc 275, 350, 440, 600 V	S200 - 63	S200 M - 63	S 200 P - 63	S 800 S - 125	125 A fuse
Type 3					
OVR T3 unpluggable Imax 10 kA Uc 275 V	S200 M - 10	S200 M - 10	-	-	25 A fuse

* Maximum ratings, must be in accordance with the installation to follow coordination rules with main or upstream short circuit protection(s).

Service entrance SPDs	PE connection cable size
Type 1	16 mm ²
Type 2	4 mm ²

Surge and lightning protection solutions

Installation and wiring of SPDs in an electrical switchboard

Connection distance

50 cm rule

A lightning current of 10 kA generates a voltage drop of approximately 1200 V in 1 m of cable due to the inductance of the conductor. Equipment protected by a SPD is therefore subject to a voltage of U_{prot} equal to the sum of:

- Protection level of the SPD U_p
- Voltage at the terminals of the back-up protection U_d
- Voltage in the connections U_1, U_2, U_3

$$U_{prot} = U_p + U_d + U_1 + U_2 + U_3$$

To maintain the level of protection below the impulse withstand voltage (U_w) of the devices to be protected, the total length ($L = L_1 + L_2 + L_3$) of the connecting cables must be as short as possible (less than 0.50 m).

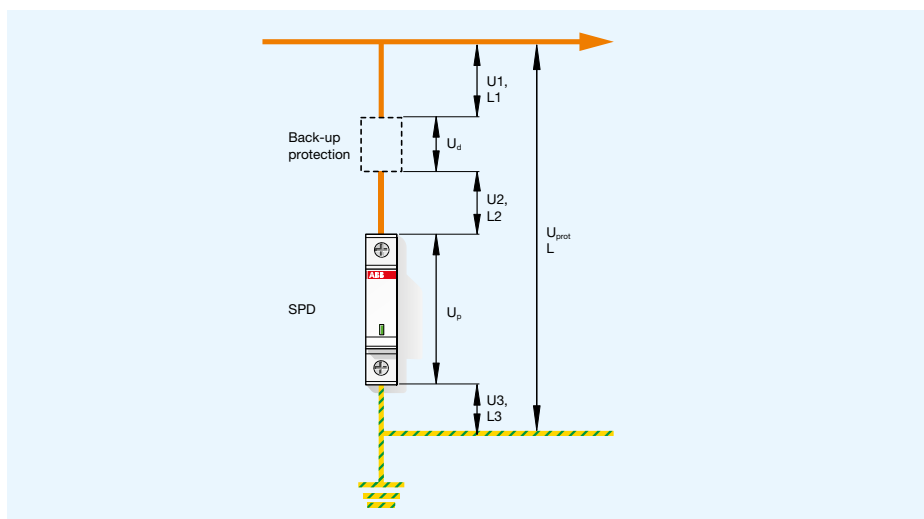

It is necessary to pay attention to the actual length of the connections, which must be measured from the SPD's terminals to the point at which the cable is taken off as a spur from the main conductor. Here is an example which demonstrates the importance of the lengths of connections (for simplicity the diagram omits the back-up protection).

A: in this case...

$$L = L_1 + L_2$$

The length L_3 has no effect on the protection of equipment.

B: in this case...

$$L = L_1 + L_2 + L_3$$

If the length of L_3 is several meters, considering that every extra meter of wire increases the protection voltage by 1200 V, the protection loses a lot of effectiveness.

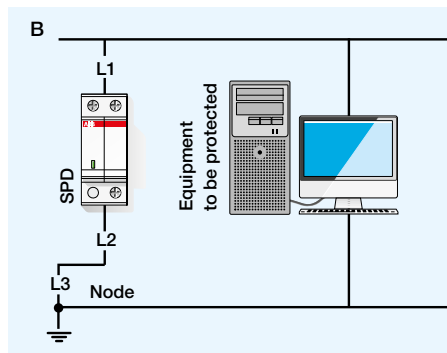
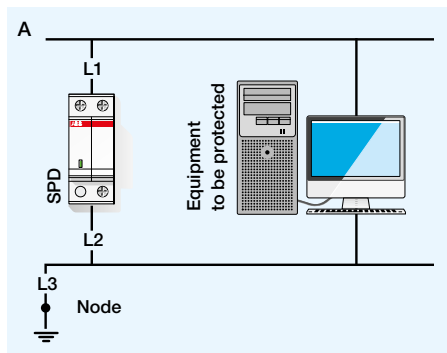

The equipment's earth connection must be distributed, starting from the connection of the SPD which protects it.

Surge and lightning protection solutions

Installation and wiring of SPDs in an electrical switchboard

1

In the case where the length of the connection ($L = L1 + L2 + L3$) exceeds 0.50 m, it is recommended to adopt one of the following steps:

- 1) Reduce the total length L :
 - By moving the installation point of the SPD in the switchboard;
 - Using V, or "entry-exit" wiring, which allows the lengths of the connections to be reduced to zero (it must, however, be ensured that the rated line current is compatible with the maximum current tolerated by the SPD's terminals);
 - In large switchboards, connect the PE coming in to an earth bar near the SPD (the length of the connection is only the spur off from this point, so a few cm); downstream of the connection point, the PE can be taken to the main earth bar.

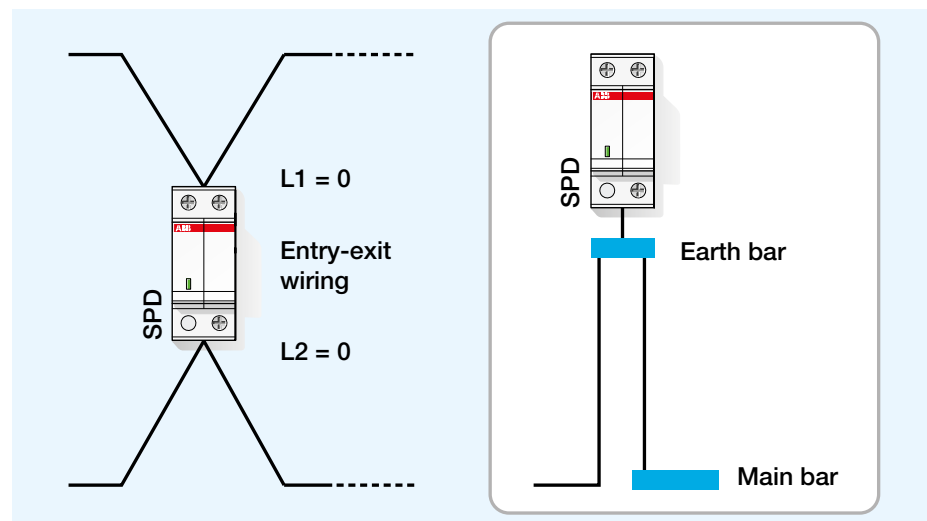

- 2) Choose a SPD with a lower level of protection U_p

Install a second SPD coordinated with the first as close as possible to the device to be protected, so as to make the level of protection compatible with the impulse withstand voltage of the equipment.

Surge and lightning protection solutions

Installation and wiring of SPDs in an electrical switchboard

Electrical lines and connection area

It is necessary to arrange the lines so that the conductors are as close as possible to each other (see figure) to avoid surges induced by inductive coupling of an indirect lightning strike with a large loop contained between the phases, the neutral and the PE conductor.

Cabling of protected and non-protected lines

During installation, run the protected and non-protected wiring according to the instructions in the diagrams below.

To avoid the risk of electromagnetic coupling between different types of wires, it is strongly recommended they be kept at a distance from one another (> 30 cm) and that when it is not possible to avoid them crossing, this needs to be performed at a right angle.

Distance between two wires:

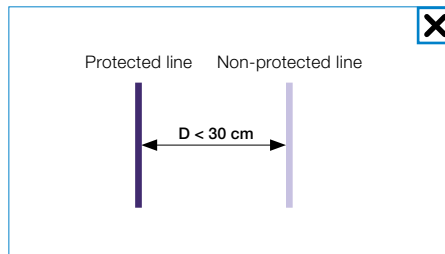
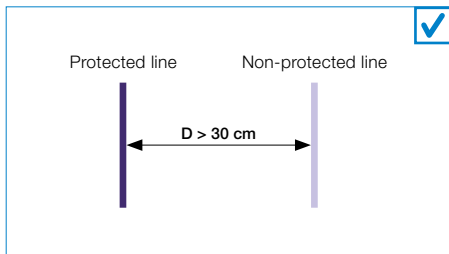

Wires crossing:

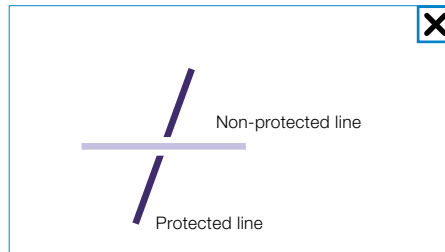
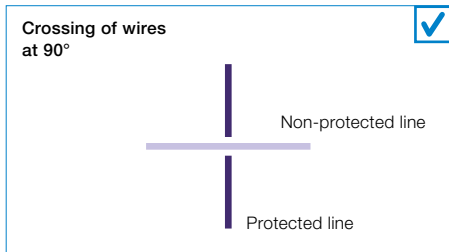

Equipotential earthing

It is fundamental to check the equipotentiality of the earths of all the equipment. The equipment's earth connection must also be distributed, starting from the connection of the SPD which protects it.

This allows the connection distances and therefore the voltage U_{prot} to be limited.

Section of the connections

Wiring between active network conductors and the SPD

The cable section must be at least the same as the upstream wiring. The shape of wiring is more important than the section. The recommended section for Main Board is 10 mm² for phase and Neutral and 16 mm² for earth.

Wiring between the SPD and earth

The minimum section is 4 mm² in the case where there is no lightning conductor, and 10 mm² in the case one is installed. It is nevertheless recommended to use a cable with a greater section to leave a safety margin, e.g. 10-20 mm² section.

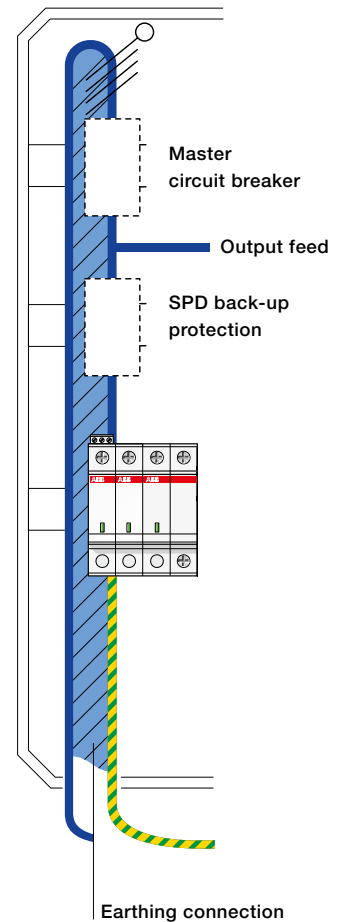

Surge and lightning protection solutions

Example of an electrical switchboard protected by ABB surge protection solutions

1

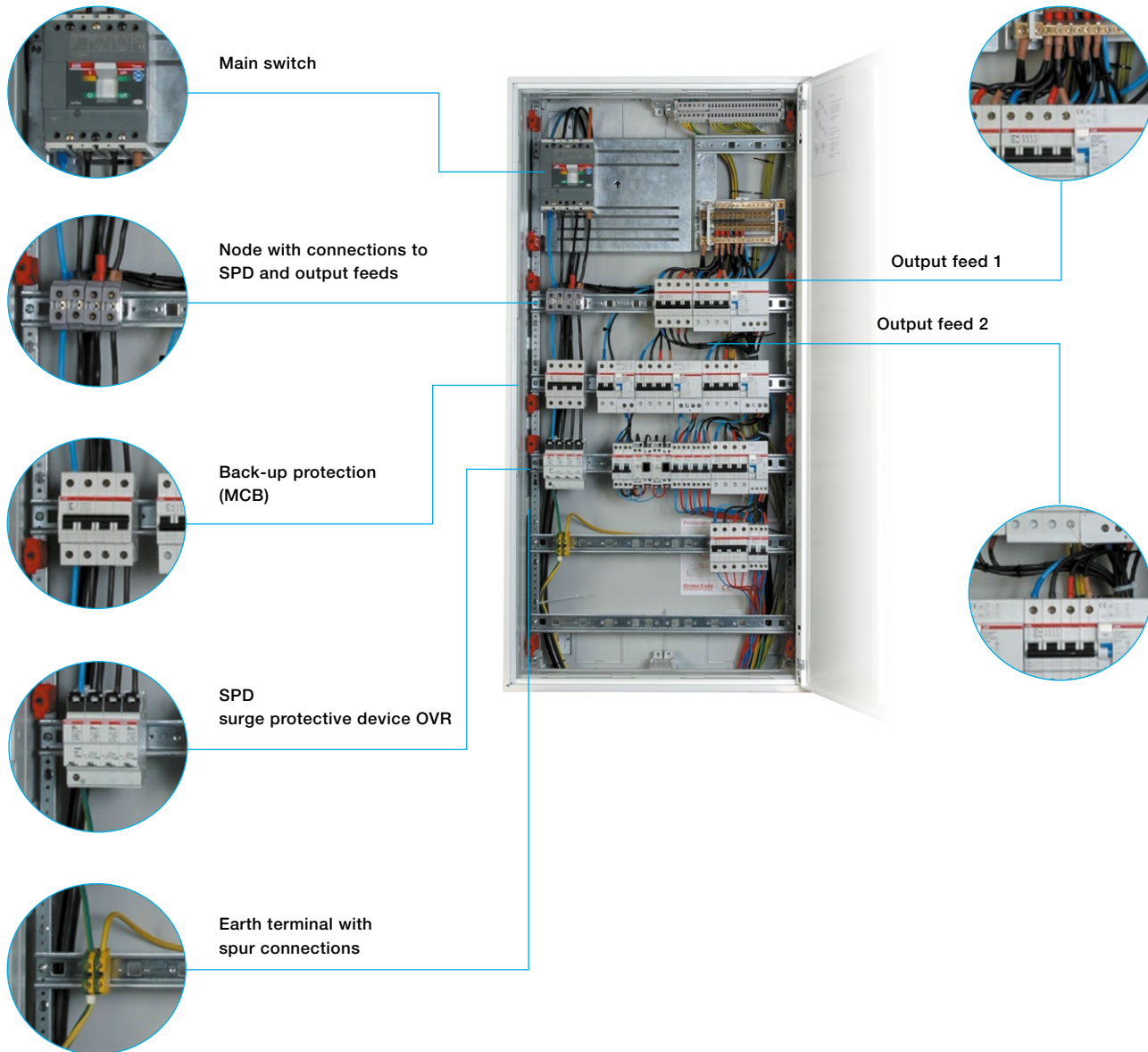

Rules followed by the installer:

- Connection distances < 50 cm
- Earth terminal in proximity to SPD
- Back-up protection dedicated to the SPD
- Protection installed upstream of RCDs
- Reduction of the loop between the phases, neutral and PE

Surge and lightning protection solutions

Mode of surge protection

Protection in common and/or differential mode

Common mode

Overvoltages in common mode concern all neutral point connections. They occur between the live conductors and earth (e.g. phase/earth or neutral/earth). The neutral conductor is a live cable, as well as the phase conductors.

This overvoltage mode destroys not only earthed equipment (Class I), but also non-earthed equipment (Class II) with insufficient electrical insulation (a few kilovolts) located close to an earthed mass. Class II equipment that is not situated close to an earthed mass is theoretically protected from this type of attack.

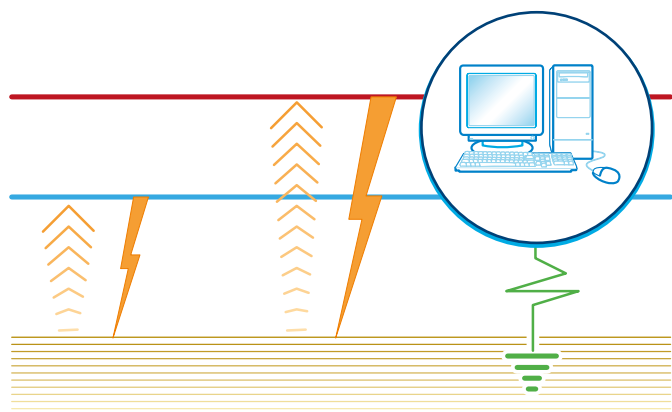

Overvoltages in common mode

Differential mode

Overvoltages in differential mode circulate between the live phase/phase or phase/neutral conductors. They can cause considerable damage to any equipment connected to the electrical network, particularly "sensitive" equipment.

These overvoltages concern TT earthing systems. They also affect TN-S systems if there is a significant difference in length between the neutral cable and the protective cable (PE).

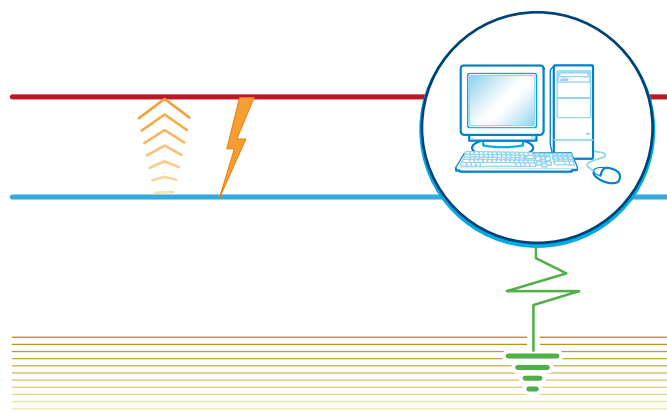

Overvoltages in differential mode

Different types of OVR configuration

Either Common mode or differential mode of protection are required depending on the system configuration (IT, TNC, TNS, TT). For that purpose, you can find different OVR configuration (single pole, 3L, 4L, 1N, 3N).

Common mode configurations (TNC networks)

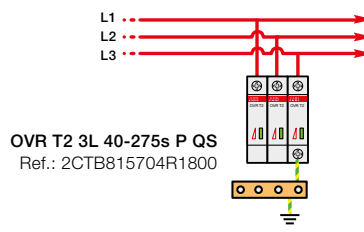
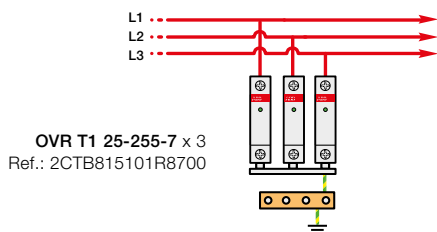

Common and differential mode configurations (TNS, TT networks)

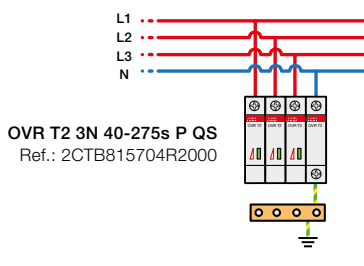
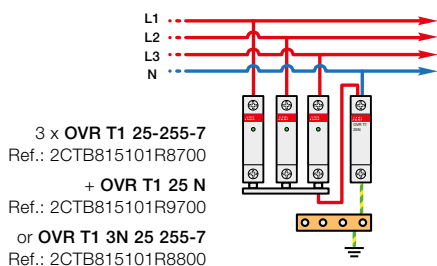

Surge and lightning protection solutions

Coordination and wiring principals

1

The SPD installed at the line entrance of an installation may not ensure an effective protection to the whole system. As a matter of fact, the selection of the voltage protection level (U_p) of SPDs depends on many parameters: Type of equipment to be protected, the length of the connections to the SPDs, the length in between the SPDs and the equipment to be protected.

Coordination required if :

The protection level (U_p) of the SPDs is not low enough to protect the equipment.
If the distance in between the SPDs and the equipment is >10 m.

NOTE:

The first SPD is diverting most of the surge current to the ground, and the second SPD will ensure a good protection level to the equipment.

It is what we call the stepping protection.

SPDs coordination tables and minimum cable length

Type 1
limp = 25 kA
(10/350)

$I_{ni} = 50$ kA

Type 1
limp = 25 kA
(10/350)

$I_{ni} = 7$ kA

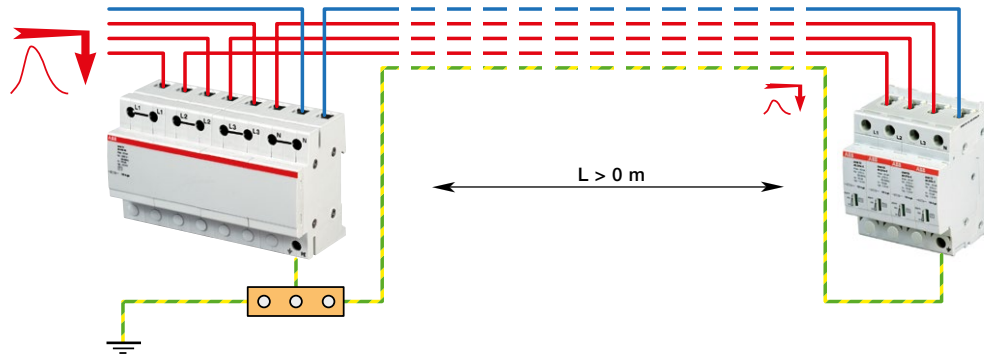

Type 2 s QS
80/40 kA
(8/20)

Type 2 QS
40 kA (8/20)

Type 2+3 QS
20 kA (8/20)

Type 1+2
limp = 15 kA
(10/350)

$I_{ni} = 7$ kA

Type 1+2 T1-T2
Quicksafe®
limp = 12.5 kA
(10/350)

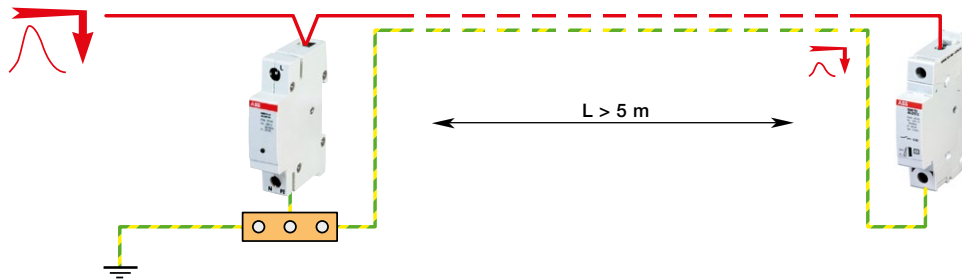

Type 2 QS
40 kA (8/20)

Type 2+3 QS
20 kA (8/20)

Type 2 s QS
80 kA (8/20)

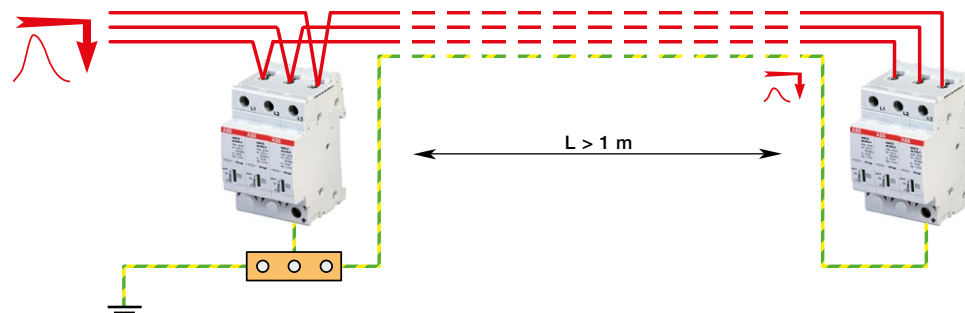

Type 2+3 QS
20 kA (8/20)

Surge and lightning protection solutions

General wiring diagrams

Wiring diagrams according to IEC 60364-1

TNC networks
230 / 400 V

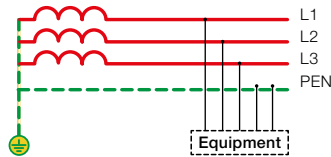

TNC-S networks
230 / 400 V

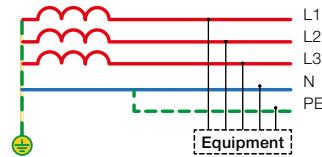

TNS networks
230 / 400 V

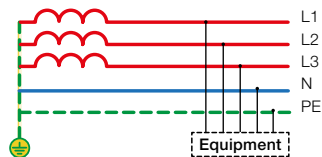

TT networks
230 / 400 V

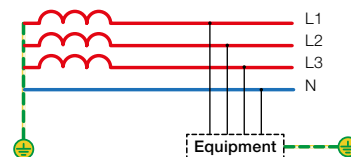

IT networks
230 / 400 / 600 V

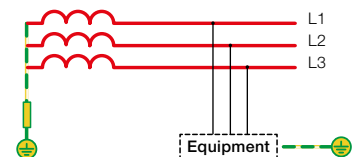

Wiring diagrams according to UL 1449

Single phase networks
120 / 240 / 277 V

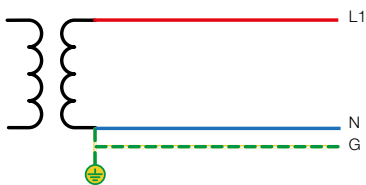

Split phase networks
240 / 120 V, 480 / 240 V



Delta networks
240 / 480 / 600 V

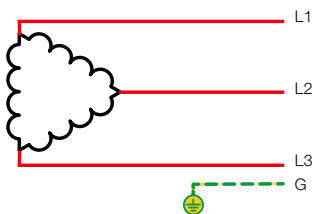

Grounded Wye networks
208 Y / 120 V, 480 Y / 277 V, 600 Y / 347 V

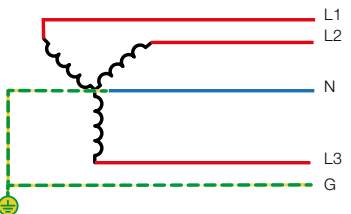

High-Leg Delta networks
240 / 1200 V HLD

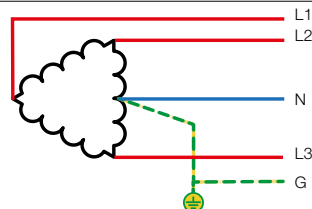

Surge and lightning protection solutions

Selection tool: TNC - 230 / 400 V network

1 Industry, commercial building

Configuration 1
 $15 \text{ kA} \leq I_p \leq 50 \text{ kA}$

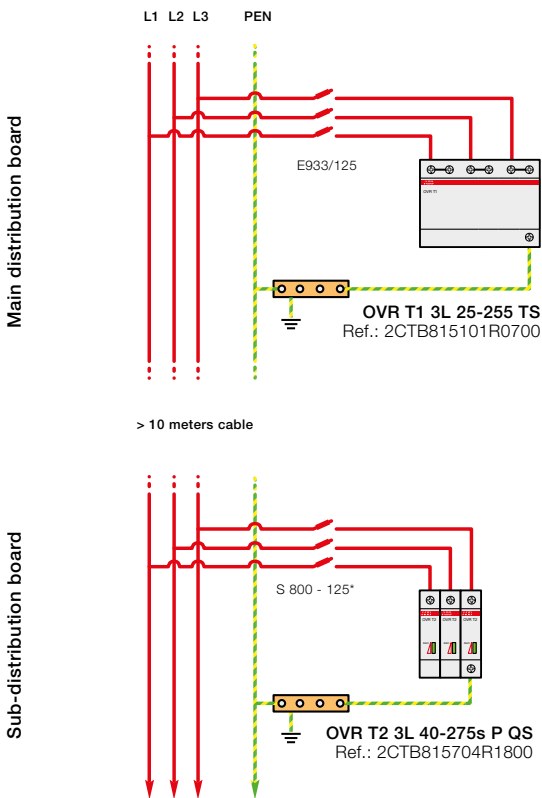

Configuration 2
 $I_p \leq 15 \text{ kA}$

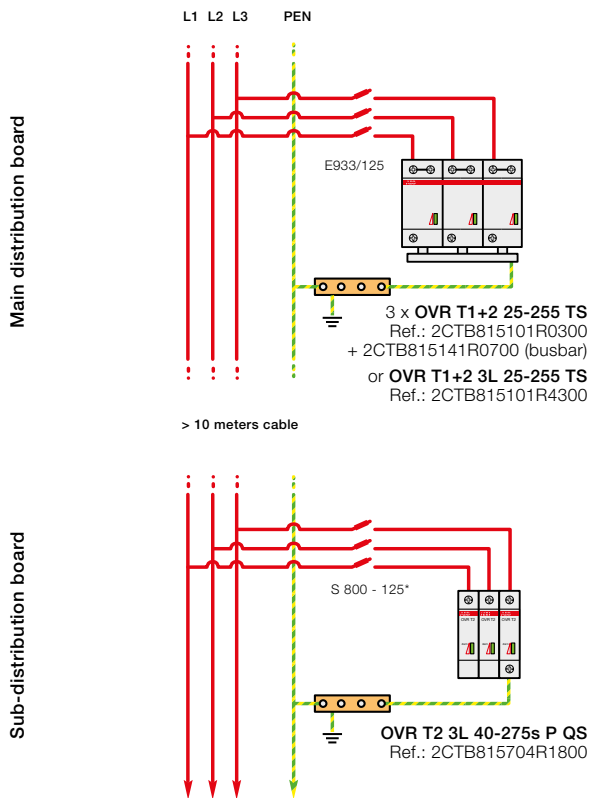

I_p : prospective short circuit current of the power supply.
 * Must be according to the coordination rules with main or upstream short circuit protection(s).

Surge and lightning protection solutions

Selection tool: TNC-S - 230 / 400 V network

Industry, commercial building

Configuration 1
 $15 \text{ kA} \leq I_p \leq 50 \text{ kA}$

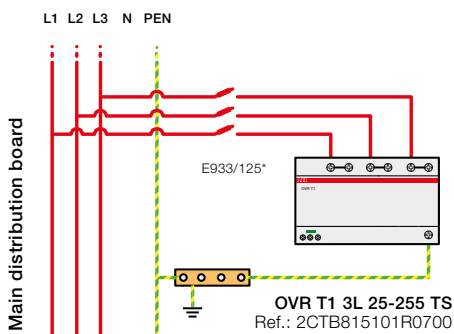

> 10 meters cable

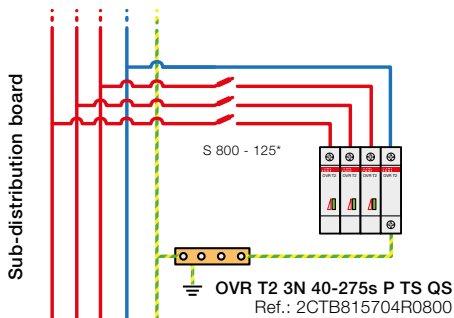

> 10 meters cable

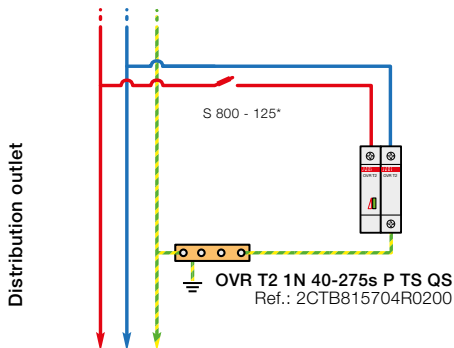

Configuration 2
 $7 \text{ kA} \leq I_p \leq 15 \text{ kA}$

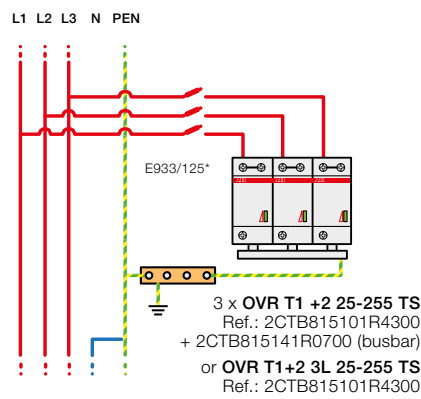

> 10 meters cable

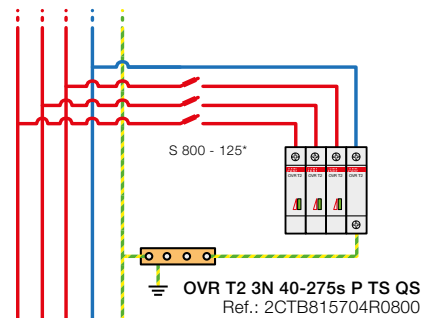

> 10 meters cable

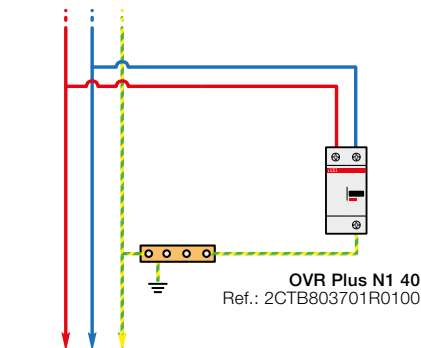

Configuration 3
 $I_p \leq 7 \text{ kA}$

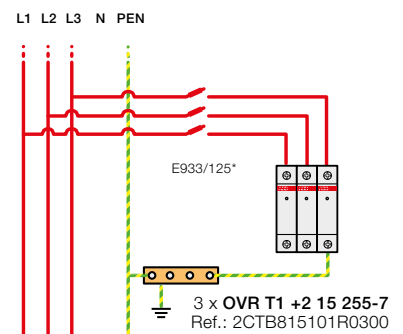

> 10 meters cable

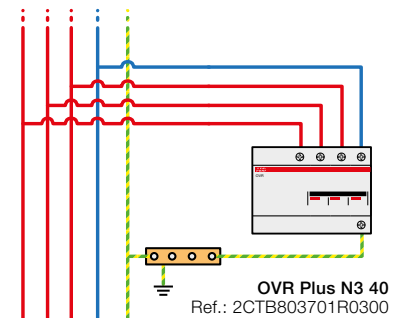

> 10 meters cable

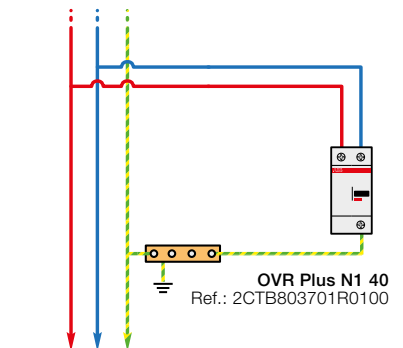

I_p : prospective short circuit current of the power supply.

* Must be according to the coordination rules with main or upstream short circuit protection(s).

Surge and lightning protection solutions

Selection tool: TT - 230 / 400 V network

1 Industry, commercial building

Configuration 1
 $15 \text{ kA} \leq I_p \leq 50 \text{ kA}$

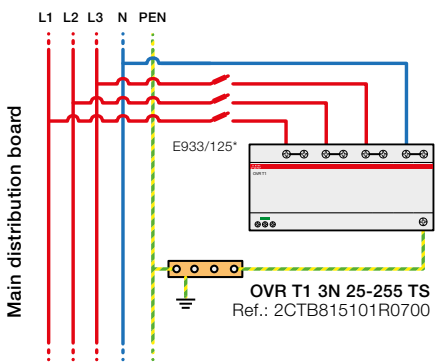

> 10 meters cable

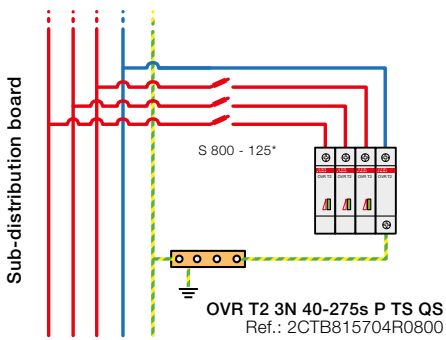

> 10 meters cable

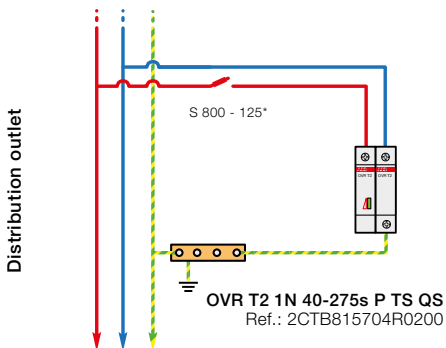

Configuration 2
 $7 \text{ kA} \leq I_p \leq 15 \text{ kA}$

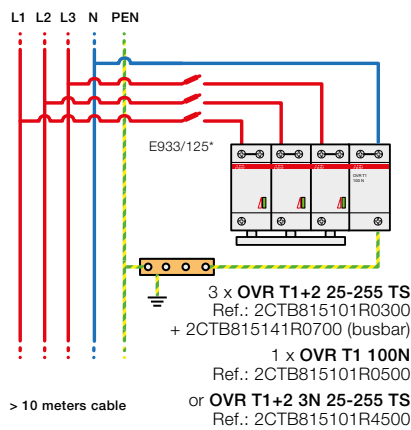

> 10 meters cable

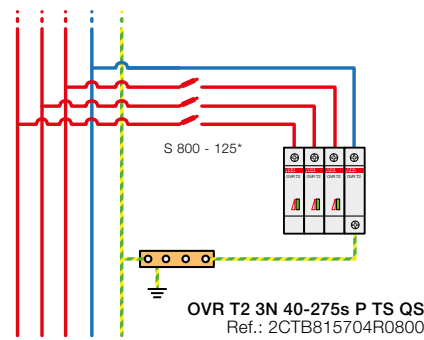

> 10 meters cable

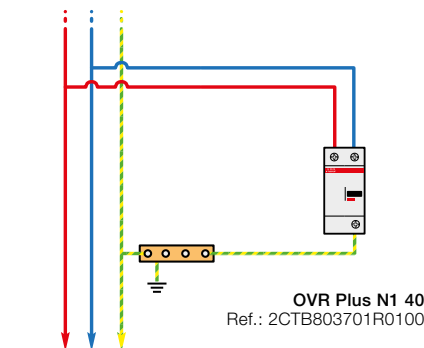

Configuration 3
 $I_p \leq 7 \text{ kA}$

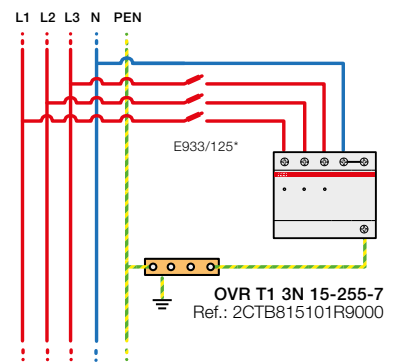

> 10 meters cable

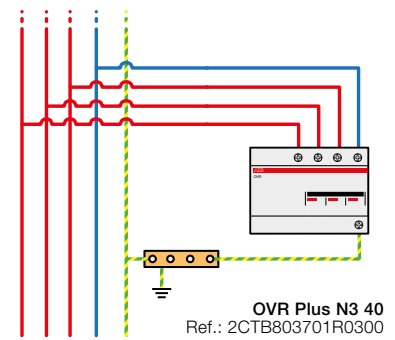

> 10 meters cable

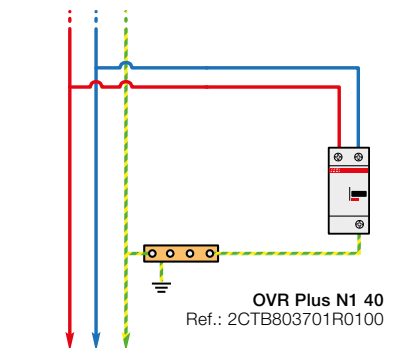

I_p : prospective short circuit current of the power supply.
 * Must be according to the coordination rules with main or upstream short circuit protection(s).

Surge and lightning protection solutions

Selection tool: IT - 230 V network without neutral

Commercial, residential

The IT system has all live parts at the source isolated from earth or one part connected to earth with a high impedance.

Configuration 1

$I_p \leq 100 \text{ kA}$

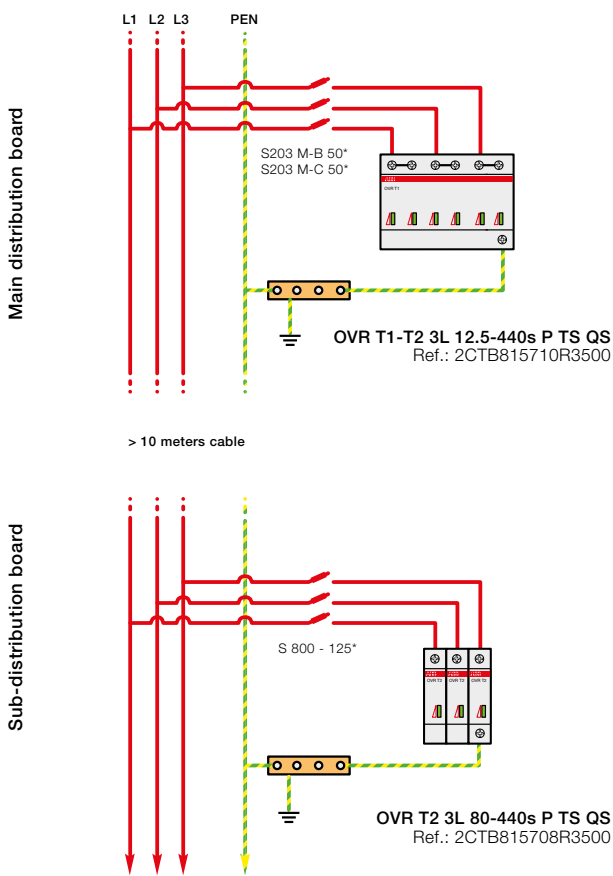

Configuration 2

$I_p \leq 15 \text{ kA}$

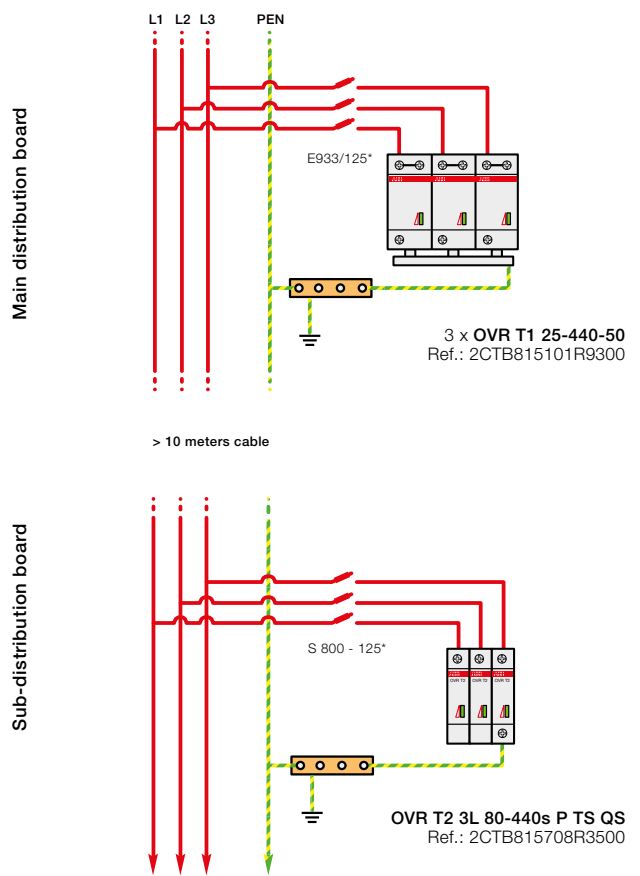

I_p : prospective short circuit current of the power supply.

* Must be according to the coordination rules with main or upstream short circuit protection(s).

Surge and lightning protection solutions

Selection tool: TNC, TNS - TT - 230 / 400 V networks

1

Residential

With external conductive parts (external lightning protection air terminal, antenna...) or powered by aerial lines

YES



NO



Neighbour with external lightning protection system (or generally with earthed extraneous conductive parts), or proximity of high points

YES

NO



Configuration 1

With risk of direct lightning current (external protection, aerial lines...)

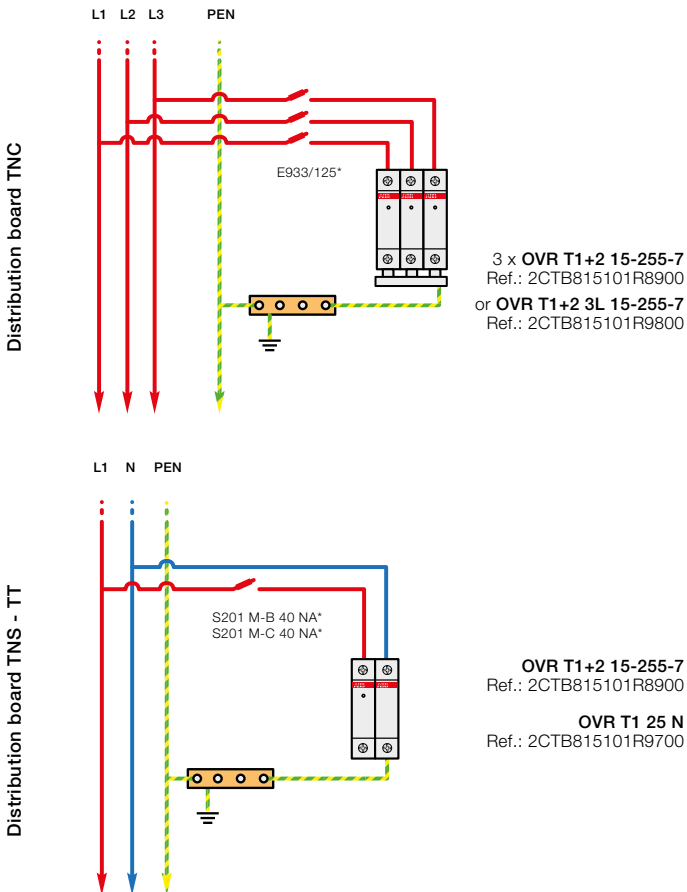

* Should be according to the coordination rules with installed main breakers.

Configuration 2

Without risk of indirect lightning current, transient surges

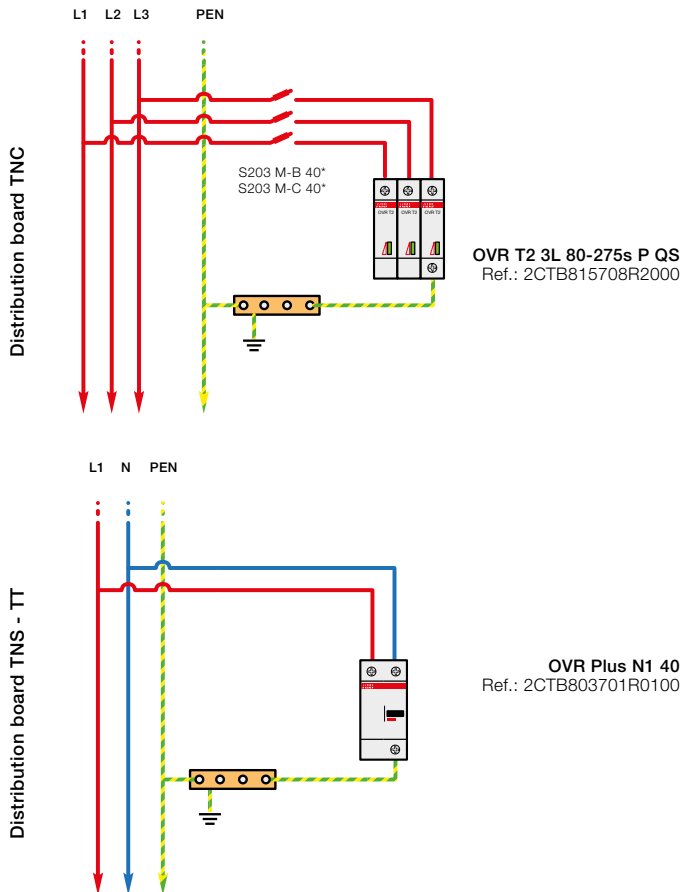

OVR surge protective devices - IEC version

Selection tables 32

Ordering details and general technical data

OVR Type 1 surge protective devices

Single pole	38
TNC - 230 V networks	40
TNS - TT - 230 V - 1Ph+N networks	42
TNS - TT - 230 V - 3Ph+N networks	44
Single pole neutral	46

OVR Type 1+2 surge protective devices

Single pole	48
TNC - 230 and 400 V networks	50
TNS - TT - 230 and 400 V - 1Ph+N and 3Ph+N networks	53

OVR Type 2 surge protective devices

Single pole - 57 V networks	56
Single pole - Unpluggable - 120 V and 230 V networks	58
Single pole - Pluggable - 230 V networks	61
Single pole - 400 V networks	65
TNC - 230 V networks	68
TNC - 400 V networks	70
TNS - 230 V networks	72
TNS - 400 V networks	74
TNS - TT - 230 V - 1Ph+N networks	76
TNS - TT - 230 and 400 V - 3Ph+N networks	79

OVR Type 2-3 surge protective devices

Single pole - 230 and 400 V networks	82
TNC - 230 V - 3Ph+PEN networks	84
TNS - TT - 230 V - 1Ph+N network	86
TT - 230 V and 400 V - 3Ph+N networks	88

OVR Type 3 surge protective devices

TNS - TT - 230 V networks	90
---------------------------	----

OVR for applications

OVR Plus autoprotected surge protective devices	
TNS - TT - 230 V networks	92
OVR Type 2-3 surge protective devices - StreetLight applications	
TT - TN - 230 V networks	94
OVR PV surge protective devices - Photovoltaic applications	96
OVR WT surge protective devices - Wind turbine applications	98
OVR TC surge protective devices - Dataline protection	100

Accessories for OVR 102

OVR surge protective devices - IEC version

Selection tables

2

Protected lines	Impulse current <i>I_{imp}</i> 10 / 350 kA	Max. discharge current <i>I_{max}</i> 8 / 20 kA	Nominal discharge current <i>I_n</i> kA	Follow current interrupting rating <i>I_{fi}</i> kA	Voltage protection level <i>U_p</i> kV	Nominal voltage <i>U_n</i> V	Max. cont. operating voltage <i>U_c</i> V	Type	Order codes
-----------------	--	---	---	---	--	--	---	------	-------------

Type 1 - Unpluggable

Uc 255 V

1	25	60	25	50	2.5	230	255	OVR T1 25-255	2CTB815101R0100
1	25	60	25	7	2.5	230	255	OVR T1 25-255-7	2CTB815101R8700
2	25	60	25	50	2.5	230 / 400	255	OVR T1 2L 25-255	2CTB815101R1200
2	25	60	25	50	2.5	230 / 400	255	OVR T1 2L 25-255 TS	2CTB815101R1100
3	25	60	25	50	2.5	230 / 400	255	OVR T1 3L 25-255	2CTB815101R1300
3	25	60	25	50	2.5	230 / 400	255	OVR T1 3L 25-255 TS	2CTB815101R0600
4	25	60	25	50	2.5	230 / 400	255	OVR T1 4L 25-255	2CTB815101R1400
4	25	60	25	50	2.5	230 / 400	255	OVR T1 4L 25-255 TS	2CTB815101R0800
1+1	25	60	25	50	2.5	230	255	OVR T1 1N 25-255	2CTB815101R1500
1+1	25	60	25	50	2.5	230	255	OVR T1 1N 25-255 TS	2CTB815101R1000
3+1	25	60	25	50	2.5	230 / 400	255	OVR T1 3N 25-255	2CTB815101R1600
3+1	25	60	25	50	2.5	230 / 400	255	OVR T1 3N 25-255 TS	2CTB815101R0700
3+1	25	60	25	7	2	230 / 400	255	OVR T1 3N 25-255-7	2CTB815101R8800

Uc 440 V

1	25	60	25	50	2.5	400	440	OVR T1 25-440-50	2CTB815101R9300
---	----	----	----	----	-----	-----	-----	------------------	-----------------

Neutral

1	25	60	25	0.1	4	440	690	OVR T1 25 N	2CTB815101R9700
1	50	100	25	0.1	1.5	230	255	OVR T1 50 N	2CTB815101R0400
1	100	100	25	0.1	2	230	255	OVR T1 100 N	2CTB815101R0500

Type 1+2

Uc 255-275 V

1	12.5	80	30	-	1.1	230	275	OVR T1-T2 12.5-275s P QS*	2CTB815710R1200
1	12.5	80	30	-	1.1	230	275	OVR T1-T2 12.5-275s P TS QS*	2CTB815710R0000
3	12.5	80	30	-	1.1	230 / 400	275	OVR T1-T2 3L 12.5-275s P QS*	2CTB815710R1800
3	12.5	80	30	-	1.1	230 / 400	275	OVR T1-T2 3L 12.5-275s P TS QS*	2CTB815710R0600
4	12.5	80	30	-	1.1	230 / 400	275	OVR T1-T2 4L 12.5-275s P QS*	2CTB815710R2300
4	12.5	80	30	-	1.1	230 / 400	275	OVR T1-T2 4L 12.5-275s P TS QS*	2CTB815710R1100
3+1	12.5	80	30	-	1.3	230 / 400	275	OVR T1-T2 3N 12.5-275s P QS*	2CTB815710R1900
3+1	12.5	80	30	-	1.3	230 / 400	275	OVR T1-T2 3N 12.5-275s P TS QS*	2CTB815710R0700
1+1	12.5	80	30	-	1.3	230	275	OVR T1-T2 1N 12.5-275s P QS*	2CTB815710R1300
1+1	12.5	80	30	-	1.3	230	275	OVR T1-T2 1N 12.5-275s P TS QS*	2CTB815710R0100
1	15	60	15	7	1.7	230	255	OVR T1+2 15-255-7	2CTB815101R8900
3+1	15	60	15	7	1.5	230 / 400	255	OVR T1+2 3N 15-255-7	2CTB815101R9000
1	25	60	25	15	1.5	230	255	OVR T1+2 25-255 TS	2CTB815101R0300
3	25	60	25	-	1.5	230 / 240	255	OVR T1+2 3L 25-255 TS	2CTB815101R4300
4	25	60	25	15	1.5	230 / 240	255	OVR T1+2 4L 25-255 TS	2CTB815101R4200
1+1	25	60	25	15	1.5	230	255	OVR T1+2 1N 25-255 TS	2CTB815101R4400
3+1	25	60	25	15	1.5	230 / 400	255	OVR T1+2 3N 25-255 TS	2CTB815101R4500

Uc 440 V

1	12.5	80	30	-	1.6	400	440	OVR T1-T2 12.5-440s P QS*	2CTB815710R4100
1	12.5	80	30	-	1.6	400	440	OVR T1-T2 12.5-440s P TS QS*	2CTB815710R2900
1+1	12.5	80	30	-	1.8	400	440	OVR T1-T2 1N 12.5-440s P QS*	2CTB815710R4200
1+1	12.5	80	30	-	1.8	400	440	OVR T1-T2 1N 12.5-440s P TS QS*	2CTB815710R3000
3	12.5	80	30	-	1.8	400 / 690	440	OVR T1-T2 3L 12.5-440s P QS*	2CTB815710R4700
3	12.5	80	30	-	1.8	400 / 690	440	OVR T1-T2 3L 12.5-440s P TS QS*	2CTB815710R3500
3+1	12.5	80	30	-	1.8	400 / 690	440	OVR T1-T2 3N 12.5-440s P QS*	2CTB815710R4800
3+1	12.5	80	30	-	1.8	400 / 690	440	OVR T1-T2 3N 12.5-440s P TS QS*	2CTB815710R3600
4	12.5	80	30	-	1.8	400 / 690	440	OVR T1-T2 4L 12.5-440s P QS*	2CTB815710R5200
4	12.5	80	30	-	1.8	400 / 690	440	OVR T1-T2 4L 12.5-440s P TS QS*	2CTB815710R4000

Neutral

1	50	80	30	-	1	230	275	OVR T1-T2 N 50-275s P QS*	2CTB815710R2400
1	50	80	30	-	1	400	440	OVR T1-T2 N 50-440s P QS*	2CTB815710R5300

Cartridges

1	12.5	80	30	-	1.1	230	275	OVR T1-T2 12.5-275s C QS*	2CTB815710R2600
1	12.5	80	30	-	1.6	400	440	OVR T1-T2 12.5-440s C QS*	2CTB815710R5500
1	50	80	30	-	1	230	275	OVR T1-T2 N 50-275s C QS*	2CTB815710R2700
1	50	80	30	-	1	400	440	OVR T1-T2 N 50-440s C QS*	2CTB815710R2700

* Products available end 2015.

Protected lines	Impulse current Iimp 10 / 350 kA	Max. discharge current Imax 8 / 20 kA	Nominal discharge current In kA	Follow current interrupting rating Ifi kA	Voltage protection level Up kV	Nominal voltage Un V	Max. cont. operating voltage Uc V	Type	Order codes
Type 2 - Unpluggable									
Uc 150 V									
1	-	20	5	-	0.6	120 (±15%)	150	OVR T2 20-150	2CTB804200R0700
1	-	20	5	-	0.6	120 (±15%)	150	OVR T2 20-150 (x20)	2CTB804200R1700
1	-	40	20	-	0.9	120 (±15%)	150	OVR T2 40-150	2CTB804201R0700
1	-	40	20	-	0.9	120 (±15%)	150	OVR T2 40-150 (x20)	2CTB804201R1700
Uc 275 V									
1	-	20	5	-	1	230	275	OVR T2 20-275	2CTB804200R0100
1	-	20	5	-	1	230	275	OVR T2 20-275 (x20)	2CTB804200R1100
3	-	20	5	-	1	230 / 400	275	OVR T2 3L 20-275	2CTB804600R0400
3	-	20	5	-	1	230 / 400	275	OVR T2 3L 20-275 (x6)	2CTB804600R1400
4	-	20	5	-	1	230 / 400	275	OVR T2 4L 20-275 (x5)	2CTB804600R1500
1	-	40	20	-	1.4	230	275	OVR T2 40-275	2CTB804201R0100
1	-	40	20	-	1.4	230	275	OVR T2 40-275 (x20)	2CTB804201R1100
3	-	40	20	-	1.4	230 / 400	275	OVR T2 3L 40-275	2CTB804601R0400
3	-	40	20	-	1.4	230 / 400	275	OVR T2 3L 40-275 (x6)	2CTB804601R1400
4	-	40	20	-	1.4	230 / 400	275	OVR T2 4L 40-275	2CTB804601R0500
4	-	40	20	-	1.4	230 / 400	275	OVR T2 4L 40-275 (x5)	2CTB804601R1500
Uc 440 V									
1	-	20	5	-	1.3	400	440	OVR T2 20-440	2CTB804200R0200
1	-	20	5	-	1.3	400	440	OVR T2 20-440 (x20)	2CTB804200R1200
1	-	40	20	-	1.9	400	440	OVR T2 40-440	2CTB804201R0200
1	-	40	20	-	1.9	400	440	OVR T2 40-440 (x20)	2CTB804201R1200
Type 2 - Pluggable									
Uc 75 V									
1	-	20	5	-	0.3	57	75	OVR T2 20-75 P	2CTB803851R2800
1	-	20	5	-	0.3	57	75	OVR T2 20-75 P TS	2CTB803851R2700
2	-	20	5	-	0.3	57	75	OVR T2 2 20-75 P	2CTB803852R1700
2	-	20	5	-	0.3	57	75	OVR T2 2 20-75 P TS	2CTB803852R1600
Uc 275 V									
1	2	40	20	-	1.25	230	275	OVR T2 40-275 P QS	2CTB803871R2300
1	2	40	20	-	1.25	230	275	OVR T2 40-275 P TS QS	2CTB803871R1700
1	2	40	20	-	1.5	230	275	OVR T2 40-275s P QS	2CTB815704R1200
1	2	40	20	-	1.5	230	275	OVR T2 40-275s P TS QS*	2CTB815704R0000
3	2	40	20	-	1.25	230 / 400	275	OVR T2 3L 40-275 P QS	2CTB803873R2400
3	2	40	20	-	1.25	230 / 400	275	OVR T2 3L 40-275 P TS QS	2CTB803873R2500
3	2	40	20	-	1.5	230 / 400	275	OVR T2 3L 40-275s P QS*	2CTB815704R1800
3	2	40	20	-	1.5	230 / 400	275	OVR T2 3L 40-275s P TS QS*	2CTB815704R0600
4	2	40	20	-	1.25	230 / 400	275	OVR T2 4L 40-275 P QS	2CTB803873R5600
4	2	40	20	-	1.25	230 / 400	275	OVR T2 4L 40-275 P TS QS	2CTB803873R5200
4	2	40	20	-	1.5	230 / 400	275	OVR T2 4L 40-275s P QS*	2CTB815704R2300
4	2	40	20	-	1.5	230 / 400	275	OVR T2 4L 40-275s P TS QS*	2CTB815704R1100
1+1	2	40	20	-	1.25	230	275	OVR T2 1N 40-275 P QS	2CTB803972R1100
1+1	2	40	20	-	1.25	230	275	OVR T2 1N 40-275 P TS QS	2CTB803972R0500
1+1	2	40	20	-	1.3	230	275	OVR T2 1N 40-275s P QS*	2CTB815704R1400
1+1	2	40	20	-	1.3	230	275	OVR T2 1N 40-275s P TS QS*	2CTB815704R0200
3+1	2	40	20	-	1.5	230 / 400	275	OVR T2 3N 40-275 P QS	2CTB803973R1100
3+1	2	40	20	-	1.5	230	275	OVR T2 3N 40-275 P TS QS	2CTB803973R0500
3+1	2	40	20	-	1.5	230	275	OVR T2 3N 40-275s P QS*	2CTB815704R2000
3+1	2	40	20	-	1.5	230	275	OVR T2 3N 40-275s P TS QS*	2CTB815704R0800
1	6.25	80	30	-	1.8	230	275	OVR T2 80-275s P QS*	2CTB815708R1200
1	6.25	80	30	-	1.8	230	275	OVR T2 80-275s P TS QS*	2CTB815708R0000
3	6.25	80	30	-	1.8	230 / 400	275	OVR T2 3L 80-275s P QS*	2CTB815708R1800
3	6.25	80	30	-	1.8	230 / 400	275	OVR T2 3L 80-275s P TS QS*	2CTB815708R0600
4	6.25	80	30	-	1.8	230 / 400	275	OVR T2 4L 80-275s P QS*	2CTB815708R2300
4	6.25	80	30	-	1.8	230 / 400	275	OVR T2 4L 80-275s P TS QS*	2CTB815708R1100
1+1	6.25	80	30	-	1.8	230	275	OVR T2 1N 80-275s P QS*	2CTB815708R1400
1+1	6.25	80	30	-	1.8	230	275	OVR T2 1N 80-275s P TS QS*	2CTB815708R0200
3+1	6.25	80	30	-	1.8	230 / 400	275	OVR T2 3N 80-275s P QS*	2CTB815708R2000
3+1	6.25	80	30	-	1.8	230	275	OVR T2 3N 80-275s P TS QS*	2CTB815708R0800
Neutral									
1	-	80	30	-	1.4	230	275	OVR T2 N 80-275 P QS	2CTB803973R1900
1	-	80	30	-	1.8	230	275	OVR T2 N 80-275s P QS*	2CTB815708R2500
Cartridges									
1	-	40	20	-	1.25	230	275	OVR T2 40-275 C QS	2CTB803876R1000
1	-	40	20	-	1.5	230	275	OVR T2 40-275s C QS*	2CTB815704R2600
1	-	80	30	-	1.4	230	275	OVR T2 N 80-275 C QS	2CTB803876R0000
1	-	80	30	-	1.8	230	275	OVR T2 80-275s C QS*	2CTB815708R2600
1	-	80	30	-	1.8	230	275	OVR T2 N 80-275s C QS*	2CTB815708R2800

* Products available on end 2015.

(x5) packaging of 5 pieces. (x6) packaging of 6 pieces. (x20) packaging of 20 pieces.

OVR surge protective devices - IEC version

Selection tables

2

Protected lines	Impulse current I_{imp} 10/350 kA	Max. discharge current I_{max} 8/20 kA	Nominal discharge current I_n kA	Follow current interrupting rating I_{fi} kA	Voltage protection level U_p kV	Nominal voltage U_n V	Max. cont. operating voltage U_c V	Type	Order code
-----------------	---	--	--	--	---	-------------------------------	--	------	------------

Type 2 - Pluggable

Uc 350 V

1	2	40	20	-	1.5	230	350	OVR T2 40-350 P QS	2CTB803881R2300
1	2	40	20	-	1.5	230	350	OVR T2 40-350 P TS QS	2CTB803881R1700
1+1	2	40	20	-	1.7	230	350	OVR T2 1N 40-350 P QS	2CTB803982R1100
1+1	2	40	20	-	1.7	230	350	OVR T2 1N 40-350 P TS QS	2CTB803982R0500
3	2	40	20	-	1.5	230 / 400	350	OVR T2 3L 40-350 P QS	2CTB803883R2400
3	2	40	20	-	1.5	230 / 400	350	OVR T2 3L 40-350 P TS QS	2CTB803883R2500
3+1	2	40	20	-	1.7	230 / 400	350	OVR T2 3N 40-350 P QS	2CTB803983R1100
3+1	2	40	20	-	1.7	230 / 400	350	OVR T2 3N 40-350 P TS QS	2CTB803983R0500

Neutral

1	-	80	30	-	1.4	230	275	OVR T2 N 80-275 P QS	2CTB803973R1900
1	-	80	30	-	1.4	230	350	OVR T2 N 80-350 P QS	2CTB803983R1900

Cartridges

1	-	40	20	-	1.5	230	350	OVR T2 40-350 C QS	2CTB803886R1000
1	-	80	30	-	1.4	230	350	OVR T2 N 80-350 C QS	2CTB803886R0000

Uc 440 V

1	2	40	20	-	1.8	400	440	OVR T2 40-440 P QS	2CTB803871R1200
1	2	40	20	-	1.8	400	440	OVR T2 40-440 P TS QS	2CTB803871R0500
1	2	40	20	-	2	400	440	OVR T2 40-440s P QS*	2CTB815704R4100
1	2	40	20	-	2	400	440	OVR T2 40-440s P TS QS*	2CTB815704R2900
3	2	40	20	-	1.8	400 / 690	440	OVR T2 3L 40-440 P QS	2CTB803873R2800
3	2	40	20	-	1.8	400 / 690	440	OVR T2 3L 40-440 P TS QS	2CTB803873R2700
4	2	40	20	-	1.8	400 / 690	440	OVR T2 4L 40-440 P QS	2CTB803873R5100
4	2	40	20	-	1.8	400 / 690	440	OVR T2 4L 40-440 P TS QS	2CTB803873R5300
3+1	2	40	20	-	2.1	400 / 690	440	OVR T2 3N 40-440 P QS	2CTB803973R1400
3+1	2	40	20	-	2.1	400 / 690	440	OVR T2 3N 40-440 P TS QS	2CTB803973R1500
3+1	2	40	20	-	2	400 / 690	440	OVR T2 3N 40-440s P TS QS*	2CTB815704R3700
1	-	60	60	-	2.5	400	440	OVR T2 120-440s P TS	2CTB803951R1300
1	6.25	80	30	-	2.4	400	440	OVR T2 80-440s P QS*	2CTB815708R4100
1	6.25	80	30	-	2.4	400	440	OVR T2 80-440s P TS QS*	2CTB815708R2900
3	6.25	80	30	-	2.4	400 / 690	440	OVR T2 3L 80-440s P QS*	2CTB815708R4700
3	6.25	80	30	-	2.4	400 / 690	440	OVR T2 3L 80-440s P TS QS*	2CTB815708R3500
4	6.25	80	30	-	2.4	400 / 690	440	OVR T2 4L 80-440s P QS*	2CTB815708R5200
4	6.25	80	30	-	2.4	400 / 690	440	OVR T2 4L 80-440s P TS QS*	2CTB815708R4000
3+1	6.25	80	30	-	2.4	400 / 690	440	OVR T2 3N 80-440s P QS*	2CTB815708R4900
3+1	6.25	80	30	-	2.4	400 / 690	440	OVR T2 3N 80-440s P TS QS*	2CTB815708R3700

Neutral

1	-	80	30	-	1	400	440	OVR T2 N 80-440s P QS*	2CTB815708R5400
1	-	80	30	-	1.4	400	440	OVR T2 N 80-440 P QS	2CTB803973R2000

Cartridges

1	2	40	20	-	1.5	400	440	OVR T2 40-440s C QS*	2CTB815704R5500
1	2	80	40	-	2.4	400	440	OVR T2 40-440 C QS	2CTB803876R0400
1	6.25	80	30	-	1.8	400	440	OVR T2 80-440s C QS*	2CTB815708R5500
1	6.25	80	30	-	1.8	400	440	OVR T2 N 80-440 C QS	2CTB803886R0100
1	6.25	80	30	-	1	400	440	OVR T2 N 80-440s C QS*	2CTB815708R5700

Uc 600 V

1	2	40	20	-	2.3	400	600	OVR T2 40-600 P TS QS	2CTB803881R0500
3	2	40	20	-	2.3	400 / 690	600	OVR T2 3L 40-600 P TS QS	2CTB803883R2700
4	2	40	20	-	2.3	400 / 690	600	OVR T2 4L 40-600 P TS QS	2CTB803883R5300

Uc 760 V

3	-	40	15	-	2.9	400 / 690	440	OVR T2 3L 40-400/690 P	2CTB803853R4500
3	-	40	15	-	2.9	400 / 690	440	OVR T2 3L 40-400/690 P TS	2CTB803853R4600

Cartridges

1	-	40	20	-	2.9	400 / 690	440	OVR T2 40-400/690 C	2CTB803854R1100
---	---	----	----	---	-----	-----------	-----	---------------------	-----------------

* Products available end 2015.

Protected lines	Impulse current I _{imp} 10/350 kA	Max. discharge current I _{max} 8/20 kA	Nominal discharge current I _n kA	Follow current interrupting rating I _{fi} kA	Voltage protection level U _p kV	Nominal voltage U _n V	Max. cont. operating voltage U _c V	Type	Order code
-----------------	--	---	---	---	--	--	---	------	------------

Type 2-3 - Pluggable

Uc 275 V

1	2	20	5	-	0.9	230	275	OVR T2-T3 20-275 P QS	2CTB803871R2400
1	2	20	5	-	0.9	230	275	OVR T2-T3 20-275 P TS QS	2CTB803871R2500
1+1	2	20	5	-	1.4	230	275	OVR T2-T3 1N 20-275 P QS	2CTB803972R1200
1+1	2	20	5	-	1.4	230	275	OVR T2-T3 1N 20-275 P TS QS	2CTB803972R1300
3	2	20	5	-	0.85	230 / 400	275	OVR T2-T3 3L 20-275 P QS	2CTB803873R3400
3	2	20	5	-	0.85	230 / 400	275	OVR T2-T3 3L 20-275 P TS QS	2CTB803873R3500
3+1	2	20	5	-	1.4	230 / 400	275	OVR T2-T3 3N 20-275 P QS	2CTB803973R1200
3+1	2	20	5	-	1.4	230 / 400	275	OVR T2-T3 3N 20-275 P TS QS	2CTB803973R1600

Neutral

1	-	80	30	-	1.4	230	275	OVR T2 N 80-275 P QS	2CTB803973R1900
---	---	----	----	---	-----	-----	-----	----------------------	-----------------

Cartridges

1	-	20	5	-	1.4	230	275	OVR T2 20-275 C QS	2CTB803876R1200
1	-	80	30	-	1.4	230 / 400	275	OVR T2 N 80-275 C QS	2CTB803876R0000

Uc 440 V

1+1	2	20	5	-	1.4	400	440	OVR T2-T3 20-440 P QS	2CTB803871R1100
1+1	2	20	5	-	1.4	400	440	OVR T2-T3 20-440 P TS QS	2CTB803871R1300
3+1	2	20	5	-	1.4	400 / 690	440	OVR T2-T3 3N 20-440 P QS	2CTB803973R1300

Neutral

1	-	80	30	-	1.4	400	440	OVR T2 N 80-440 P QS	2CTB803973R2000
---	---	----	----	---	-----	-----	-----	----------------------	-----------------

Cartridges

1	-	80	5	-	1.4	400	440	OVR T2 20-440 C QS	2CTB803876R0600
1	-	80	30	-	1.4	400	440	OVR T2 N 80-440 C QS	2CTB803886R0100

Type 3 - Unpluggable

Combination wave Uoc 6 kV

1+1	-	10	3	-	0.9	230	275	OVR 1N 10 275	2CTB813912R1000
3+1	-	10	3	-	0.9	230 / 400	275	OVR 3N 10 275	2CTB813913R1000

Type 2 - Autoprotected

1+1	-	20	5	-	1.3	230	275	OVR PLUS N1 20	2CTB803701R0700
1+1	-	40	20	-	1.6	230	275	OVR PLUS N1 40	2CTB803701R0100
3+1	-	20	5	-	1.3	230 / 400	275	OVR PLUS N3 20	2CTB803701R0400
3+1	-	40	20	-	1.5	230 / 400	275	OVR PLUS N3 40	2CTB803701R0300

(x20) packaging of 20 pieces.

OVR surge protective devices - IEC version

Selection tables

2

Protected lines	Impulse current Iimp 10/350 kA	Max. discharge current Imax 8/20 kA	Nominal discharge current In kA	Short circuit withstand Isscr/Iscpv kA	Voltage protection level Up kV	Nominal voltage Un V	Max. cont. operating voltage Uc V	Type	Order code
-----------------	--------------------------------------	---	---------------------------------------	--	--------------------------------------	----------------------------	---	------	------------

Type 1 - Pluggable - Photovoltaic applications

Uc 600 V DC

2	6.25	-	6.25	0.3 (Iscpv)	1.9	600	670	OVR PV T1 6.25-600 P TS	2CTB803953R5700
---	------	---	------	-------------	-----	-----	-----	-------------------------	-----------------

Cartridges

2	6.25	-	6.25	0.3 (Iscpv)	1.9	600	670	OVR PV T1 6.25-600 C	2CTB803950R1000
---	------	---	------	-------------	-----	-----	-----	----------------------	-----------------

Uc 1000 V DC

2	6.25	-	6.25	0.3 (Iscpv)	2.5	1000	1100	OVR PV T1 6.25-1000 P TS	2CTB803953R6700
---	------	---	------	-------------	-----	------	------	--------------------------	-----------------

Cartridges

2	6.25	-	6.25	0.3 (Iscpv)	2.5	1000	1100	OVR PV T1 6.25-1000 C	2CTB803950R1100
---	------	---	------	-------------	-----	------	------	-----------------------	-----------------

Type 2 - Pluggable - Photovoltaic applications

Uc 670 V DC

2	-	40	20	0.3 (Iscpv)	2.8	600	670	OVR PV 40-600 P	2CTB803953R5300
---	---	----	----	-------------	-----	-----	-----	-----------------	-----------------

2	-	40	20	0.3 (Iscpv)	2.8	600	670	OVR PV 40-600 P TS	2CTB803953R5400
---	---	----	----	-------------	-----	-----	-----	--------------------	-----------------

Cartridges

1+1 DC	-	40	20	0.3 (Iscpv)	2.8	600	670	OVR PV 40-600 C	2CTB803950R0000
--------	---	----	----	-------------	-----	-----	-----	-----------------	-----------------

Uc 1100 V DC

2	-	20	20	10 000 (Iscpv)	3.8 / 3.8	1000	1100	OVR PV T2 40-1000 P QS	2CTB804153R2400
---	---	----	----	----------------	-----------	------	------	------------------------	-----------------

2	-	40	20	10 000 (Iscpv)	3.8	1000	1100	OVR PV 40-1000 P	2CTB803953R6400
---	---	----	----	----------------	-----	------	------	------------------	-----------------

2	-	40	20	10 000 (Iscpv)	3.8	1000	1100	OVR PV 40-1000 P TS	2CTB803953R6500
---	---	----	----	----------------	-----	------	------	---------------------	-----------------

2	-	40	20	10 000 (Iscpv)	3.8	1000	1100	OVR PV 40-1000 P TS BW (x30)	2CTB804153R1900
---	---	----	----	----------------	-----	------	------	------------------------------	-----------------

Cartridges

1+1 DC	-	40	20	10 000 (Iscpv)	1.9	1000	1100	OVR PV 40-1000 C	2CTB803950R0100
--------	---	----	----	----------------	-----	------	------	------------------	-----------------

Uc 1500 V DC

2	-	40	15	10 000 (Iscpv)	4.5	1500	1500	OVR PV 40-1500 P BW	2CTB804153R2200
---	---	----	----	----------------	-----	------	------	---------------------	-----------------

2	-	40	15	10 000 (Iscpv)	4.5	1500	1500	OVR PV 40-1500 P TS BW	2CTB804153R2100
---	---	----	----	----------------	-----	------	------	------------------------	-----------------

Cartridges

1	-	40	20	10 000 (Iscpv)	4.5	1500	1500	OVR PV 40-1500 C	2CTB803950R2000
---	---	----	----	----------------	-----	------	------	------------------	-----------------

Type 1+2 - Pluggable - Wind turbine applications

Uc 690 V

3	2	40	20	-	6	400 / 690	690	OVR WT 3L 690 P TS	2CTB235402R0000
---	---	----	----	---	---	-----------	-----	--------------------	-----------------

Cartridges

1	2	40	20	-	6	400	440	OVR T2 40 440 C	2CTB803854R0400
---	---	----	----	---	---	-----	-----	-----------------	-----------------

Dataline protection - Pluggable

Uc 7 V DC

1 pair	-	10	5	-	0.015	6	7	OVR TC 06V P	2CTB804820R0000
--------	---	----	---	---	-------	---	---	--------------	-----------------

Cartridges

1 pair	-	10	5	-	0.015	6	7	OVR TC 06V C	2CTB804821R0000
--------	---	----	---	---	-------	---	---	--------------	-----------------

Uc 14 V DC

1 pair	-	10	5	-	0.02	12	14	OVR TC 12V P	2CTB804820R0100
--------	---	----	---	---	------	----	----	--------------	-----------------

Cartridges

1 pair	-	10	5	-	0.02	12	14	OVR TC 12V C	2CTB804821R0100
--------	---	----	---	---	------	----	----	--------------	-----------------

Uc 27 V DC

1 pair	-	10	5	-	0.035	24	27	OVR TC 24V P	2CTB804820R0200
--------	---	----	---	---	-------	----	----	--------------	-----------------

Cartridges

1 pair	-	10	5	-	0.035	24	27	OVR TC 24V C	2CTB804821R0200
--------	---	----	---	---	-------	----	----	--------------	-----------------

Uc 53 V DC

1 pair	-	10	5	-	0.07	48	53	OVR TC 48V P	2CTB804820R0300
--------	---	----	---	---	------	----	----	--------------	-----------------

Cartridges

1 pair	-	10	5	-	0.07	48	53	OVR TC 48V C	2CTB804821R0300
--------	---	----	---	---	------	----	----	--------------	-----------------

Uc 220 V DC

1 pair	-	10	5	-	0.7	200	220	OVR TC 200V P	2CTB804820R0400
--------	---	----	---	---	-----	-----	-----	---------------	-----------------

1 pair	-	10	5	-	0.4	200	220	OVR TC 200FR P	2CTB804820R0500
--------	---	----	---	---	-----	-----	-----	----------------	-----------------

Cartridges

1 pair	-	10	5	-	0.7	200	220	OVR TC 200V C	2CTB804821R0400
--------	---	----	---	---	-----	-----	-----	---------------	-----------------

1 pair	-	10	5	-	0.4	200	220	OVR TC 200FR C	2CTB804821R0500
--------	---	----	---	---	-----	-----	-----	----------------	-----------------

Type 2-3 - Unpluggable - StreetLight applications

1+1	-	15	5	-	1.1	230	275	OVR T2-T3 N1 15-275s SL	2CTB804500R0200
-----	---	----	---	---	-----	-----	-----	-------------------------	-----------------

1+1	-	15	5	-	1.1	230	275	OVR T2-T3 N1 15-275s SL (x20)	2CTB804500Z1200
-----	---	----	---	---	-----	-----	-----	-------------------------------	-----------------

(x30) packaging of 30 pieces.



2CTC438029S0201

OVR Type 1 surge protective devices - Single pole

2



OVR T1

Description

Type 1 surge protective devices are designed to discharge high current surges without any destruction of the installation. These surge protective devices are characterized by their capacity to withstand impulse current with 10/350 μ s wave form which simulate natural lightning current.

Type 1 SPDs can be installed at the entrance in the main switch board for a global protection of the electrical installation.

Ordering details

Protected lines	Impulse current <i>I_{imp}</i> 10/350 kA	Follow current interrupting rating <i>I_{fi}</i> kA	Voltage protection level <i>U_p</i> kV	Nominal voltage <i>U_n</i> V	Max. cont. operating voltage <i>U_c</i> V	Bbn 3660308 EAN	Type	Order code	Weight Pkg (1 pce) kg
-----------------	---	---	--	--	---	-----------------------	------	------------	-----------------------------

Follow current interrupting rating 7 kA - Unpluggable

1	25	7	2.5	230	255	514110	OVR T1 25-255-7	2CTB815101R8700	0.16
---	----	---	-----	-----	-----	--------	-----------------	-----------------	------

Follow current interrupting rating 50 kA - Unpluggable

1	25	50	2.5	400	440	514929	OVR T1 25-440-50	2CTB815101R9300	0.31
1	25	50	2.5	230	255	510877	OVR T1 25-255	2CTB815101R0100	0.31

Main dimensions mm

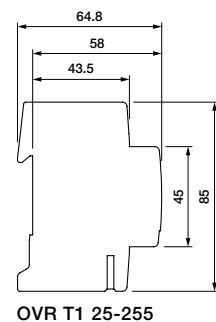
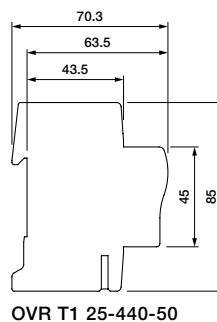
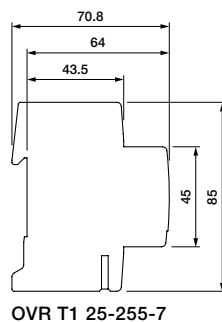

Type	Width mm
OVR T1 25-255-7	17.8
OVR T1 25-440-50	35.6
OVR T1 25-255	35.6

2CTC430001S0201

OVR Type 1 surge protective devices - Single pole

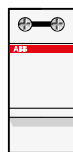

General technical data

	OVR T1 25-255-7	OVR T1 25-440-50	OVR T1 25-255
Types with auxiliary contact (TS)	–	–	–
Technology	Spark-gap	Spark-gap	Spark-gap
Electrical features			
Standard	IEC 61643-1 / EN 61643-11		
Type / test class	T1 / I	T1 / I	T1 / I
Protected lines	1	1	1
Types of networks	TNC - TNS - TT	IT - TNC - TNS - TT	TNC - TNS - TT
Type of current	AC	AC	AC
Nominal voltage Un	230 V	400 V	230 V
Maximum continuous operating voltage Uc	255 V	440 V	255 V
Maximum impulse current Iimp (10/350)	25 kA	25 kA	25 kA
Maximum impulse current Tot. Iimp (10/350)	25 kA	25 kA	25 kA
Nominal discharge current In (8/20)	25 kA	25 kA	25 kA
Follow current interrupting rating Iff	7 kA	50 kA	50 kA
Voltage protection level Up at In	≤ 2.5 kV	≤ 2.5 kV	≤ 2.5 kV
Voltage protection level Up at 3 kA	≤ 0.9 kV	≤ 1.3 kV	≤ 0.9 kV
TOV (Temporary overvoltage) withstand Ut (L-N: 5 s / N-PE: 200 ms)	650 V / –	690 V / –	450 V / –
Response time	≤ 100 ns	≤ 100 ns	≤ 100 ns
Residual current IPE	1000 µA	10 µA	10 µA
Short-circuit withstand capability Isccr	50 kA	50 kA	50 kA
Backup protection	Fuse (gG - gL) ≤ 125 A Circuit breaker (B or C curve) ≤ 125 A	≤ 125 A ≤ 125 A	≤ 125 A ≤ 125 A
Pluggable cartridge	No	No	No
Integrated thermal disconnect	–	–	–
State indicator	Yes	No	No
Safety reserve	No	No	No
Auxiliary contact (TS)	No	No	No
Installation			
Wire range (L, N, PE)	Solid wire 2.5...50 mm ² Stranded wire 2.5...35 mm ²	2.5...50 mm ² 2.5...35 mm ²	2.5...50 mm ² 2.5...35 mm ²
Stripping length (L, N, PE)	15 mm	15 mm	15 mm
Tightening torque (L, N, PE)	3.5 Nm	3.5 Nm	3.5 Nm
Auxiliary contact (TS)			
Contact complement	–	–	–
Minimum load	–	–	–
Maximum load	–	–	–
Connection cross-section	–	–	–
Miscellaneous characteristics			
Stocking and operating temperature	-40...+80 °C	-40...+80 °C	-40...+80 °C
Degree of protection	IP20	IP20	IP20
Fire resistance according to UL 94	V0	V0	V0
Dimensions	mm h x w x d 85 x 17.8 x 70.8 mm inches h x w x d 3.35 x 0.7 x 2.79 in	85 x 35.6 x 70.3 mm 3.35 x 1.4 x 2.77 in	85 x 35.6 x 64.8 mm 3.35 x 1.4 x 2.55 in
Dimensions with auxiliary contact (TS)	mm h x w x d – inches h x w x d –	–	–

OVR Type 1 surge protective devices

TNC - 230 V networks

2



2CSC400021F0013

OVR T1 3L 25-255

Description

Type 1 surge protective devices are designed to discharge high current surges without any destruction of the installation. These surge protective devices are characterized by their capacity to withstand impulse current with 10/350 μ s wave form which simulate natural lightning current.

Type 1 SPDs can be installed at the entrance in the main switch board for a global protection of the electrical installation.

Ordering details

Protected lines	Impulse current limp 10/350 kA	Follow current interrupting rating Ifi kA	Voltage protection level Up kV	Nominal voltage Un V	Max. cont. operating voltage Uc V	Bbn 3660308 EAN	Type	Order code	Weight Pkg (1 pce) kg
-----------------	---	---	--------------------------------------	----------------------------	---	-----------------------	------	------------	--------------------------------

Follow current interrupting rating 50 kA - Unpluggable

3	25	50	2.5	230/400	255	510907	OVR T1 3L 25-255	2CTB815101R1300	0.94
3	25	50	2.5	230/400	255	510952	OVR T1 3L 25-255 TS	2CTB815101R0600	1.00

Main dimensions mm

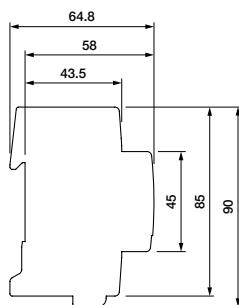

OVR T1 3L 25-255

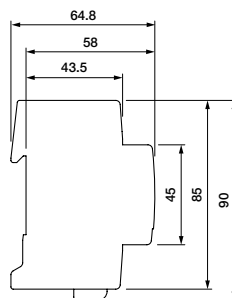

OVR T1 3L 25-255 TS

Type	Width mm
OVR T1 3L 25-255	106.8
OVR T1 3L 25-255 TS	124.6

2CTC430002S0201

OVR Type 1 surge protective devices

TNC - 230 V networks

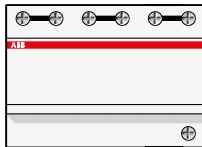

General technical data

	OVR T1 3L 25-255	-
Types	OVR T1 3L 25-255	-
with auxiliary contact (TS)	-	OVR T1 3L 25-255 TS
Technology	Spark-gap	Spark-gap
Electrical features		
Standard	IEC 61643-1 / EN 61643-11	
Type / test class	T1 / I	T1 / I
Protected lines	3	3
Types of networks	TNC	TNC
Type of current	AC	AC
Nominal voltage Un	230 / 400 V	230 / 400 V
Maximum continuous operating voltage Uc	255 V	255 V
Maximum impulse current Iimp (10/350)	25 kA	25 kA
Maximum impulse current Tot. Iimp (10/350)	75 kA	75 kA
Nominal discharge current In (8/20)	25 kA	25 kA
Follow current interrupting rating Iff	50 kA	50 kA
Voltage protection level Up at In	≤ 2.5 kV	≤ 2.5 kV
Voltage protection level Up at 3 kA	≤ 0.9 kV	≤ 0.9 kV
TOV (Temporary overvoltage) withstand Ut (L-N: 5 s / N-PE: 200 ms)	450 V / -	450 V / -
Response time	≤ 100 ns	≤ 100 ns
Residual current IPE	10 µA	10 µA
Short-circuit withstand capability Isccr	50 kA	50 kA
Backup protection	Fuse (gG - gL) ≤ 125 A Circuit breaker (B or C curve) ≤ 125 A	≤ 125 A ≤ 125 A
Pluggable cartridge	No	No
Integrated thermal disconnect	-	-
State indicator	No	Yes
Safety reserve	No	No
Auxiliary contact (TS)	No	Yes
Installation		
Wire range (L, N, PE)	Solid wire 2.5...50 mm ² Stranded wire 2.5...35 mm ²	2.5...50 mm ² 2.5...35 mm ²
Stripping length (L, N, PE)	15 mm	15 mm
Tightening torque (L, N, PE)	3.5 Nm	3.5 Nm
Auxiliary contact (TS)		
Contact complement	-	1 NO - 1 NC
Minimum load	-	12 V DC - 10 mA
Maximum load	-	250 V AC - 1 A
Connection cross-section	-	1.5 mm ²
Miscellaneous characteristics		
Stocking and operating temperature	-40...+80 °C	-40...+80 °C
Degree of protection	IP20	IP20
Fire resistance according to UL 94	V0	V0
Dimensions	mm h x w x d 90 x 106.8 x 64.8 mm inches h x w x d 3.54 x 4.2 x 2.55 in	- -
Dimensions with auxiliary contact (TS)	mm h x w x d - inches h x w x d -	90 x 124.6 x 64.8 mm 3.54 x 4.91 x 2.55 in

OVR Type 1 surge protective devices TNS - TT - 230 V - 1Ph+N networks

2



OVR T1 1N 25-255

Description

Type 1 surge protective devices are designed to discharge high current surges without any destruction of the installation. These surge protective devices are characterized by their capacity to withstand impulse current with 10/350 μ s wave form which simulate natural lightning current.

Type 1 SPDs can be installed at the entrance in the main switch board for a global protection of the electrical installation.

Ordering details

Protected lines	Impulse current limp 10/350 kA	Follow current interrupting rating Ifi kA	Voltage protection level Up kV	Nominal voltage Un V	Max. cont. operating voltage Uc V	Bbn 3660308 EAN	Type	Order code	Weight Pkg (1 pce) kg
-----------------	---	---	--------------------------------------	----------------------------	---	-----------------------	------	------------	--------------------------------

Follow current interrupting rating 50 kA - Unpluggable

1+1	25	50	2.5	230	255	510921	OVR T1 1N 25-255	2CTB815101R1500	0.53
1+1	25	50	2.5	230	255	510976	OVR T1 1N 25-255 TS	2CTB815101R1000	0.64
2	25	50	2.5	230/400	255	510891	OVR T1 2L 25-255	2CTB815101R1200	0.63
2	25	50	2.5	230/400	255	510945	OVR T1 2L 25-255 TS	2CTB815101R1100	0.64

Main dimensions mm

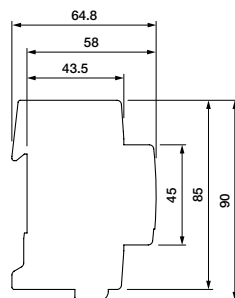

OVR T1 1N 25-255
OVR T1 2L 25-255

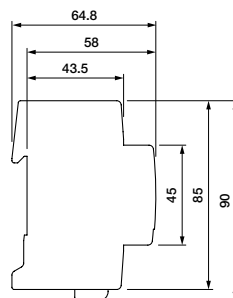

OVR T1 1N 25-255 TS
OVR T1 2L 25-255 TS

Type	Width mm
OVR T1 1N 25-255	71.2
OVR T1 1N 25-255 TS	89
OVR T1 2L 25-255	71.2
OVR T1 2L 25-255 TS	89

OVR Type 1 surge protective devices

TNS - TT - 230 V - 1Ph+N networks

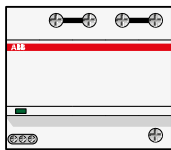

General technical data

	OVR T1 1N 25-255	OVR T1 2L 25-255
Types	OVR T1 1N 25-255	OVR T1 2L 25-255
with auxiliary contact (TS)	OVR T1 1N 25-255 TS	OVR T1 2L 25-255 TS
Technology	Spark-gap	Spark-gap
Electrical features		
Standard	IEC 61643-1 / EN 61643-11	
Type / test class	T1 / I	T1 / I
Protected lines	1+1	2
Types of networks	TNS - TT	TNS
Type of current	AC	AC
Nominal voltage Un	230 V	230 / 400 V
Maximum continuous operating voltage Uc	255 V	255 V
Maximum impulse current Iimp (10/350)	25 kA	25 kA
Maximum impulse current Tot. Iimp (10/350)	50 kA	50 kA
Nominal discharge current In (8/20)	25 kA	25 kA
Follow current interrupting rating Iff	50 kA	50 kA
Voltage protection level Up at In (L-N/N-PE/L-PE)	2.5 / - / 2.5 kV	≤ 2.5 kV
Voltage protection level Up at 3 kA (L-N/N-PE/L-PE)	0.9 / - / 0.9 kV	≤ 0.9 kV
TOV (Temporary overvoltage) withstand Ut (L-N: 5 s / N-PE: 200 ms)	450 / 1200 V	450 V / -
Response time	≤ 100 ns	≤ 100 ns
Residual current IPE	10 µA	10 µA
Short-circuit withstand capability Isccr	50 kA	50 kA
Backup protection	Fuse (gG - gL) ≤ 125 A Circuit breaker (B or C curve) ≤ 125 A	≤ 125 A ≤ 125 A
Pluggable cartridge	No	No
Integrated thermal disconnecter	-	-
State indicator	Yes (TS option)	Yes (TS option)
Safety reserve	No	No
Auxiliary contact (TS)	Yes (TS option)	Yes (TS option)
Installation		
Wire range (L, N, PE)	Solid wire 2.5...50 mm ² Stranded wire 2.5...35 mm ²	2.5...50 mm ² 2.5...35 mm ²
Stripping length (L, N, PE)	15 mm	15 mm
Tightening torque (L, N, PE)	3.5 Nm	3.5 Nm
Auxiliary contact (TS)		
Contact complement	1 NO - 1 NC	1 NO - 1 NC
Minimum load	12 V DC - 10 mA	12 V DC - 10 mA
Maximum load	250 V AC - 1 A	250 V AC - 1 A
Connection cross-section	1.5 mm ²	1.5 mm ²
Miscellaneous characteristics		
Stocking and operating temperature	-40...+80 °C	-40...+80 °C
Degree of protection	IP20	IP20
Fire resistance according to UL 94	V0	V0
Dimensions	mm h x w x d 90 x 71.2 x 64.8 mm inches h x w x d 3.54 x 2.8 x 2.55 in	90 x 71.2 x 64.8 mm 3.54 x 2.8 x 2.55 in
Dimensions with auxiliary contact (TS)	mm h x w x d 90 x 89 x 64.8 mm inches h x w x d 3.54 x 3.5 x 2.55 in	90 x 89 x 64.8 mm 3.54 x 3.5 x 2.55 in

OVR Type 1 surge protective devices

TNS - TT - 230 V - 3Ph+N networks

2



1TXH0001ZF0014

OVR T1 4L 25-255 TS



2CTC431020F1701

OVR T1 3N 25-255-7

Description

Type 1 surge protective devices are designed to discharge high current surges without any destruction of the installation. These surge protective devices are characterized by their capacity to withstand impulse current with 10/350 μ s wave form which simulate natural lightning current.

Type 1 SPDs can be installed at the entrance in the main switch board for a global protection of the electrical installation.

Ordering details

Pro- tected lines	Impulse current limp 10/350 kA	Follow current inter- rupting rating lfi kA	Voltage protec- tion level Up kV	Nominal voltage Un V	Max. cont. operating voltage Uc V	Bbn 3660308 EAN	Type	Order code	Weight Pkg (1 pce) kg
-------------------------	--	---	---	-----------------------------------	--	---------------------------	------	------------	--

Follow current interrupting rating 50 kA - Unpluggable

4	25	50	2.5	230/400	255	510914	OVR T1 4L 25-255	2CTB815101R1400	1.16
4	25	50	2.5	230/400	255	510969	OVR T1 4L 25-255 TS	2CTB815101R0800	1.26
3+1	25	50	2.5	230/400	255	510938	OVR T1 3N 25-255	2CTB815101R1600	1.16
3+1	25	50	2.5	230/400	255	510983	OVR T1 3N 25-255 TS	2CTB815101R0700	1.26

Follow current interrupting rating 7 kA - Unpluggable

3+1	25	7	2	230/400	255	514127	OVR T1 3N 25-255-7	2CTB815101R8800	0.84
-----	----	---	---	---------	-----	--------	--------------------	-----------------	------

Main dimensions mm

Type	Width mm
OVR T1 4L 25-255	142.4
OVR T1 4L 25-255 TS	160.2
OVR T1 3N 25-255	142.4
OVR T1 3N 25-255 TS	160.2
OVR T1 3N 25-255-7	89

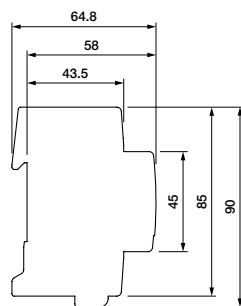

OVR T1 4L 25-255
OVR T1 3N 25-255

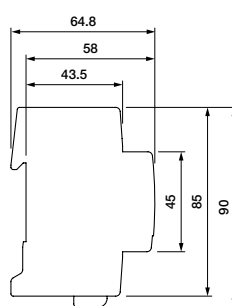

OVR T1 4L 25-255 TS
OVR T1 3N 25-255 TS

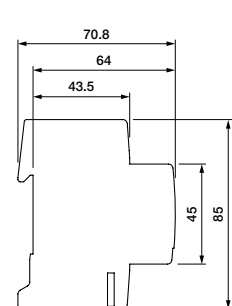

OVR T1 3N 25-255-7

2CTC430004S0201

OVR Type 1 surge protective devices

TNS - TT - 230 V - 3Ph+N networks

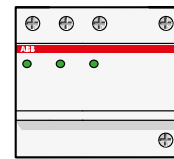
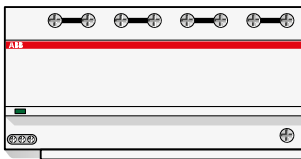

General technical data

	OVR T1 4L 25-255	OVR T1 3N 25-255	OVR T1 3N 25-255-7
Types	OVR T1 4L 25-255	OVR T1 3N 25-255	OVR T1 3N 25-255-7
with auxiliary contact (TS)	OVR T1 4L 25-255 TS	OVR T1 3N 25-255 TS	-
Technology	Spark-gap	Spark-gap	Spark-gap
Electrical features			
Standard	IEC 61643-1 / EN 61643-11		
Type / test class	T1 / I	T1 / I	T1 / I
Protected lines	4	3+1	3+1
Types of networks	TNS	TNS - TT	TNS - TT
Type of current	AC	AC	AC
Nominal voltage Un	230 / 400 V	230 / 400 V	230 / 400 V
Maximum continuous operating voltage Uc	255 V	255 V	255 V
Maximum impulse current Iimp (10/350)	25 kA	25 kA	25 kA
Maximum impulse current Tot. Iimp (10/350)	100 kA	100 kA	100 kA
Nominal discharge current In (8/20)	25 kA	25 kA	25 kA
Follow current interrupting rating Iff	50 kA	50 kA	7 kA
Voltage protection level Up at In (L-N/N-PE/L-PE)	≤ 2.5 kV	2.5 / 2.5 / 2.5 kV	2.0 / 2.0 / 2.0 kV
Voltage protection level Up at 3 kA (L-N/N-PE/L-PE)	≤ 0.9 kV	0.9 / 0.9 / 0.9 kV	0.9 / 0.9 / 0.9 kV
TOV (Temporary overvoltage) withstand Ut (L-N: 5 s / N-PE: 200 ms)	450 V / -	450 / 1200 V	650 / 1200 V
Response time	≤ 100 ns	≤ 100 ns	≤ 100 ns
Residual current IPE	10 µA	10 µA	1000 µA
Short-circuit withstand capability Iscsr	50 kA	50 kA	50 kA
Backup protection	Fuse (gG - gL)	≤ 125 A	≤ 125 A
	Circuit breaker (B or C curve)	≤ 125 A	≤ 125 A
Pluggable cartridge	No	No	No
Integrated thermal disconnecter	-	-	-
State indicator	Yes (TS option)	Yes (TS option)	Yes
Safety reserve	No	No	No
Auxiliary contact (TS)	Yes (TS option)	Yes (TS option)	No
Installation			
Wire range (L, N, PE)	Solid wire	2.5...50 mm ²	2.5...50 mm ²
	Stranded wire	2.5...35 mm ²	2.5...35 mm ²
Stripping length (L, N, PE)	15 mm	15 mm	15 mm
Tightening torque (L, N, PE)	3.5 Nm	3.5 Nm	3.5 Nm
Auxiliary contact (TS)			
Contact complement	1 NO - 1 NC	1 NO - 1 NC	-
Minimum load	12 V DC - 10 mA	12 V DC - 10 mA	-
Maximum load	250 V AC - 1 A	250 V AC - 1 A	-
Connection cross-section	1.5 mm ²	1.5 mm ²	-
Miscellaneous characteristics			
Stocking and operating temperature	-40...+80 °C	-40...+80 °C	-40...+80 °C
Degree of protection	IP20	IP20	IP20
Fire resistance according to UL 94	V0	V0	V0
Dimensions	mm	h x w x d 90 x 142.4 x 64.8 mm	85 x 89 x 70.8 mm
	inches	h x w x d 3.54 x 5.61 x 2.55 in	3.35 x 3.5 x 2.79 in
Dimensions with auxiliary contact (TS)	mm	h x w x d 90 x 160.2 x 64.8 mm	-
	inches	h x w x d 3.54 x 6.31 x 2.55 in	-

OVR Type 1 surge protective devices - Single pole neutral

2



OVR T1 100 N

Description

Type 1 surge protective devices are designed to discharge high current surges without any destruction of the installation. These surge protective devices are characterized by their capacity to withstand impulse current with 10/350 μ s wave form which simulate natural lightning current.

Type 1 SPDs can be installed at the entrance in the main switch board for a global protection of the electrical installation.

Ordering details

Protected lines	Impulse current limp 10/350 kA	Follow current interrupting rating I _{fi} kA	Voltage protection level U _p kV	Nominal voltage U _n V	Max. cont. operating voltage U _c V	Bbn 3660308 EAN	Type	Order code	Weight Pkg (1 pce) kg
-----------------	---	---	--	--	---	-----------------------	------	------------	--------------------------------

Type 1 Neutral - Unpluggable

1	25	0.1	4	440	690	517043	OVR T1 25 N	2CTB815101R9700	0.15
1	50	0.1	1.5	230	255	510853	OVR T1 50 N	2CTB815101R0400	0.29
1	100	0.1	2	230	255	510860	OVR T1 100 N	2CTB815101R0500	0.29

Main dimensions mm

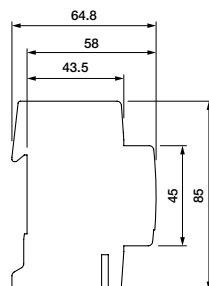

OVR T1 25 N
OVR T1 50 N
OVR T1 100 N

Type	Width mm
OVR T1 25 N	17.8
OVR T1 50 N	35.6
OVR T1 100 N	35.6

2CTC430005S0201

OVR Type 1 surge protective devices - Single pole neutral

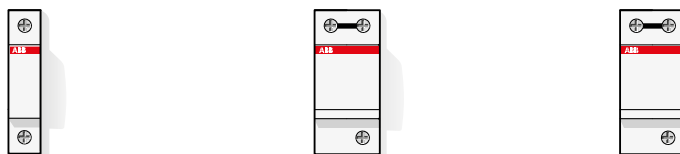

General technical data

	OVR T1 25 N	OVR T1 50 N	OVR T1 100 N
Types with auxiliary contact (TS)	–	–	–
Technology	Gas discharge tube (GDT)	Gas discharge tube (GDT)	Gas discharge tube (GDT)
Electrical features			
Standard	IEC 61643-1 / EN 61643-11		
Type / test class	T1 / I	T1 / I	T1 / I
Protected lines	1	1	1
Types of networks	Neutral	Neutral	Neutral
Type of current	AC	AC	AC
Nominal voltage U_n	440 V	230 V	230 V
Maximum continuous operating voltage U_c	690 V	255 V	255 V
Maximum impulse current I_{imp} (10/350)	25 kA	50 kA	100 kA
Maximum impulse current Tot. I_{imp} (10/350)	25 kA	50 kA	100 kA
Nominal discharge current I_n (8/20)	25 kA	25 kA	25 kA
Follow current interrupting rating I_{fi}	0.1 kA	0.1 kA	0.1 kA
Voltage protection level U_p at I_n	≤ 4 kV	≤ 1.5 kV	≤ 2 kV
Voltage protection level U_p at 3 kA	–	0.9 kV	0.9 kV
TOV (Temporary overvoltage) withstand U_t (L-N: 5 s / N-PE: 200 ms)	– / 1200 V	– / 1200 V	– / 1200 V
Response time	≤ 100 ns	≤ 100 ns	≤ 100 ns
Residual current IPE	10 μ A	10 μ A	10 μ A
Short-circuit withstand capability I_{scsr}	50 kA	50 kA	50 kA
Backup protection	Fuse (gG - gL) Circuit breaker (B or C curve)	–	–
Pluggable cartridge	No	No	No
Integrated thermal disconnect	–	–	–
State indicator	No	No	No
Safety reserve	No	No	No
Auxiliary contact (TS)	No	No	No
Installation			
Wire range (L, N, PE)	Solid wire Stranded wire	2.5...50 mm ² 2.5...35 mm ²	2.5...50 mm ² 2.5...35 mm ²
Stripping length (L, N, PE)	15 mm	15 mm	15 mm
Tightening torque (L, N, PE)	3.5 Nm	3.5 Nm	3.5 Nm
Auxiliary contact (TS)			
Contact complement	–	–	–
Minimum load	–	–	–
Maximum load	–	–	–
Connection cross-section	–	–	–
Miscellaneous characteristics			
Stocking and operating temperature	–40...+80 °C	–40...+80 °C	–40...+80 °C
Degree of protection	IP20	IP20	IP20
Fire resistance according to UL 94	V0	V0	V0
Dimensions	mm <i>h x w x d</i>	85 x 17.8 x 64.8 mm 3.35 x 0.7 x 2.55 in	85 x 35.6 x 64.8 mm 3.35 x 1.4 x 2.55 in
Dimensions with auxiliary contact (TS)	mm <i>h x w x d</i>	–	–

OVR Type 1+2 surge protective devices - Single pole

2



2CTC431042V0014

OVR T1-T2 12.5-275s P QS



2CTC431050V0014

OVR T1-T2 12.5-440s P QS



2CTC431021F1701

OVR T1+2 15-255-7

Description

Type 1 and Type 1+2 surge protective devices are designed to discharge high current surges without any destruction of the installation. These surge protective devices are characterized by their capacity to withstand impulse current with 10/350 μ s wave form which simulate natural lightning current.

Type 1+2 ABB surge protective devices have a high impulse current withstand capacity with ensuring a low protection level (U_p).

Type 1 and Type 1+2 SPDs can be installed at the entrance in the main switch board for a global protection of the electrical installation.

Ordering details

Protect- ed lines	Impulse current limp 10/350 kA	Max. dis- charge current Imax 8/20 kA	Follow current inter- rupting rating I _{fi} kA	Voltage protec- tion level Up kV	Nominal voltage Un V	Max. cont. operating voltage Uc V	Bbn 3660308 EAN	Type	Order code	Weight Pkg (1 pce) kg
-------------------	---	--	---	--	----------------------------	---	-----------------------	------	------------	--------------------------------

Pluggable

1	12.5	80	-	1.1	230	275	524959	OVR T1-T2 12.5-275s P QS*	2CTB815710R1200	0.15
1	12.5	80	-	1.1	230	275	524881	OVR T1-T2 12.5-275s P TS QS*	2CTB815710R0000	0.15
1	12.5	80	-	1.6	400	440	525123	OVR T1-T2 12.5-440s P QS*	2CTB815710R4100	0.3
1	12.5	80	-	1.6	400	440	525055	OVR T1-T2 12.5-440s P TS QS*	2CTB815710R2900	0.3
1	50	80	-	1	230	275	525024	OVR T1-T2 N 50-275s P QS*	2CTB815710R2400	0.15
1	50	80	-	1	400	440	525192	OVR T1-T2 N 50-440s P QS*	2CTB815710R5300	0.14

Unpluggable

1	15	60	7	1.7	230	255	514134	OVR T1+2 15-255-7	2CTB815101R8900	0.14
1	25	60	15	1.5	230	255	510884	OVR T1+2 25-255 TS	2CTB815101R0300	0.27

* Products available end 2015.

Main dimensions mm

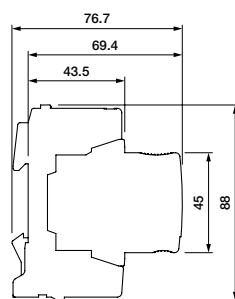

OVR T1-T2 12.5-275s P QS
OVR T1-T2 12.5-440s P QS
OVR T1-T2 N 50-275s P QS
OVR T1-T2 N 50-440s P QS

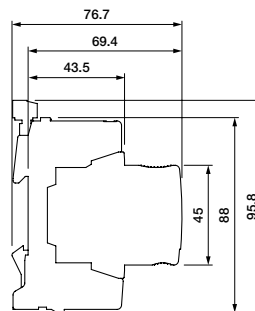

OVR T1-T2 12.5-275s P TS QS
OVR T1-T2 12.5-440s P TS QS

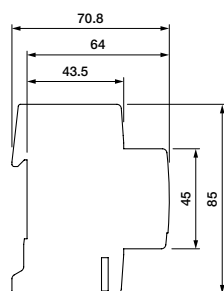

OVR T1+2 15-255-7

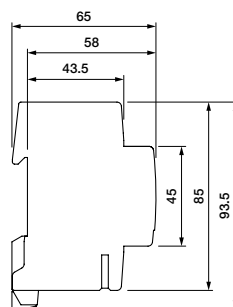

OVR T1+2 25-255 TS

Type	Width mm
OVR T1-T2 12.5-275s P TS QS	17.8
OVR T1-T2 12.5-275s P QS	17.8
OVR T1-T2 12.5-440s P TS QS	35.6
OVR T1-T2 12.5-440s P QS	35.6
OVR T1-T2 N 50-275s P QS	17.8
OVR T1-T2 N 50-440 P QS	17.8
OVR T+2 25-255 TS	35.6
OVR T+2 15-255-7	17.8

OVR Type 1+2 surge protective devices - Single pole

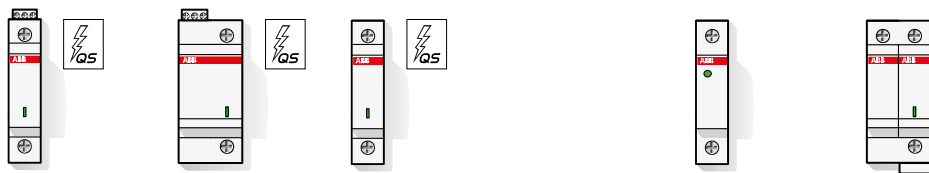

General technical data

Types	OVR T1-T2 12.5-275s P QS	OVR T1-T2 12.5-440s P QS	OVR T1-T2 N 50-275s P QS	OVR T1-T2 N 50-440s P QS	OVR T1+2 15-255-7	-	
with auxiliary contact (TS)	OVR T1-T2 12.5-275s P TS QS	OVR T1-T2 12.5-440s P TS QS	-	-	-	OVR T1+2 25-255 TS	
Electrical features							
Standard	IEC 61643-11 / EN 61643-11						
Type / test class	T1-T2/I - II	T1-T2/I - II	T1-T2/I - II	T1-T2/I - II	T1+2/I - II	T1+2/I - II	
Protected lines	1	1	N	N	1	1	
System network	TNC - TNS - TT (L-N)	TNC - TNS - TT (L-N)	TNS (N) - TT (N)	TNS (N) - TT (N)	TNC - TNS - TT (L-N)	TNC - TNS - TT (L-N)	
Type of current	AC 45-65 Hz	AC 45-65 Hz	AC 45-65 Hz	AC 45-65 Hz	AC 45-65 Hz	AC 45-65 Hz	
Nominal system voltage Un	230 V	400 V	230 V	400 V	230 V	230 V	
Max. cont. operating voltage Uc	275 V	440 V	275 V	440 V	255 V	255 V	
Nominal DC voltage Udc L-PE	320 V DC	495 V DC	-	-	-	-	
Max. DC cont. operating voltage Udc L-PE	355 V DC	545 V DC	-	-	-	-	
Maximum impulse current Iimp (10/350)	12.5 kA	12.5 kA	50 kA	50 kA	15 kA	25 kA	
Nominal discharge current In (8/20)	30 kA	30 kA	30 kA	30 kA	15 kA	25 kA	
Maximal discharge current Imax (8/20)	80 kA	80 kA	80 kA	80 kA	60 kA	60 kA	
Follow current interrupting rating I _{fi}	-	-	-	-	7 kA	15 kA	
Voltage protection level Up at In	1.1 kV	1.6 kV	1 kV	1 kV	1.7 kV	1.5 kV	
Voltage protection level Up at 3 kA	-	-	-	-	0.9 kV	1.0 kV	
TOV (Temporary overvoltage) withstand Ut (L-N: 5 s./N-PE: 200 ms)	337 V / -	581 V / -	- / 1200 V	- / 1200 V	650 V / -	334 V / -	
Response time	< 25 ns	< 25 ns	≤10 ns	≤10 ns	< 100 ns	< 100 ns	
Short-circuit withstand capability I _{sc}	100 kA	100 kA	≤100 kA	≤100 kA	≤50 kA	≤50 kA	
Backup protection fuse (gG - gL) maximum rating	≤ 160 A	≤ 160 A	-	-	≤125 A	≤125 A	
Backup protection circuit breaker (B or C curve)	≤ 125 A	≤ 125 A	-	-	≤125 A	≤125 A	
Pluggable cartridge	Yes	Yes	Yes	Yes	No	No	
Integrated thermal disconnect	Yes	Yes	No	No	No	Yes	
State indicator	Yes	Yes	No	No	No	Yes	
Safety reserve	Yes	Yes	No	No	No	No	
Auxiliary contact (TS)	Yes (TS option)	Yes (TS option)	No	No	No	Yes	
Installation							
Wire range (L, N, PE) solid wire	2.5...35 mm ²	2.5...35 mm ²	2.5...50 mm ²	2.5...50 mm ²	2.5...50 mm ²	2.5...50 mm ²	
stranded wire	2.5...25 mm ²	2.5...25 mm ²	2.5...35 mm ²	2.5...35 mm ²	2.5...35 mm ²	2.5...35 mm ²	
Stripping length (L, N, PE)	12.5 mm	12.5 mm	12.5 mm	12.5 mm	15 mm	15 mm	
Tightening torque (L, N, PE)	2.8 Nm	2.8 Nm	3.5 Nm	3.5 Nm	3.5 Nm	3.5 Nm	
Auxiliary contact (TS)							
Contacts information	1 NO - 1 NC	1 NO - 1 NC	-	-	-	1 NO - 1 NC	
Min. load	12 V DC - 10 mA	12 V DC - 10 mA	-	-	-	12 V DC - 10 mA	
Max. load	250 V AC - 1 A	250 V AC - 1 A	-	-	-	250 V AC - 1 A	
Connection cross-section	6.5 mm ²	6.5 mm ²	-	-	-	1.5 mm ²	
Miscellaneous characteristics							
Stocking and operating temperature	-40...+80 °C	-40...+80 °C	-40...+80 °C	-40...+80 °C	-40...+80 °C	-40...+80 °C	
Degree of protection	IP20	IP20	IP20	IP20	IP20	IP20	
Fire resistance according to UL 94	V0	V0	V0	V0	V0	V0	
Dimensions	mm h x w x d 88 x 17.8 x 76.7 mm 3.46 x 0.7 x 3.02 in	mm h x w x d 88 x 35.6 x 76.7 mm 3.46 x 1.4 x 3.02 in	mm h x w x d 88 x 17.8 x 76.7 mm 3.46 x 0.7 x 3.02 in	mm h x w x d 88 x 17.8 x 76.7 mm 3.46 x 0.7 x 3.02 in	mm h x w x d 85 x 17.8 x 70.8 mm 3.35 x 0.7 x 2.79 in	-	-
Dimensions with auxiliary contact (TS)	mm h x w x d 95.8 x 17.8 x 76.7 mm 3.77 x 0.7 x 3.02 in	mm h x w x d 95.8 x 35.6 x 76.7 mm 3.77 x 1.4 x 3.02 in	-	-	-	mm h x w x d 93.5 x 35.6 x 65 mm 3.68 x 1.4 x 2.56 in	
Replacement cartridges							
Phase product ID	Type	Type	Type	Type	-	-	
Order code	OVR T1-T2 12.5-275s C QS	OVR T1-T2 12.5-440s C QS	OVR T1-T2 N 50-275s C QS	OVR T1-T2 N 50-440s C QS	-	-	
Neutral product ID	Type	Type	Type	Type	OVR T1 25 N	OVR T1 50 N	
Order code	2CTB815710R2600	2CTB815710R5500	2CTB815710R2700	2CTB815710R5600	2CTB815101R9700	2CTB815101R0400	

OVR Type 1+2 surge protective devices

TNC - 230 and 400 V networks

2

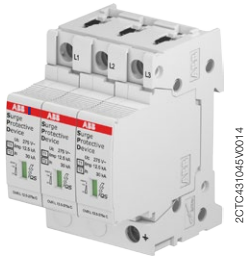

2CTC431045V0014

OVR T1-T2 3L 12.5-275s P QS



2CTC431060V0014

OVR T1-T2 3L 12.5-440s P QS

Description

Type 1 and Type 1+2 surge protective devices are designed to discharge high current surges without any destruction of the installation. These surge protective devices are characterized by their capacity to withstand impulse current with 10/350 μ s wave form which simulate natural lightning current.

Type 1+2 ABB surge protective devices have a high impulse current withstand capacity with ensuring a low protection level (U_p).

Type 1 and Type 1+2 SPDs can be installed at the entrance in the main switch board for a global protection of the electrical installation.

Ordering details

Pro- tect- ed lines	Impulse current limp 10/350 kA	Max. dis- charge current Imax 8/20 kA	Voltage protec- tion level U_p kV	Nominal voltage U_n V	Max. cont. operating voltage U_c V	Bbn 3660308 EAN	Type	Order code	Weight Pkg (1 pce) kg
------------------------------	--	---	--	----------------------------------	---	---------------------------	------	------------	--

Follow current interrupting rating 50 kA - Pluggable

3	12.5	80	1.1	230/400	275	524980	OVR T1-T2 3L 12.5-275s P QS*	2CTB815710R1800	0.45
3	12.5	80	1.1	230/400	275	524911	OVR T1-T2 3L 12.5-275s P TS QS*	2CTB815710R0600	0.45
3	12.5	80	1.8	400/690	440	525154	OVR T1-T2 3L 12.5-440s P QS*	2CTB815710R4700	0.9
3	12.5	80	1.8	400/690	440	525086	OVR T1-T2 3L 12.5-440s P TS QS*	2CTB815710R3500	0.9

Follow current interrupting rating 50 kA - Unpluggable

3	25	60	1.5	230/400	255	513397	OVR T1+2 3L 25-255 TS	2CTB815101R4300	0.85
---	----	----	-----	---------	-----	--------	-----------------------	-----------------	------

* Products available end 2015.

Main dimensions mm

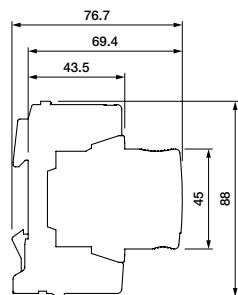

OVR T1-T2 3L 12.5-275s P QS
OVR T1-T2 3L 12.5-440s P QS

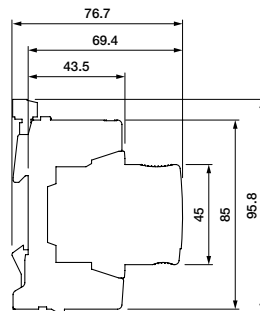

OVR T1-T2 3L 12.5-275s P TS QS

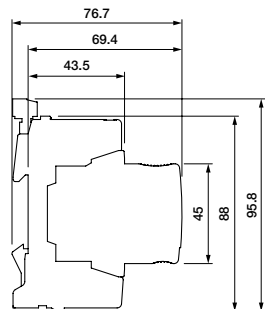

OVR T1-T2 3L 12.5-440s P TS QS

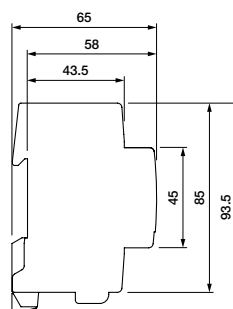

OVR T1+2 3L 25-255 TS

Type	Width mm
OVR T1-T2 3L 12.5-275s P TS QS	53.4
OVR T1-T2 3L 12.5-275s P QS	53.4
OVR T1-T2 3L 12.5-440s P TS QS	106.8
OVR T1-T2 3L 12.5-440s P QS	106.8
OVR T1+2 3L 25-255 TS	106.8

2CTC431002S0201

OVR Type 1+2 surge protective devices

TNC - 230 and 400 V networks

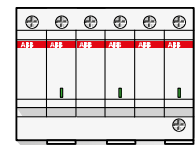
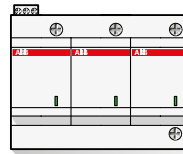

General technical data

Types	OVR T1-T2 3L 12.5-275s P QS	OVR T1-T2 3L 12.5-440s P QS	-
with auxiliary contact (TS)	OVR T1-T2 3L 12.5-275s P TS QS	OVR T1-T2 3L 12.5-440s P TS QS	OVR T1+2 3L 25-255 TS
Electrical features			
Standard	IEC 61643-11 / EN 61643-11		
Type / test class	T1-T2/I - II	T1-T2/I - II	T1+2/I - II
Protected lines	3	3	3
System network	TNC - TNS - TT (L-N)	TNC - TNS - TT (L-N)	TNC - TNS - TT (L-N)
Type of current	AC 45-65 Hz	AC 45-65 Hz	AC 45-65 Hz
Nominal system voltage Un	230 / 400 V	400 / 690 V	230 / 400 V
Max. cont. operating voltage Uc	275 V	440 V	255 V
Nominal DC voltage Undc L-PE / Undc L-L	320 / 640 V DC	495 / 990 V DC	-
Max. DC cont. operating voltage Ucdc L-PE	355 / 710 V DC	545 / 1090 V DC	-
Maximum impulse current Iimp (10/350)	12.5 kA	12.5 kA	25 kA
Max. Imp current Tot Iimp (10/350)	37.5 kA	37.5 kA	75 kA
Nominal discharge current In (8/20)	30 kA	30 kA	25 kA
Maximum discharge current Imax (8/20)	80 kA	80 kA	60 kA
Follow current interrupting rating I _{fi}	-	-	-
Voltage protection level Up at In	1.1 kV	1.8 kV	1.5 kV
Voltage protection level Up at 3 kA	0.5 kV	0.8 kV	1.0 kV
TOV (Temporary overvoltage) withstand Ut (L-N: 5 s./N-PE: 200 ms)	337 V / -	581 V / -	334 V / -
Response time	25 ns	25 ns	< 100 ns
Short-circuit withstand capability I _{scrr}	100 kA	100 kA	≤ 50 kA
Backup protection fuse (gG - gL)	≤ 160 A	≤ 160 A	≤ 125 A
maximum rating circuit breaker (B or C)	≤ 125 A	≤ 125 A	≤ 125 A
Pluggable cartridge	Yes	Yes	No
Integrated thermal disconnecter	Yes	Yes	Yes
State indicator	Yes	Yes	Yes
Safety reserve	Yes	Yes	No
Auxiliary contact (TS)	Yes (TS option)	Yes (TS option)	Yes
Installation			
Wire range (L, N, PE) solid wire	2.5...35 mm ²	2.5...35 mm ²	2.5...50 mm ²
stranded wire	2.5...25 mm ²	2.5...25 mm ²	2.5...35 mm ²
Stripping length (L, N, PE)	12.5 mm	12.5 mm	15 mm
Tightening torque (L, N, PE)	2.8 Nm	2.8 Nm	3.5 Nm
Auxiliary contact (TS)			
Contacts information	6 NO - 1 NC	6 NO - 1 NC	1 NO - 1 NC
Min. load	12 DC - 10 mA	12 DC - 10 mA	12 V DC - 10 mA
Max. load	250 V AC - 1 A	250 V AC - 1 A	250 V AC - 1 A
Connection cross-section	1.5 mm ²	1.5 mm ²	1.5 mm ²
Miscellaneous characteristics			
Stocking and operating temperature	-40...+80 °C	-40...+80 °C	-40...+80 °C
Degree of protection	IP20	IP20	IP20
Fire resistance according to UL 94	V0	V0	V0
Dimensions mm	h x w x d 88 x 53.4 x 76.7 mm	h x w x d 88 x 106.8 x 76.7 mm	-
inches	h x w x d 3.46 x 2.1 x 3.02 in	h x w x d 3.46 x 4.2 x 3.02 in	-
Dimensions with auxiliary contact (TS) mm	h x w x d 95.8 x 53.4 x 76.7 mm	h x w x d 95.8 x 106.8 x 76.7 mm	93.5 x 106.8 x 65 mm
inches	h x w x d 3.77 x 2.1 x 3.02 in	h x w x d 3.77 x 4.2 x 3.02 in	3.68 x 4.2 x 2.56 in
Replacement cartridges			
Phase product ID	OVR T1-T2 12.5-275s C QS	OVR T1-T2 12.5-440s C QS	OVR T1+2 25-255 C
Order code	2CTB815710R2600	2CTB815710R5500	2CTB815101R3700

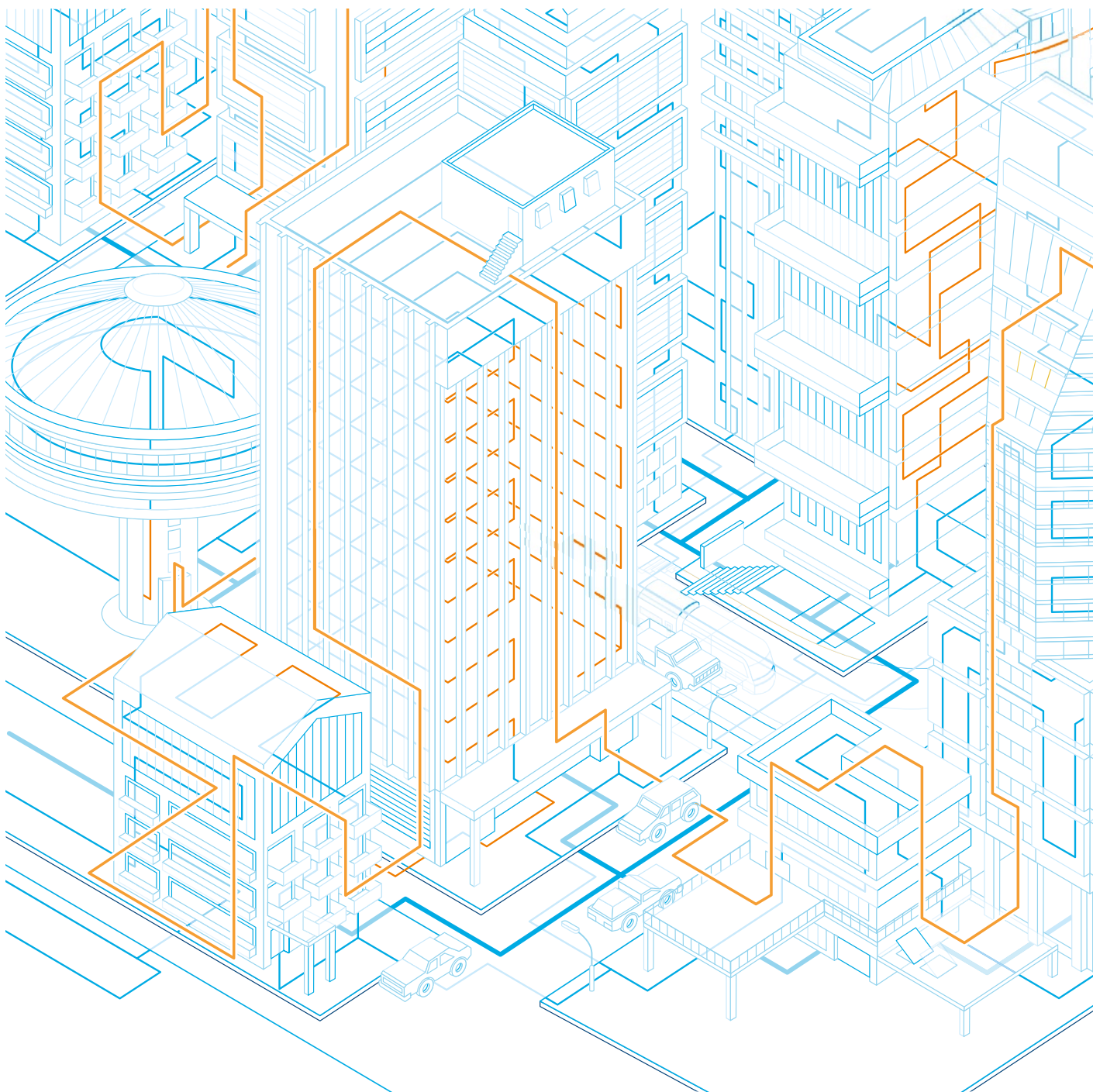

2CTC43100350201

OVR Type 1+2 surge protective devices

TNS - TT - 230 and 400 V - 1Ph+N and 3Ph+N networks

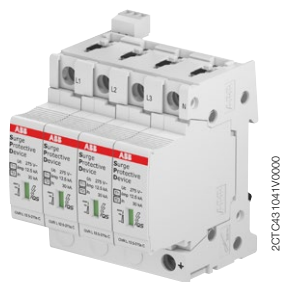

OVR T1-T2 3N 12.5-440s P TS

Description

Type 1 and Type 1+2 surge protective devices are designed to discharge high current surges without any destruction of the installation. These surge protective devices are characterized by their capacity to withstand impulse current with 10/350 μ s wave form which simulate natural lightning current.

Type 1+2 ABB surge protective devices have a high impulse current withstand capacity with ensuring a low protection level (Up).

Type 1 and Type 1+2 SPDs can be installed at the entrance in the main switch board for a global protection of the electrical installation.

Ordering details

Protected lines	Impulse current Iimp 10/350 kA	Max. discharge current Imax 8/20 kA	Follow current interrupting rating Ifi kA	Voltage protection level Up kV	Nominal voltage Un V	Max. cont. operating voltage Uc V	Bbn 3660308 EAN	Type	Order code	Weight Pkg (1 pce) kg
-----------------	---	--	---	--------------------------------------	----------------------------	---	-----------------------	------	------------	--------------------------------

Pluggable

1+1	12.5	80	-	1.3	230	275	524966	OVR T1-T2 1N 12.5-275s P QS*	2CTB815710R1300	0.3
1+1	12.5	80	-	1.3	230	275	524898	OVR T1-T2 1N 12.5-275s P TS QS*	2CTB815710R0100	0.3
1+1	12.5	80	-	1.8	400	440	525130	OVR T1-T2 1N 12.5-440s P QS*	2CTB815710R4200	0.45
1+1	12.5	80	-	1.8	400	440	525062	OVR T1-T2 1N 12.5-440s P TS QS*	2CTB815710R3000	0.45
3+1	12.5	80	-	1.3	230/400	275	524997	OVR T1-T2 3N 12.5-275s P QS*	2CTB815710R1900	0.6
3+1	12.5	80	-	1.3	230/400	275	524928	OVR T1-T2 3N 12.5-275s P TS QS*	2CTB815710R0700	0.6
3+1	12.5	80	-	1.8	400/690	440	525161	OVR T1-T2 3N 12.5-440s P QS*	2CTB815710R4800	1.05
3+1	12.5	80	-	1.8	400/690	440	525093	OVR T1-T2 3N 12.5-440s P TS QS*	2CTB815710R3600	1.05
4	12.5	80	-	1.1	230/400	275	525017	OVR T1-T2 4L 12.5-275s P QS*	2CTB815710R2300	0.6
4	12.5	80	-	1.1	230/400	275	524942	OVR T1-T2 4L 12.5-275s P TS QS*	2CTB815710R1100	0.6
4	12.5	80	-	1.8	400/690	440	525185	OVR T1-T2 4L 12.5-440s P QS*	2CTB815710R5200	1.2
4	12.5	80	-	1.8	400/690	440	525116	OVR T1-T2 4L 12.5-440s P TS QS*	2CTB815710R4000	1.2

Unpluggable

3+1	15	60	7	1.5	230/400	255	514141	OVR T1+2 3N 15-255-7	2CTB815101R9000	0.84
1+1	25	60	15	1.5	230	255	513519	OVR T1+2 1N 25-255 TS	2CTB815101R4400	0.54
3+1	25	60	15	1.5	230/400	255	513526	OVR T1+2 3N 25-255 TS	2CTB815101R4500	1.07
4	25	60	15	1.5	230/400	255	513435	OVR T1+2 4L 25-255 TS	2CTB815101R4200	1.07

* Products available end 2015.

Main dimensions mm

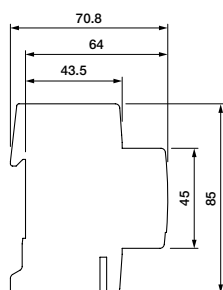

OVR T1+2 3N 15-255-7

Type	Width mm
OVR T1-T2 1N 12.5-275s P QS	35.6
OVR T1-T2 1N 12.5-275s P TS QS	35.6
OVR T1-T2 1N 12.5-440s P QS	53.4
OVR T1-T2 1N 12.5-440s P TS QS	53.4
OVR T1-T2 3N 12.5-275s P QS	71.2
OVR T1-T2 3N 12.5-275s P TS QS	71.2
OVR T1-T2 3N 12.5-440s P QS	124.6
OVR T1-T2 3N 12.5-440s P TS QS	124.6
OVR T1-T2 4L 12.5-275s P QS	71.2
OVR T1-T2 4L 12.5-275s P TS QS	71.2
OVR T1-T2 4L 12.5-440s P QS	142.4
OVR T1-T2 4L 12.5-440s P TS QS	142.4
OVR T1+2 3N 15-255-7	89
OVR T1+2 1N 25-255 TS	71.2
OVR T1+2 3N 25-255 TS	142.4
OVR T1+2 4L 25-255 TS	142.4

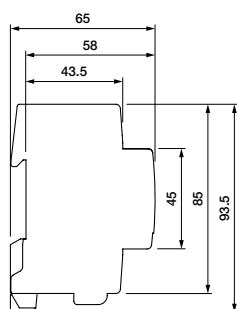

OVR T1+2 1N 25-255 TS
OVR T1+2 3N 25-255 TS
OVR T1+2 4L 25-255 TS

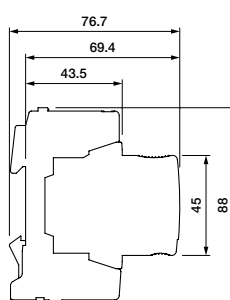

OVR T1-T2 1N 12.5-275s P QS
OVR T1-T2 1N 12.5-440s P QS
OVR T1-T2 3N 12.5-275s P QS
OVR T1-T2 3N 12.5-440s P QS
OVR T1-T2 4L 12.5-275s P QS
OVR T1-T2 4L 12.5-440s P QS

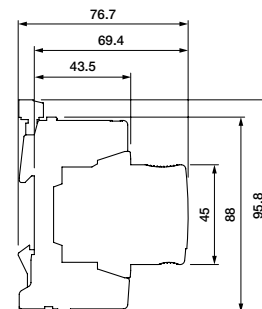

OVR T1-T2 1N 12.5-275s P TS QS
OVR T1-T2 1N 12.5-440s P TS QS
OVR T1-T2 3N 12.5-275s P TS QS
OVR T1-T2 3N 12.5-440s P TS QS
OVR T1-T2 4L 12.5-275s P TS QS
OVR T1-T2 4L 12.5-440s P TS QS

OVR Type 1+2 surge protective devices

TNS - TT - 230 and 400 V - 1Ph+N and 3Ph+N networks

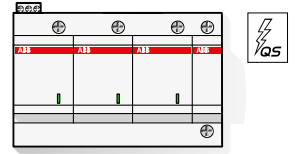
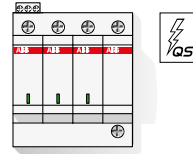
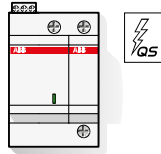
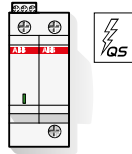

2

General technical data

Types	OVR T1-T2 1N 12.5-275s P QS	OVR T1-T2 1N 12.5-440s P QS	OVR T1-T2 3N 12.5-275s P QS	OVR T1-T2 3N 12.5-440s P QS
with auxiliary contact (TS)	OVR T1-T2 1N 12.5-275s P TS QS	OVR T1-T2 1N 12.5-440s P TS QS	OVR T1-T2 3N 12.5-275s P TS QS	OVR T1-T2 3N 12.5-440s P TS QS
Electrical features				
Standard	IEC 61643-11 / EN 61643-11			
Type / test class	T1-T2/I - II	T1-T2/I - II	T1-T2/I - II	T1-T2/I - II
Protected lines	1+1	1+1	3+1	3+1
System network	TNS - TT (L-N)	TNS - TT (L-N)	TNS - TT (L-N)	TNS - TT (L-N)
Type of current	AC 45-65 Hz	AC 45-65 Hz	AC 45-65 Hz	AC 45-65 Hz
Nominal system voltage Un	230 V	400 V	230 / 400 V	400 / 690 V
Max. cont. operating voltage Uc	275 V	440 V	275 V	440 V
Nominal DC voltage	-	-	-	-
Undc L-PE / Undc L-L	-	-	-	-
Max. DC cont. operating voltage	-	-	-	-
Ucdc L-PE / Ucdc L-L	-	-	-	-
Maximum impulse current Iimp (10/350)	12.5 kA	12.5 kA	12.5 kA	12.5 kA
Max. Imp current Tot Iimp (10/350)	25 kA	25 kA	50 kA	50 kA
Nominal discharge current In (8/20)	30 kA	30 kA	30 kA	30 kA
Maximum discharge current I _{max} (8/20)	80 kA	80 kA	80 kA	80 kA
Follow current interrupting rating I _{fi}	-	-	-	-
Voltage protection level Up at I _n	1.3 kV	1.8 kV	1.3 kV	1.8 kV
Voltage protection level Up at 3 kA	0.5 kV	0.8 kV	0.5 kV	0.8 kV
TOV (Temporary overvoltage) withstand Ut (L-N: 5 s./N-PE: 200 ms)	337 / 1200 V	581 / 1200 V	337 / 1200 V	581 / 1200 V
Response time	25 ns	25 ns	25 ns	25 ns
Short-circuit withstand capability I _{sc}	100 kA	100 kA	100 kA	100 kA
Backup protection fuse (gG - gL) maximum rating	≤ 160 A	≤ 160 A	≤ 160 A	≤ 160 A
circuit breaker (B or C curve)	≤ 125 A	≤ 125 A	≤ 125 A	≤ 125 A
Pluggable cartridge	Yes	Yes	Yes	Yes
Integrated thermal disconnect	Yes	Yes	Yes	Yes
State indicator	Yes	Yes	Yes	Yes
Safety reserve	Yes	Yes	Yes	Yes
Auxiliary contact (TS)	Yes (TS option)	Yes (TS option)	Yes (TS option)	Yes (TS option)
Installation				
Wire range (L, N, PE) solid wire	2.5...35 mm ²	2.5...35 mm ²	2.5...35 mm ²	2.5...35 mm ²
stranded wire	2.5...25 mm ²	2.5...25 mm ²	2.5...25 mm ²	2.5...25 mm ²
Stripping length (L, N, PE)	12.5 mm	12.5 mm	12.5 mm	12.5 mm
Tightening torque (L, N, PE)	2.8 Nm	2.8 Nm	2.8 Nm	2.8 Nm
Auxiliary contact (TS)				
Contacts information	1 NO - 1 NC	1 NO - 1 NC	1 NO - 1 NC	1 NO - 1 NC
Min. load	12 DC - 10 mA	12 DC - 10 mA	12 DC - 10 mA	12 DC - 10 mA
Max. load	250 V AC - 1 A	250 V AC - 1 A	250 V AC - 1 A	250 V AC - 1 A
Connection cross-section	1.5 mm ²	1.5 mm ²	1.5 mm ²	1.5 mm ²
Miscellaneous characteristics				
Stocking and operating temperature	-40...+80 °C	-40...+80 °C	-40...+80 °C	-40...+80 °C
Degree of protection	IP20	IP20	IP20	IP20
Fire resistance according to UL 94	V0	V0	V0	V0
Dimensions	mm h x w x d 88 x 35.6 x 76.7 mm	mm h x w x d 88 x 53.4 x 76.7 mm	mm h x w x d 88 x 71.2 x 76.7 mm	mm h x w x d 88 x 124.6 x 76.7 mm
	inches h x w x d 3.46 x 1.4 x 3.02 in	inches h x w x d 3.46 x 2.1 x 3.02 in	inches h x w x d 3.46 x 2.8 x 3.02 in	inches h x w x d 3.46 x 4.91 x 3.02 in
Dimensions with auxiliary contact (TS)	mm h x w x d 95.8 x 35.6 x 76.7 mm	mm h x w x d 95.8 x 53.4 x 76.7 mm	mm h x w x d 95.8 x 71.2 x 76.7 mm	mm h x w x d 95.8 x 124.6 x 76.7 mm
	inches h x w x d 3.46 x 1.4 x 3.02 in	inches h x w x d 3.77 x 2.1 x 3.02 in	inches h x w x d 3.77 x 2.8 x 3.02 in	inches h x w x d 3.77 x 4.91 x 3.02 in
Replacement cartridges				
Phase product ID	Type	OVR T1-T2 12.5-275s C QS	OVR T1-T2 12.5-440s C QS	OVR T1-T2 12.5-275s C QS
	Order code	2CTB815710R2600	2CTB815710R5500	2CTB815710R2600
				OVR T1-T2 12.5-440s C QS 2CTB815710R5500

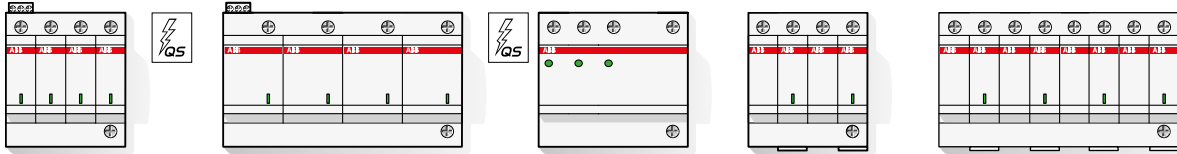

OVR T1-T2 4L 12.5-275s P QS OVR T1-T2 4L 12.5-275s P TS QS	OVR T1-T2 4L 12.5-440s P QS OVR T1-T2 4L 12.5-440s P TS QS	OVR T1+2 3N 15-255-7 -	- OVR T1+2 1N 25-255 TS	- OVR T1+2 3N 25-255 TS	- OVR T1+2 4L 25-255 TS
T1-T2/I - II 4 TNS AC 45-65 Hz 230 / 400 V 275 V 320 / 640 V DC 355 / 710 V DC 12.5 kA 50 kA 30 kA 80 kA - 1.1 kV 0.5 kV 337 V / - 25 ns 100 kA ≤ 160 A ≤ 125 A Yes Yes Yes Yes Yes (TS option)	T1-T2/I - II 4 TNS AC 45-65 Hz 400 / 690 V 440 V 495 / 990 V DC 545 / 1090 V DC 12.5 kA 50 kA 30 kA 80 kA - 1.8 kV 0.8 kV 581 V / - 25 ns 100 kA ≤ 160 A ≤ 125 A Yes Yes Yes Yes Yes (TS option)	T1-T2/I - II 3+1 TNS - TT AC 45-65 Hz 230 / 400 V 255 V - - 15 kA 60 kA 15 kA 60 kA 7 kA 1.5 kV 0.9 kV 650 / 1200 V < 100 ns ≤ 50 kA ≤ 125 A ≤ 125 A No No Yes No No	T1-T2/I - II 1+1 TNC - TNS - TT (L-N) AC 45-65 Hz 230 V 255 V - - 25 kA 50 kA 25 kA 60 kA 15 kA 1.5 kV 1.0 kV 334 V / - < 100 ns ≤ 50 kA ≤ 125 A ≤ 125 A No Yes Yes No Yes	T1-T2/I - II 3+1 TNC - TNS - TT (L-N) AC 45-65 Hz 230 / 400 V 255 V - - 25 kA 100 kA 25 kA 60 kA 15 kA 1.5 kV 1.0 kV 334 V / - < 100 ns ≤ 50 kA ≤ 125 A ≤ 125 A No Yes Yes No Yes	T1-T2/I - II 4 TNC - TNS - TT (L-N) AC 45-65 Hz 230 / 400 V 255 V - - 25 kA 100 kA 25 kA 60 kA 15 kA 1.5 kV 1.0 kV 334 V / - < 100 ns ≤ 50 kA ≤ 125 A ≤ 125 A No Yes Yes No Yes
2.5...35 mm ² 2.5...25 mm ² 12.5 mm 2.8 Nm 1 NO - 1 NC 12 DC - 10 mA 250 V AC - 1 A 1.5 mm ² -40...+80 °C IP20 V0 88 x 71.2 x 76.7 mm 3.46 x 2.8 x 3.02 in 95.8 x 71.2 x 76.7 mm 3.77 x 2.8 x 3.02 in	2.5...35 mm ² 2.5...25 mm ² 12.5 mm 2.8 Nm 1 NO - 1 NC 12 DC - 10 mA 250 V AC - 1 A 1.5 mm ² -40...+80 °C IP20 V0 88 x 142.4 x 76.7 mm 3.46 x 5.61 x 3.02 in 95.8 x 142.4 x 76.7 mm 3.77 x 5.61 x 3.02 in	2.5...50 mm ² 2.5...35 mm ² 15 mm 3.5 Nm - - - - -40...+80 °C IP20 V0 85 x 89 x 70.8 mm 3.35 x 3.5 x 2.79 in -	2.5...50 mm ² 2.5...35 mm ² 15 mm 3.5 Nm 1 NO - 1 NC 12 V DC - 10 mA 250 V AC - 1 A 1.5 mm ² -40...+80 °C IP20 V0 93.5 x 71.2 x 65 mm 3.68 x 2.8 x 2.56 in	2.5...50 mm ² 2.5...35 mm ² 15 mm 3.5 Nm 1 NO - 1 NC 12 V DC - 10 mA 250 V AC - 1 A 1.5 mm ² -40...+80 °C IP20 V0 93.5 x 142.4 x 65 mm 3.68 x 5.61 x 2.56 in	2.5...50 mm ² 2.5...35 mm ² 15 mm 3.5 Nm 1 NO - 1 NC 12 V DC - 10 mA 250 V AC - 1 A 1.5 mm ² -40...+80 °C IP20 V0 93.5 x 142.4 x 65 mm 3.68 x 5.61 x 2.56 in
OVR T1-T2 12.5-275s C QS 2CTB815710R2600	OVR T1-T2 12.5-440s C QS 2CTB815710R5500	-	OVR T1+2 25-255 C 2CTB815101R3700	OVR T1+2 25-255 C 2CTB815101R3700	OVR T1+2 25-255 C 2CTB815101R3700

OVR Type 2 surge protective devices - Single pole 57 V networks

2



1TXH000095F0000

OVR T2 20 75 P

Description

Type 2 surge protective devices are designed to protect electric installations and sensitive equipment against indirect surges with ensuring a low protection level (Up). They are characterized by their capacity to safely discharge current with 8/20 µs wave form.

Ordering details

Pro- tect- ed lines	Max. dis- charge current Imax 8/20 kA	Nominal dis- charge current In kA	Voltage protec- tion level Up kV	Nominal voltage Un V	Max. cont. operating voltage Uc V	Bbn 3660308 EAN	Type	Order code	Weight Pkg (1 pce) kg
------------------------------	---	--	---	-------------------------------	--	---------------------------	------	------------	--

Type 2 pluggable - Uc 75 V

1	20	5	0.3	57	75	518446	OVR T2 20-75 P	2CTB803851R2800	0.12
1	20	5	0.3	57	75	518453	OVR T2 20-75 P TS	2CTB803851R2700	0.12
2	20	5	0.3	57	75	518484	OVR T2 2 20-75 P	2CTB803852R1700	0.23
2	20	5	0.3	57	75	518477	OVR T2 2 20-75 P TS	2CTB803852R1600	0.23

Main dimensions mm

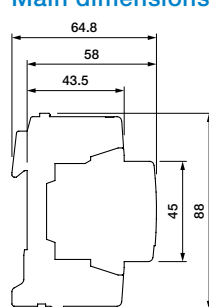

OVR T2 20-75 P
OVR T2 2 20-75 P

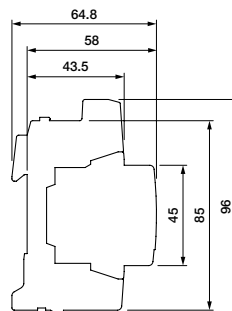

OVR T2 20-75 P TS
OVR T2 2 20-75 P TS

Type	Width mm
OVR T2 20-75 P	17.8
OVR T2 20-75 P TS	17.8
OVR T2 2 20-75 P	35.6
OVR T2 2 20-75 P TS	35.6

OVR Type 2 surge protective devices - Single pole 57 V networks

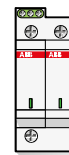

General technical data

		OVR T2 20-75 P	OVR T2 2 20-75 P
Types		OVR T2 20-75 P	OVR T2 2 20-75 P
with auxiliary contact (TS)		OVR T2 20-75 P TS	OVR T2 2 20-75 P TS
Technology		Varistor	Varistor
Electrical features			
Standard		IEC 61643-1 / EN 61643-11	
Type / test class		T2 / II	T2 / II
Protected lines		1	2
Types of networks		TNC - TNS - TT	TNC - TNS - TT
Type of current		AC - DC	AC - DC
Nominal AC voltage U_n		57 V	57 V
Max. cont. operating AC voltage U_c		75 V	75 V
Maximum discharge current I_{max} (8/20)		20 kA	20 kA
Nominal discharge current I_n (8/20)		5 kA	5 kA
Voltage protection level U_p at I_n		0.3 kV	0.3 kV
Voltage protection level U_p at 3 kA		0.25 kV	0.25 kV
TOV (Temporary overvoltage) withstand U_t (L-N: 5 s / N-PE: 200 ms)		75 V / -	75 V / -
Response time		≤ 25 ns	≤ 25 ns
Residual current IPE		25 μA	50 μA
Short-circuit withstand capability I_{scrr}		50 kA	50 kA
Backup protection		Fuse (gG - gL) ≤ 16 A	≤ 16 A
		Circuit breaker (B or C curve) ≤ 16 A	≤ 16 A
Pluggable cartridge		Yes	Yes
Integrated thermal disconnect		Yes	Yes
State indicator		Yes	Yes
Safety reserve		No	No
Auxiliary contact (TS)		Yes (TS option)	Yes (TS option)
Installation			
Wire range (L, N, PE)		Solid wire 2.5...25 mm ²	2.5...25 mm ²
		Stranded wire 2.5...16 mm ²	2.5...16 mm ²
Stripping length (L, N, PE)		12.5 mm	12.5 mm
Tightening torque (L, N, PE)		2.5 Nm	2.5 Nm
Auxiliary contact (TS)			
Contact complement		1 NO - 1 NC	1 NO - 1 NC
Minimum load		12 V DC - 10 mA	12 V DC - 10 mA
Maximum load		250 V AC - 1 A	250 V AC - 1 A
Connection cross-section		1.5 mm ²	1.5 mm ²
Miscellaneous characteristics			
Stocking and operating temperature		-40...+80 °C	-40...+80 °C
Degree of protection		IP20	IP20
Fire resistance according to UL 94		V0	V0
Dimensions		mm h x w x d 88 x 17.8 x 64.8 mm	88 x 35.6 x 64.8 mm
		inches h x w x d 3.46 x 0.7 x 2.55 in	3.46 x 1.4 x 2.55 in
Dimensions with auxiliary contact (TS)		mm h x w x d 96 x 17.8 x 64.8 mm	96 x 35.6 x 64.8 mm
		inches h x w x d 3.78 x 0.7 x 2.55 in	3.78 x 1.4 x 2.55 in
Replacement cartridges			
Phase product ID		Type OVR T2 20-75 C	OVR T2 20-75 C
		Order code 2CTB803854R1400	2CTB803854R1400

OVR Type 2 surge protective devices - Single pole - Unpluggable 120 V and 230 V networks

2



OVR T2 20-150

Description

Type 2 surge protective devices are designed to protect electric installations and sensitive equipment against indirect surges with ensuring a low protection level (U_p). They are characterized by their capacity to safely discharge current with 8/20 μ s wave form.

Ordering details

Pro- tect- ed lines	Max. dis- charge current I_{max} 8/20 kA	Nominal dis- charge current I_n kA	Voltage protec- tion level U_p kV	Nominal voltage U_n V	Max. cont. operating voltage U_c V	Bbn 3660308 EAN	Type	Order code	Weight Pkg (1 pce) kg
------------------------------	--	---	--	----------------------------------	---	---------------------------	------	------------	--

Type 2 unpluggable

1	20	5	0.6	120 ($\pm 15\%$)	150	518057	OVR T2 20-150	2CTB804200R0700	0.12
1	20	5	0.6	120 ($\pm 15\%$)	150	519405	OVR T2 20-150 (x20)	2CTB804200R1700	0.12
1	40	20	0.9	120 ($\pm 15\%$)	150	518064	OVR T2 40-150	2CTB804201R0700	0.12
1	40	20	0.9	120 ($\pm 15\%$)	150	519436	OVR T2 40-150 (x20)	2CTB804201R1700	0.12
1	20	5	1.0	230	275	514882	OVR T2 20-275	2CTB804200R0100	0.12
1	20	5	1.0	230	275	519382	OVR T2 20-275 (x20)	2CTB804200R1100	0.12
1	40	20	1.4	230	275	514103	OVR T2 40-275	2CTB804201R0100	0.12
1	40	20	1.4	230	275	519412	OVR T2 40-275 (x20)	2CTB804201R1100	0.12

(x20) packaging of 20 pieces.

Main dimensions mm

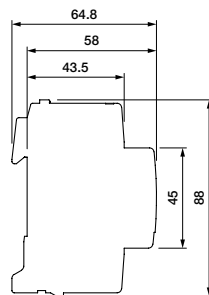

Type	Width mm
OVR T2 20-150	17.8
OVR T2 40-150	17.8
OVR T2 20-275	17.8
OVR T2 40-275	17.8

OVR T2 20-150
OVR T2 40-150
OVR T2 20-275
OVR T2 40-275

OVR Type 2 surge protective devices - Single pole - Unpluggable 120 V and 230 V networks



General technical data

	OVR T2 20-150	OVR T2 40-150	OVR T2 20-275	OVR T2 40-275
Types with auxiliary contact (TS)	-	-	-	-
Technology	Varistor	Varistor	Varistor	Varistor
Electrical features				
Standard	IEC 61643-1 / EN 61643-11			
Type / test class	T2 / II	T2 / II	T2 / II	T2 / II
Protected lines	1	1	1	1
Types of networks	TNC - TNS - TT	TNC - TNS - TT	TNC - TNS - TT	TNC - TNS - TT
Type of current	AC	AC	AC	AC
Nominal AC voltage Un	120 V (±15%)	120 V (±15%)	230 V	230 V
Max. cont. operating AC voltage Uc	150 V	150 V	275 V	275 V
Maximum discharge current I _{max} (8/20)	20 kA	40 kA	20 kA	40 kA
Nominal discharge current I _n (8/20)	5 kA	20 kA	5 kA	20 kA
Voltage protection level Up at I _n	0.6 kV	0.9 kV	1 kV	1.4 kV
Voltage protection level Up at 3 kA	0.6 kV	0.6 kV	0.9 kV	0.9 kV
TOV (Temporary overvoltage) withstand Ut (L-N: 5 s / N-PE: 200 ms)	175 V / -	175 V / -	337 V / -	337 V / -
Response time	≤ 25 ns	≤ 25 ns	≤ 25 ns	≤ 25 ns
Residual current IPE	25 µA	25 µA	25 µA	25 µA
Short-circuit withstand capability I _{sc}	50 kA	50 kA	50 kA	50 kA
Backup protection	Fuse (gG - gL)	≤ 50 A	≤ 50 A	≤ 50 A
	Circuit breaker (B or C curve)	≤ 50 A	≤ 50 A	≤ 50 A
Pluggable cartridge	No	No	No	No
Integrated thermal disconnecter	Yes	Yes	Yes	Yes
State indicator	Yes	Yes	Yes	Yes
Safety reserve	No	No	No	No
Auxiliary contact (TS)	No	No	No	No
Installation				
Wire range (L, N, PE)	Solid wire	2.5...25 mm ²	2.5...25 mm ²	2.5...25 mm ²
	Stranded wire	2.5...16 mm ²	2.5...16 mm ²	2.5...16 mm ²
Stripping length (L, N, PE)	12.5 mm	12.2 mm	12.2 mm	12.2 mm
Tightening torque (L, N, PE)	2.5 Nm	2.5 Nm	2.5 Nm	2.5 Nm
Auxiliary contact (TS)				
Contact complement	-	-	-	-
Minimum load	-	-	-	-
Maximum load	-	-	-	-
Connection cross-section	-	-	-	-
Miscellaneous characteristics				
Stocking and operating temperature	-40...+80 °C	-40...+80 °C	-40...+80 °C	-40...+80 °C
Degree of protection	IP20	IP20	IP20	IP20
Fire resistance according to UL 94	V0	V0	V0	V0
Dimensions	mm	h x w x d 88 x 17.8 x 64.8 mm	88 x 17.8 x 64.8 mm	88 x 17.8 x 64.8 mm
	inches	h x w x d 3.46 x 0.7 x 2.55 in	3.46 x 0.7 x 2.55 in	3.46 x 0.7 x 2.55 in

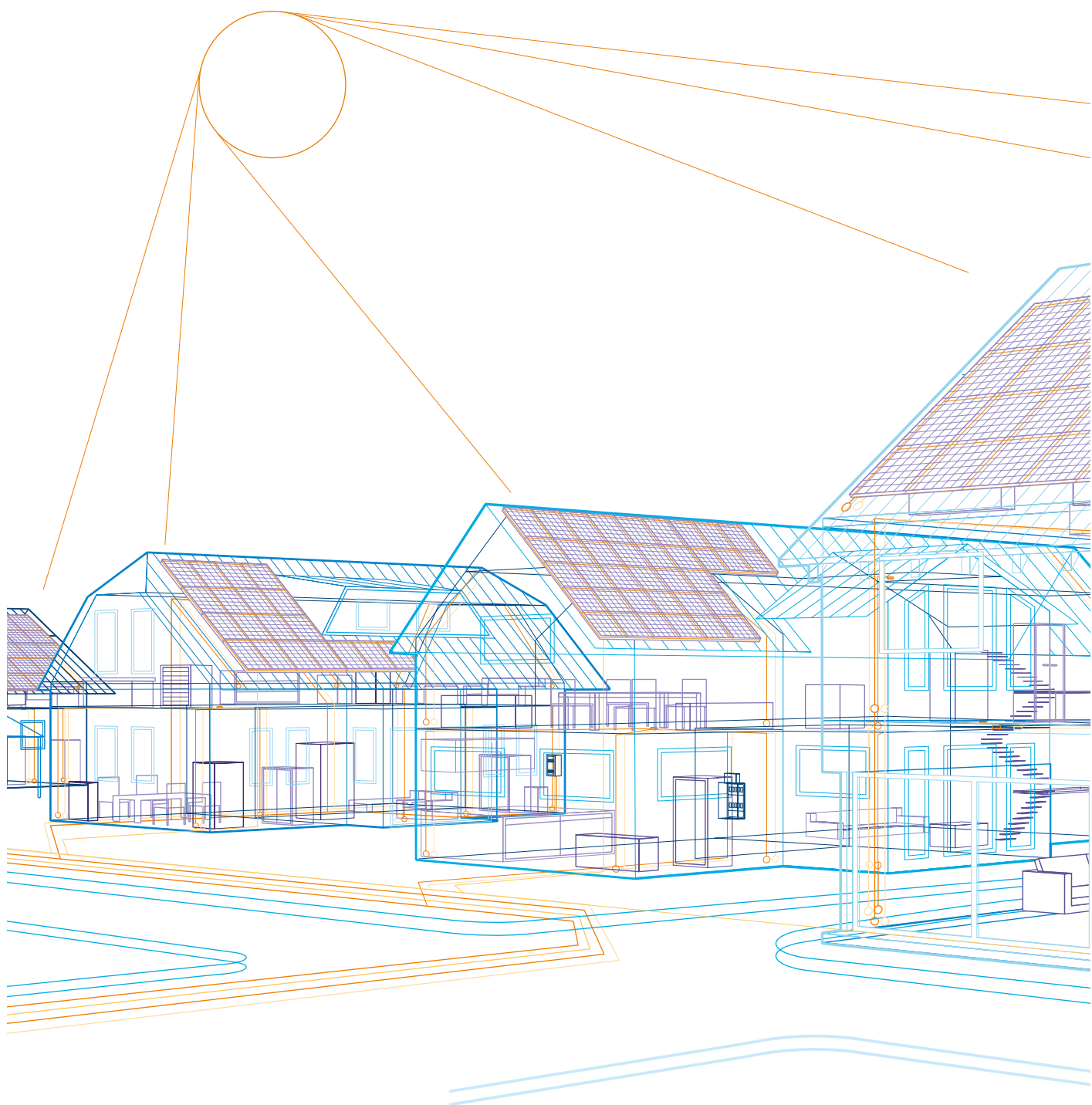

OVR Type 2 surge protective devices - Single pole - Pluggable 230 V networks



OVR T2 40-275 P QS

Description

Type 2 surge protective devices are designed to protect electric installations and sensitive equipment against indirect surges with ensuring a low protection level (U_p). They are characterized by their capacity to safely discharge current with 8/20 μ s wave form.

Ordering details

Protected lines	Max. discharge current I_{max} 8/20 kA	Nominal discharge current I_n kA	Voltage protection level U_p kV	Nominal voltage U_n V	Max. cont. operating voltage U_c V	Bbn 3660308 EAN	Type	Order code	Weight Pkg (1 pce) kg
Pluggable									
1	40	20	1.25	230	275	519580	OVR T2 40-275 P QS	2CTB803871R2300	0.12
1	40	20	1.25	230	275	519597	OVR T2 40-275 P TS QS	2CTB803871R1700	0.20
1	40	20	1.5	230	275	525291	OVR T2 40-275s P QS	2CTB815704R1200	0.15
1	40	20	1.5	230	275	525222	OVR T2 40-275s P TS QS*	2CTB815704R0000	0.15
1	40	20	1.5	230	350	520609	OVR T2 40-350 P QS	2CTB803881R2300	0.12
1	40	20	1.5	230	350	520562	OVR T2 40-350 P TS QS	2CTB803881R1700	0.12
1	80	30	1.8	230	275	525475	OVR T2 80-275s P QS*	2CTB815708R1200	0.15
1	80	30	1.8	230	275	525406	OVR T2 80-275s P TS QS*	2CTB815708R0000	0.15
1	80	30	1.4	230	275	519641	OVR T2 N 80-275 P QS	2CTB803973R1900	0.12
1	80	30	1.4	230	350	519658	OVR T2 N 80-350 P QS	2CTB803983R1900	0.12
1	80	30	1	230	275	525536	OVR T2 N 80-275s P QS*	2CTB815708R2500	0.12

* Products available end 2015.

Main dimensions mm

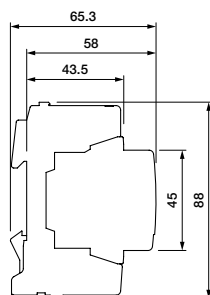

OVR T2 40-275 P QS
OVR T2 40-350 P QS
OVR T2 N 80-275 P QS
OVR T2 N 80-350 P QS
OVR T2 N 80-275s P QS

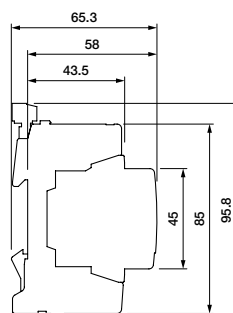

OVR T2 40-275 P TS QS
OVR T2 40-350 P TS QS

Type	Width mm
OVR T2 40-275 P QS	17.8
OVR T2 40-275 P TS QS	17.8
OVR T2 40-275s P QS	17.8
OVR T2 40-275s P TS QS	17.8
OVR T2 40-350 P QS	17.8
OVR T2 40-350 P TS QS	17.8
OVR T2 80-275s P QS	17.8
OVR T2 80-275s P TS QS	17.8
OVR T2 N 80-275 P QS	17.8
OVR T2 N 80-350 P QS	17.8
OVR T2 N 80-275s P QS	17.8

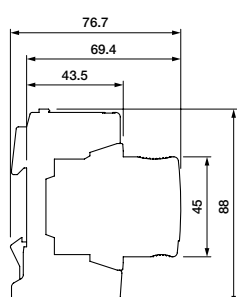

OVR T2 40-275s P QS
OVR T2 80-275s P QS

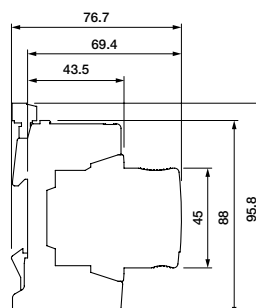

OVR T2 40-275s P TS QS
OVR T2 80-275s P TS QS

OVR Type 2 surge protective devices - Single pole - Pluggable 230 V networks

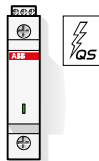

2

General technical data

Types	OVR T2 40-275 P QS	OVR T2 40-275s P QS	OVR T2 40-350 P QS
with auxiliary contact (TS)	OVR T2 40-275 P TS QS	OVR T2 40-275s P TS QS	OVR T2 40-350 P TS QS
Electrical features			
Standard	IEC 61643-11 / EN 61643-11		
Type / test class	T2 / II	T2 / II	T2 / II
Protected lines	1	1	1
System network	TNC - TNS - TT (P-N)	TNC - TNS - TT (P-N)	TNC - TNS - TT (P-N)
Type of current	AC 45-65 Hz	AC 45-65 Hz	AC 45-65 Hz
Voltage regulation of the system network	±20%	±20%	±50%
Nominal system voltage Un	230 V	230 V	230 V
Max. cont. operating voltage Uc	275 V	275 V	350 V
Nominal DC voltage Undc L-PE	320 kV	320 kV	375 kV
Max. DC. cont. operating voltage Ucdc L-PE	355 kV	355 kV	415 kV
Maximum discharge current Imax (8/20)	40 kA	40 kA	40 kA
Maximum impulse current Iimp (10/350)	2 kA	2 kA	2 kA
Maximum impulse current Tot. Iimp (10/350)	-	-	-
Nominal discharge current In (8/20)	20 kA	20 kA	20 kA
Follow current interrupting rating I _{fi}	-	-	-
Voltage protection level Up at In (L-N)	1.25 kV	1.5 kV	1.5 kV
Voltage protection level Up at 3kA (L-N)	0.8 kV	0.5 kV	1 kV
Voltage protection level Up at 5kA (L-N)	0.85 kV	0.7 kV	1.05 kV
Voltage protection level Up at 10kA (L-N)	1 kV	0.9 kV	1.2 kV
TOV (Temporary overvoltage) withstand Ut (L-N: 5 s./N-PE: 200 ms)	337 V / -	337 V / -	455 V / -
Response time	< 25 ns	< 25 ns	< 25 ns
Short-circuit withstand capability Isccr	100 kA	100 kA	100 kA
Backup protection fuse (gG - gL)	≤ 125 A	≤ 125 A	≤ 125 A
maximum rating circuit breaker (B or C curve)	≤ 125 A	≤ 125 A	≤ 125 A
Pluggable cartridge	Yes	Yes	Yes
Integrated QuickSafe® technology	Yes	Yes	Yes
State indicator	Yes	Yes	Yes
Safety reserve	No	Yes	No
Auxiliary contact (TS)	Yes (TS option)	Yes (TS option)	Yes (TS option)
Installation			
Wire range (L, N, PE)	solid wire 2.5...25 mm ²	2.5...25 mm ²	2.5...25 mm ²
	stranded wire 2.5...16 mm ²	2.5...16 mm ²	2.5...16 mm ²
Stripping length (L, N, PE)	12.5 mm	12.5 mm	12.5 mm
Tightening torque (L, N, PE)	2.8 Nm	2.8 Nm	2.8 Nm
Auxiliary contact (TS)			
Contacts information	1 NO - 1 NC	1 NO - 1 NC	1 NO - 1 NC
Min. load	12 DC - 10 mA	12 DC - 10 mA	12 DC - 10 mA
Max. load	250 V AC - 1 A	250 V AC - 1 A	250 V AC - 1 A
Connection cross-section	1.5 mm ²	1.5 mm ²	1.5 mm ²
Miscellaneous characteristics			
Stocking and operating temperature	-40...+80 °C	-40...+80 °C	-40...+80 °C
Degree of protection	IP20	IP20	IP20
Fire resistance according to UL 94	VO	VO	VO
Dimensions	mm h x w x d 88 x 17.8 x 65.3 mm	88 x 17.8 x 76.7 mm	88 x 17.8 x 65.3 mm
	inches h x w x d 3.46 x 0.7 x 2.57 in	3.46 x 0.7 x 3.02 in	3.46 x 0.7 x 2.57 in
Dimensions with auxiliary contact (TS)	mm h x w x d 95.8 x 17.8 x 65.3 mm	95.8 x 17.8 x 76.7 mm	95.8 x 17.8 x 65.3 mm
	inches h x w x d 3.77 x 0.7 x 2.57 in	3.77 x 0.7 x 3.02 in	3.77 x 0.7 x 2.57 in
Replacement cartridges			
Phase product ID	Type OVR T2 40-275 C QS	OVR T2 40-275s C QS	OVR T2 40-350 C QS
	Order code 2CTB803876R1000	2CTB815704R2600	2CTB803886R1000
Neutral product ID	Type -	-	-
	Order code -	-	-

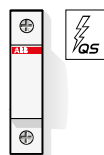
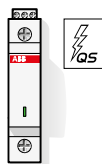

OVR T2 80-275s P QS OVR T2 80-275s P TS QS	OVR T2 N 80-275 P QS	OVR T2 N 80-350 P QS	OVR T2 N 80-275s P QS
T2 / II 1 TNC - TNS - TT (L-N) AC 45-65 Hz ±20% 230 V 275 V 320 kV - 80 kA 6.25 kA - 30 kA - 1.8 kV 0.5 kV 0.7 kV 0.9 kV 337 V / - < 25 ns 100 kA ≤ 160 A ≤ 125 A Yes Yes Yes Yes Yes (TS option) 2.5...25 mm ² 2.5...35 mm ² 12.5 mm 2.8 Nm 1 NO - 1 NC 12 DC - 10 mA 250 V AC - 1 A 1.5 mm ² -40...+80 °C IP20 VO 88 x 17.8 x 76.7 mm 3.46 x 0.7 x 3.02 in 95.8 x 17.8 x 76.7 mm 3.77 x 0.7 x 3.02 in OVR T2 80-275s C QS 2CTB815708R2600 - -	T2 / II 1 TT (N-PE) AC 45-65 Hz ±20% 230 V 275 V - 80 kA 2 kA - 30 kA - 1.4 kV - - - - / 1200 V < 25 ns - - - Yes - Yes No No 2.5...25 mm ² 2.5...16 mm ² 12.5 mm 2.8 Nm - - - - -40...+80 °C IP20 VO 88 x 17.8 x 65.3 mm 3.46 x 0.7 x 2.57 in - - OVR T2 N 80-275 C QS 2CTB803876R0000	T2 / II 1 TT (N-PE) AC 45-65 Hz ±50% 230 V 350 V - 80 kA - - 30 kA - 1.4 kV - - - - / 1200 V < 25 ns - - - Yes - Yes No No 2.5...25 mm ² 2.5...16 mm ² 12.5 mm 2.8 Nm - - - - -40...+80 °C IP20 VO 88 x 17.8 x 65.3 mm 3.46 x 0.7 x 2.57 in - - OVR T2 N 80-350 C QS 2CTB803886R0000	T2 1 TT (N-PE) AC 45-65 Hz - 230 V 275 V - 80 kA - - 30 kA - 1 kV - - - - / 1200 V < 25 ns 100 kA - - - No - No No 2.5...50 mm ² 2.5...35 mm ² 15 mm 3.5 Nm - - - - -40...+80 °C IP20 VO 88 x 17.8 x 65.3 mm 3.46 x 0.7 x 2.57 in - - OVR T2 N 80-275s C QS 2CTB815708R2800

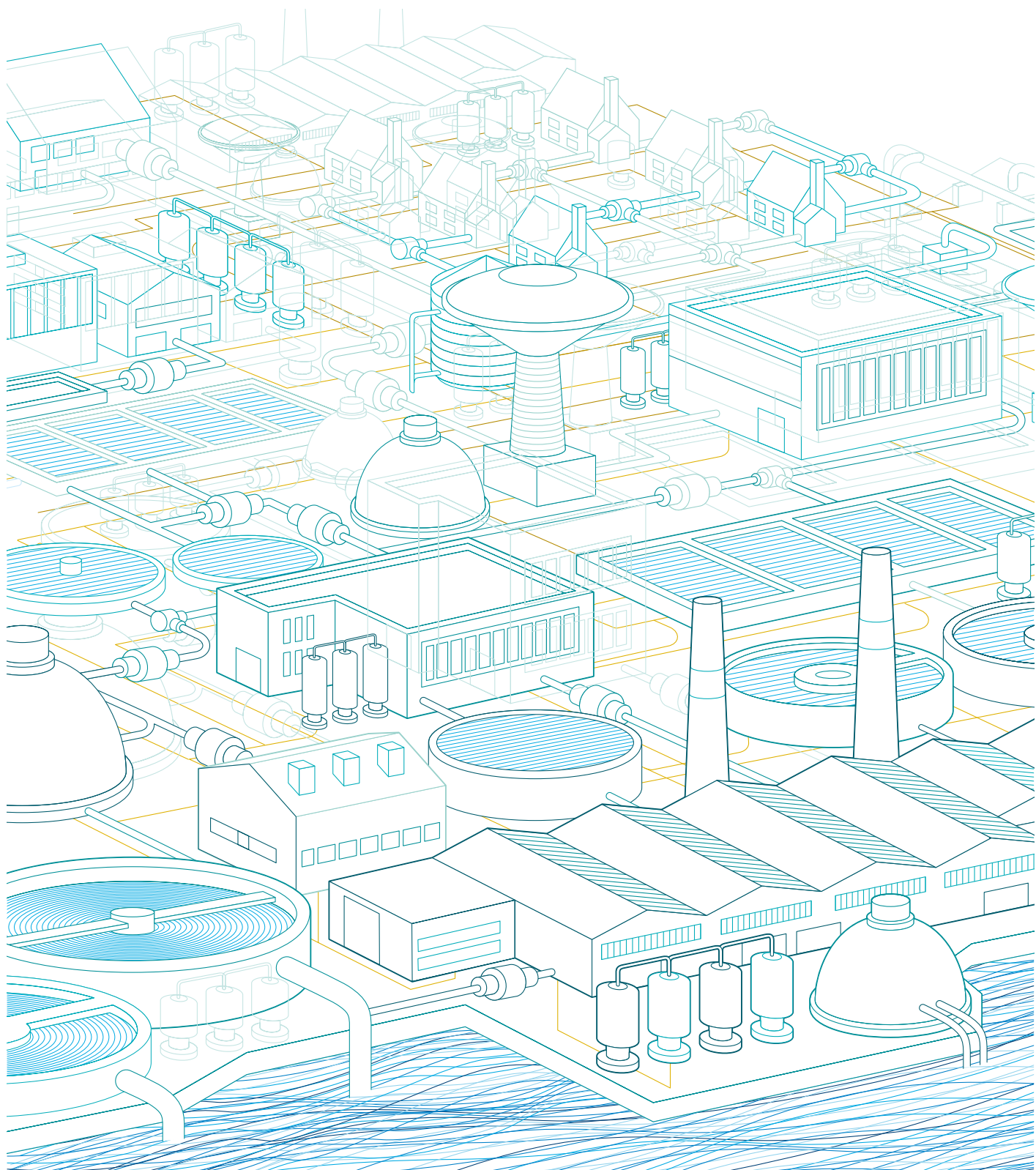

2CTC432005S0201

OVR Type 2 surge protective devices - Single pole 400 V networks



OVR T2 80-440s P TS QS

Description

Type 2 surge protective devices are designed to protect electric installations and sensitive equipment against indirect surges with ensuring a low protection level (Up). They are characterized by their capacity to safely discharge current with 8/20 μs wave form.

Ordering details

Protected lines	Max. discharge current I _{max} 8/20 kA	Nominal discharge current I _n kA	Voltage protection level U _p kV	Nominal voltage U _n V	Max. cont. operating voltage U _c V	Bbn 3660308 EAN	Type	Order code	Weight Pkg (1 pce) kg
-----------------	---	---	--	----------------------------------	---	-----------------	------	------------	-----------------------

Type 2 unpluggable - Uc 440 V

1	20	5	1.3	400	440	518071	OVR T2 20-440	2CTB804200R0200	0.12
1	20	5	1.3	400	440	519399	OVR T2 20-440 (x20)	2CTB804200R1200	0.12
1	40	20	1.9	400	440	518088	OVR T2 40-440	2CTB804201R0200	0.12
1	40	20	1.9	400	440	519429	OVR T2 40-440 (x20)	2CTB804201R1200	0.12

Type 2 pluggable - Uc 440 V

1	40	20	1.8	400	440	519627	OVR T2 40-440 P QS	2CTB803871R1200	0.12
1	40	20	2	400	440	519634	OVR T2 40-440 P TS QS	2CTB803871R0500	0.12
1	40	20	2	400	440	525383	OVR T2 40-440s P QS*	2CTB815704R4100	0.30
1	40	20	2	400	440	525369	OVR T2 40-440s P TS QS*	2CTB815704R2900	0.30
1	80	30	2.4	400	440	525604	OVR T2 80-440s P QS*	2CTB815708R4100	0.30
1	80	30	2.4	400	440	525567	OVR T2 80-440s P TS QS*	2CTB815708R2900	0.30
1	40	20	2.3	400	600	520579	OVR T2 40-600 P TS QS	2CTB803881R0500	0.12
1	80	30	-	400	440	519665	OVR T2 N 80-440 P QS	2CTB803973R2000	0.12
1	80	30	-	400	440	525642	OVR T2 N 80-440s P QS*	2CTB815708R5400	0.12
1	120	60	2.5	400	440	517067	OVR T2 120-440s P TS	2CTB803951R1300	0.25

* Products available end 2015.
(x20) packaging of 20 pieces.

Main dimensions mm

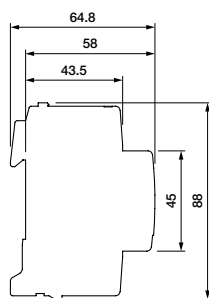

OVR T2 20-440
OVR T2 40-440

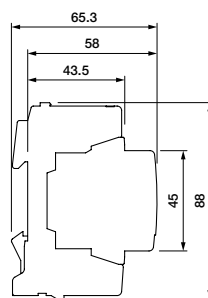

OVR T2 40-440 P QS
OVR T2 N 80-440 P QS

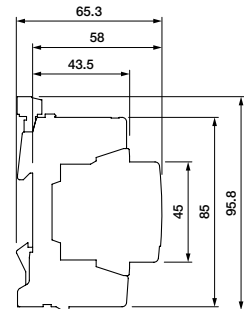

OVR T2 40-440 P TS QS
OVR T2 40-600 P TS QS

Type	Width mm
OVR T2 20-440	17.8
OVR T2 40-440	17.8
OVR T2 40-440 P QS	17.8
OVR T2 40-440 P TS QS	17.8
OVR T2 40-440s P QS	17.8
OVR T2 40-440s P TS QS	17.8
OVR T2 80-440s P QS	17.8
OVR T2 80-440s P TS QS	17.8
OVR T2 40-600 P TS QS	17.8
OVR T2 N 80-440 P QS	17.8
OVR T2 N 80-440s P QS	17.8
OVR T2 120-440s P TS	35.6

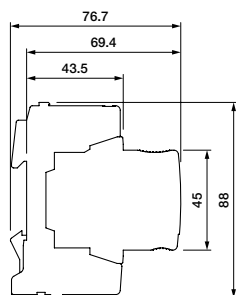

OVR T2 40-440s P QS
OVR T2 80-440s P QS
OVR T2 N 80-440s P QS

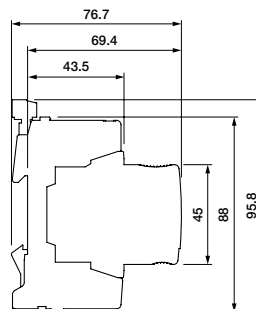

OVR T2 40-440s P TS QS
OVR T2 80-440s P TS QS

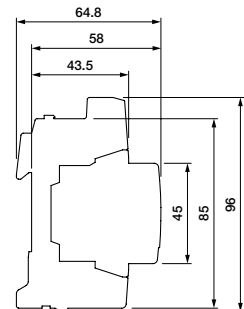

OVR T2 120-440s P TS

OVR Type 2 surge protective devices - Single pole 400 V networks

2

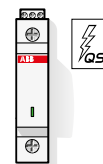

General technical data

Types	OVR T2 20-440		OVR T2 40-440	OVR T2 40-440 P QS
with auxiliary contact (TS)	-		-	OVR T2 40-440 P TS QS
Electrical features				
Standard	IEC 61643-11 / EN 61643-11			
Type / test class	T2 / II		T2 / II	T2 / II
Protected lines	1		1	1
System network	TNC - TNS - TT (P-N) - IT (230 V)		TNC - TNS - TT (P-N) - IT (230 V)	TNC - TNS - TT (P-N) - IT (230 V)
Type of current	AC 45-65 Hz / DC		AC 45-65 Hz / DC	AC 45-65 Hz / DC
Voltage regulation of the system network	-		-	±10%
Nominal system voltage Un	400 V		400 V	400 V
Max. cont. operating voltage Uc	440 V		440 V	440 V
Nominal DC voltage Undc L-PE	-		-	495 V DC
Max. DC cont. operating voltage Ucdc L-PE	-		-	545 V DC
Maximum discharge current Imax (8/20)	20 kV		40 kV	40 kA
Maximum impulse current Iimp (10/350)	-		-	2 kA
Nominal discharge current In (8/20)	5 kA		20 kA	20 kA
Voltage protection level Up at In (L-N)	1.3 kV		1.9 kV	1.8 kV
Voltage protection level Up at 3 kA (L-N)	1.2 kV		1.3 kV	1.25 kV
Voltage protection level Up at 5 kA (L-N)	-		-	1.35 kV
Voltage protection level Up at 10 kA (L-N)	-		-	1.5 kV
TOV (Temporary overvoltage) withstand Ut (L-N: 5s./N-PE: 200 ms)	440 V / -		440 V / -	581 V / -
Response time	< 25 ns		< 25 ns	25 ns
Short-circuit withstand capability Isccr	≤ 50 kA		≤ 50 kA	100 kA
Backup protection	fuse (gG - gL)		≤ 50 A	≤ 125 A
maximum rating	circuit breaker (B or C curve)		≤ 50 A	≤ 125 A
Pluggable cartridge	No		No	Yes
Integrated QuickSafe® technology	Yes		Yes	Yes
State indicator	No		No	Yes
Safety reserve	No		No	No
Auxiliary contact (TS)	No		No	Yes (TS option)
Installation				
Wire range (L, N, PE)	solid wire	2.5...25 mm ²	2.5...25 mm ²	2.5...25 mm ²
	stranded wire	2.5...16 mm ²	2.5...16 mm ²	2.5...16 mm ²
Stripping length (L, N, PE)		12.2 mm	12.2 mm	12.5 mm
Tightening torque (L, N, PE)		2.5 Nm	2.5 Nm	2.8 Nm
Auxiliary contact (TS)				
Contacts information	-		-	1 NO - 1 NC
Min. load	-		-	12 DC - 10 mA
Max. load	-		-	250 V AC - 1 A
Connection cross-section	-		-	1.5 mm ²
Miscellaneous characteristics				
Stocking and operating temperature	-40...+80 °C		-40...+80 °C	-40...+80 °C
Degree of protection	IP20		IP20	IP20
Fire resistance according to UL 94	V0		V0	V0
Dimensions	mm	h x w x d 88 x 17.8 x 64.8 mm	88 x 17.8 x 64.8 mm	88 x 17.8 x 65.3 mm
	inches	h x w x d 3.46 x 0.7 x 2.55 in	3.46 x 0.7 x 2.55 in	3.46 x 0.7 x 2.57 in
Dimensions with auxiliary contact (TS)	mm	h x w x d -	-	95.8 x 17.8 x 65.3 mm
	inches	h x w x d -	-	3.77 x 0.7 x 2.57 in
Replacement cartridges				
Phase product ID	Type	-	-	OVR T2 40-440 C
	Order code	-	-	2CTB803876R0400
Neutral product ID	Type	-	-	-
	Order code	-	-	-

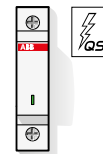
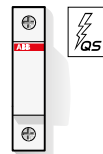
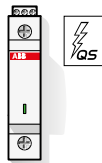

OVR T2 40-440s P QS	OVR T2 80-440s P QS	-	OVR T2 N 80-440 P QS	OVR T2 N 80-440s P QS	-
OVR T2 40-440s P TS QS	OVR T2 80-440s P TS QS	OVR T2 40-600 P TS QS	-	-	OVR T2 120-440s P TS
T2 / II 1	T2 / II 1	T2 / II 1	T2 / II 1	T2 1	T2 1
TNC - TNS - TT (L-N) - IT (230 V) AC 45-65 Hz / DC	TNC - TNS - TT (L-N) - IT (230 V) AC 45-65 Hz / DC	TNC - TNS - TT (P-N) - IT (230 V) AC 45-65 Hz / DC	TT (N-PE) AC 45-65 Hz	TT (N-PE) AC 45-65 Hz	TNC - TNS - TT AC 45-65 Hz
±10%	±10%	±50%	±10%	-	-
400 V	400 V	400 V	400 V	400 V	400 V
440 V	440 V	600 V	440 V	440 V	440 V
495 V DC	495 V DC	650 V DC	-	-	-
545 V DC	545 V DC	715 V DC	-	-	-
40 kA	80 kA	40 kA	80 kA	80 kA	120 kA
2 kA	6.25 kA	2 kA	2 kA	6.25 kA	-
30 kA	30 kA	20 kA	30 kA	30 kA	60 kA
2 kV	2.4 kV	2.3 kV	1.4 kV	1 kV	2.5 kV
0.8 kV	0.8 kV	1.6 kV	-	-	1.1 kV
1.2 kV	1.2	1.7 kV	-	-	-
1.55	0	1.9 kV	-	-	-
581 V / -	581 V / -	792 V / -	- / 1200 V	- / 1200 V	440 V / -
25 ns	25 ns	25 ns	< 25 ns	< 25 ns	< 25 ns
100 kA	100 kA	100 kA	-	100 kA	50 kA
≤ 160 A	≤ 160 A	≤ 125 A	≤ 125 A	≤ 160 A	≤ 50 A
≤ 125 A	≤ 125 A	≤ 125 A	≤ 125 A	≤ 160 A	≤ 50 A
Yes	Yes	Yes	Yes	No	Yes
Yes	Yes	Yes	Yes	-	Yes
Yes	Yes	Yes	Yes	No	Yes
Yes	Yes	No	No	No	Yes
Yes (TS option)	Yes (TS option)	Yes	No	No	Yes
2.5...25 mm ²	2.5...25 mm ²	2.5...25 mm ²	2.5...25 mm ²	2.5...50 mm ²	2.5...50 mm ²
2.5...35 mm ²	2.5...35 mm ²	2.5...16 mm ²	2.5...16 mm ²	2.5...35 mm ²	2.5...35 mm ²
12.5 mm	12.5 mm	12.5 mm	12.5 mm	15 mm	15 mm
2.8 Nm	2.8 Nm	2.8 Nm	2.8 Nm	3.5 Nm	3.5 Nm
1 NO - 1 NC	1 NO - 1 NC	1 NO - 1 NC	-	1 NO - 1 NC	1 NO - 1 NC
12 DC - 10 mA	12 DC - 10 mA	12 DC - 10 mA	-	12 V DC - 10 mA	12 V DC - 10 mA
250 V AC - 1 A	250 V AC - 1 A	250 V AC - 1 A	-	250 V AC - 1 A	250 V AC - 1 A
1.5 mm ²	1.5 mm ²	1.5 mm ²	-	1.5 mm ²	1.5 mm ²
-40...+80 °C	-40...+80 °C	-40...+80 °C	-40...+80 °C	-40...+80 °C	-40...+80 °C
IP20	IP20	IP20	IP20	IP20	IP20
V0	V0	V0	V0	V0	V0
88 x 17.8 x 76.7 mm	88 x 17.8 x 76.7 mm	-	88 x 17.8 x 65.3 mm	88 x 17.8 x 76.7 mm	-
3.46 x 0.7 x 3.02 in	3.46 x 0.7 x 3.02 in	-	3.46 x 0.7 x 2.57 in	3.46 x 0.7 x 3.02 in	-
95.8 x 17.8 x 76.7 mm	95.8 x 17.8 x 76.7 mm	95.8 x 17.8 x 65.3 mm	-	-	96 x 35.6 x 64.8 mm
3.77 x 0.7 x 3.02 in	3.77 x 0.7 x 3.02 in	3.77 x 0.7 x 2.57 in	-	-	3.78 x 1.4 x 2.55 in
OVR T2 40-440s C QS	OVR T2 80-440s C QS	OVR T2 40-600 C QS	-	-	OVR T2 70 440s C
2CTB815704R5500	2CTB815708R5500	2CTB803886R0400	-	-	2CTB803854R0100
-	-	-	OVR T2 N 80-440 C QS	OVR T2 N 80-440s C QS	-
-	-	-	2CTB803886R0100	2CTB815708R2800	-

OVR Type 2 surge protective devices

TNC - 230 V networks

2



OVRT23L40275SP1

OVR T2 3L 20-275



2CTC43232V0014

OVR T2 3L 40-275 P QS

Description

Type 2 surge protective devices are designed to protect electric installations and sensitive equipment against indirect surges with ensuring a low protection level (Up). They are characterized by their capacity to safely discharge current with 8/20 µs wave form.

Ordering details

Protected lines	Max. discharge current I _{max} 8/20 kA	Nominal discharge current I _n kA	Voltage protection level U _p kV	Nominal voltage U _n V	Max. cont. operating voltage U _c V	Bbn 3660308 EAN	Type	Order code	Weight Pkg (1 pce) kg
-----------------	---	---	--	----------------------------------	---	--------------------	------	------------	--------------------------

Type 2 unpluggable - U_c 275 V

3	20	5	1.0	230/400	275	515957	OVR T2 3L 20-275	2CTB804600R0400	0.35
3	40	20	1.4	230/400	275	515964	OVR T2 3L 40-275	2CTB804601R0400	0.35

Type 2 pluggable - U_c 275 V

3	40	20	1.25	230/400	275	519825	OVR T2 3L 40-275 P QS	2CTB803873R2400	0.36
3	40	20	1.25	230/400	275	519832	OVR T2 3L 40-275 P TS QS	2CTB803873R2500	0.36
3	40	30	1.5	230/400	275	525314	OVR T2 3L 40-275s P QS*	2CTB815704R1800	0.45
3	40	30	1.5	230/400	275	525253	OVR T2 3L 40-275s P TS QS*	2CTB815704R0600	0.45
3	80	30	1.8	230/400	275	525499	OVR T2 3L 80-275s P QS*	2CTB815708R1800	0.45
3	80	30	1.8	230/400	275	525437	OVR T2 3L 80-275s P TS QS*	2CTB815708R0600	0.45
3	40	20	1.5	230/400	350	519849	OVR T2 3L 40-350 P QS	2CTB803883R2400	0.36
3	40	20	1.5	230/400	350	519856	OVR T2 3L 40-350 P TS QS	2CTB803883R2500	0.36

* Products available on end 2015.

Main dimensions mm

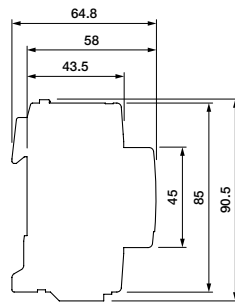

OVR T2 3L 20-275
OVR T2 3L 40-275

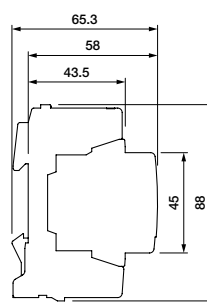

OVR T2 3L 40-275 P QS
OVR T2 3L 40-350 P QS

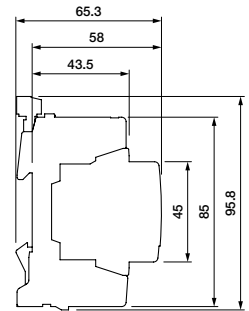

OVR T2 3L 40-275 P TS QS
OVR T2 3L 40-350 P TS QS

Type	Width mm
OVR T2 3L 20-275	53.4
OVR T2 3L 40-275	53.4
OVR T2 3L 40-275 P QS	53.4
OVR T2 3L 40-275 P TS QS	53.4
OVR T2 3L 40-275s P QS	53.4
OVR T2 3L 40-275s P TS QS	53.4
OVR T2 3L 80-275s P QS	53.4
OVR T2 3L 80-275s P TS QS	53.4
OVR T2 3L 40-350 P QS	53.4
OVR T2 3L 40-350 P TS QS	53.4

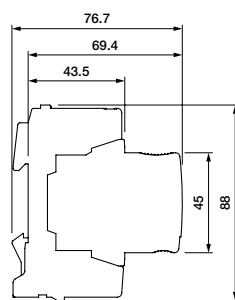

OVR T2 3L 40-275s P QS
OVR T2 3L 80-275s P QS

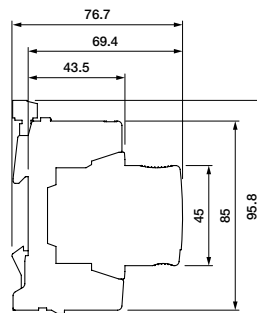

OVR T2 3L 40-275s P TS QS
OVR T2 3L 80-275s P TS QS

OVR Type 2 surge protective devices

TNC - 230 V networks

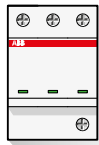

General technical data

Types	OVR T2 3L 20-275	OVR T2 3L 40-275	OVR T2 3L 40-275 P QS	OVR T2 3L 40-275s P QS	OVR T2 3L 80-275s P QS	OVR T2 3L 40-350 P QS
with auxiliary contact (TS)	-	-	OVR T2 3L 40-275 P TS QS	OVR T2 3L 40-275s P TS QS	OVR T2 3L 80-275s P TS QS	OVR T2 3L 40-350 P TS QS
Electrical features						
Standard	IEC 61643-11 / EN 61643-11					
Type / test class	T1+2 / I - II			T2 / II		
Protected lines	3	3	3	3	3	3
System network	TNC	TNC	TNC	TNC	TNC	TNC
Type of current	AC 45-65 Hz	AC 45-65 Hz	AC 45-65 Hz	AC 45-65 Hz	AC 45-65 Hz	AC 45-65 Hz
Voltage regulation of the system network	-	-	±20%	±20%	±20%	±50%
Nominal system voltage Un (L-PEN / L-L)	230 / 400 V	230 / 400 V	230 / 400 V	230 / 400 V	230 / 400 V	230 / 400 V
Max. cont. operating voltage Uc (L-PEN)	275 V	275 V	275 V	275 V	275 V	350 V
Nominal DC voltage Udc (L-PE / L-L)	-	-	320 / 640 V	320 / 640 V	320 / 640 V	375 / 750 V
Max. DC cont. operating voltage Ucdc (L-PE / L-L)	-	-	355 / 710 V	355 / 710 V	355 / 710 V	415 / 830 V
Maximum discharge current Imax (8/20)	20 kA	40 kA	40 kA	40 kA	80 kA	40 kA
Maximum impulse current Iimp (10/350)	-	-	2 kA	2 kA	6.25 kA	2 kA
Nominal discharge current In (8/20)	5 kA	20 kA	20 kA	20 kA	30 kA	20 kA
Voltage protection level Up at In	1 kV	1.4 kV	1.25 kV	1.5 kV	1.8 kV	1.5 kV
Voltage protection level Up at 3 kA	0.9 kV	0.9 kV	0.8 kV	0.5 kV	0.5 kV	1.0 kV
Voltage protection level Up at 5 kA	-	-	0.85 kV	0.7 kV	0.7 kV	1.05 kV
Voltage protection level Up at 10k A	-	-	1.0 kV	0.9 kV	0.9 kV	1.2 kV
TOV (Temporary overvoltage) withstand Ut (L-N: 5 s / N-PE: 200 ms)	334 V / -	334 V / -	337 V / -	337 V / -	337 V / -	455 V / -
Response time	≤ 50 ns	≤ 50 ns	≤ 25 ns	≤ 25 ns	≤ 25 ns	≤ 25 ns
Short-circuit withstand capability Iscsr	50 kA	50 kA	100 kA	100 kA	100 kA	100 kA
Backup protection fuse (gG - gL) maximum rating	≤ 50 kA	≤ 50 kA	≤ 125 A	≤ 160 A	≤ 160 A	≤ 125 A
Backup protection circuit breaker (B or C curve) maximum rating	≤ 50 kA	≤ 50 kA	≤ 125 A	≤ 125 A	≤ 125 A	≤ 125 A
Pluggable cartridge	No	No	Yes	Yes	Yes	Yes
Integrated thermal disconnecter	Yes	Yes	-	-	-	-
Integrated QuickSafe® technology	-	-	Yes	Yes	Yes	Yes
State indicator	No	No	Yes	Yes	Yes	Yes
Safety reserve	No	No	No	Yes	Yes	No
Auxiliary contact (TS)	No	No	Yes (TS option)	Yes (TS option)	Yes (TS option)	Yes (TS option)
Installation						
Wire range (L, N, PE) solid wire	2.5...25 mm ²	2.5...25 mm ²	2.5...25 mm ²	2.5...25 mm ²	2.5...25 mm ²	2.5...25 mm ²
Wire range (L, N, PE) stranded wire	2.5...16 mm ²	2.5...16 mm ²	2.5...16 mm ²	2.5...35 mm ²	2.5...35 mm ²	2.5...16 mm ²
Stripping length (L, N, PE)	12.5 mm	12.5 mm	12.5 mm	12.5 mm	12.5 mm	12.5 mm
Tightening torque (L, N, PE)	2.5 Nm	2.5 Nm	2.8 Nm	2.8 Nm	2.8 Nm	2.8 Nm
Auxiliary contact (TS)						
Contacts information	-	-	1 NO - 1 NC	1 NO - 1 NC	1 NO - 1 NC	1 NO - 1 NC
Min. load	-	-	12 V DC - 10 mA	12 V DC - 10 mA	12 V DC - 10 mA	12 V DC - 10 mA
Max. load	-	-	250 V AC - 1 A	250 V AC - 1 A	250 V AC - 1 A	250 V AC - 1 A
Connection cross-section	-	-	1.5 mm ²	1.5 mm ²	1.5 mm ²	1.5 mm ²
Miscellaneous characteristics						
Stocking and operating temperature	-40...+80 °C	-40...+80 °C	-40...+80 °C	-40...+80 °C	-40...+80 °C	-40...+80 °C
Degree of protection	IP20	IP20	IP20	IP20	IP20	IP20
Fire resistance according to UL 94	V0	V0	V0	V0	V0	V0
Dimensions						
mm h x w x d	90.5 x 53.4 x 64.8 mm	90.5 x 53.4 x 64.8 mm	88 x 53.4 x 65.3 mm	88 x 53.4 x 76.7 mm	88 x 53.4 x 76.7 mm	88 x 53.4 x 65.3 mm
inches h x w x d	3.56 x 2.1 x 2.55 in	3.56 x 2.1 x 2.55 in	3.46 x 2.1 x 2.57 in	3.46 x 2.1 x 3.02 in	3.46 x 2.1 x 3.02 in	3.46 x 2.1 x 2.57 in
Dimensions with auxiliary contact (TS)						
mm h x w x d	-	-	95.8 x 53.4 x 65.3 mm	95.8 x 53.4 x 76.7 mm	95.8 x 53.4 x 76.7 mm	95.8 x 53.4 x 65.3 mm
inches h x w x d	-	-	3.77 x 2.1 x 2.57 in	3.77 x 2.1 x 3.02 in	3.77 x 2.1 x 3.02 in	3.77 x 2.1 x 2.57 in
Replacement cartridges						
Phase product ID						
Type	-	-	OVR T2 40-275 C QS	OVR T2 40-275s C QS	OVR T2 80-275s C QS	OVR T2 40-350 C QS
Order code	-	-	2CTB803876R1000	2CTB815704R2600	2CTB8157084R2600	2CTB803886R1000
Neutral product ID						
Type	-	-	-	-	-	-
Order code	-	-	-	-	-	-

OVR Type 2 surge protective devices

TNC - 400 V networks

2

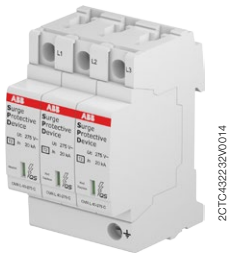

OVR T2 3L 40-440 P QS

2CTC432232V0014

Description

Type 2 surge protective devices are designed to protect electric installations and sensitive equipment against indirect surges with ensuring a low protection level (Up). They are characterized by their capacity to safely discharge current with 8/20 µs wave form.

Ordering details

Pro- tect- ed lines	Max. dis- charge current I _{max} 8/20 kA	Nominal dis- charge current I _n kA	Voltage protec- tion level U _p kV	Nominal voltage U _n V	Max. cont. operating voltage U _c V	Bbn 3660308 EAN	Type	Order code	Weight Pkg (1 pce) kg
------------------------------	---	--	---	---	--	---------------------------	------	------------	--

Pluggable

3	40	20	1.8	400/690	440	521064	OVR T2 3L 40-440 P QS	2CTB803873R2800	0.48
3	40	20	1.8	400/690	440	519870	OVR T2 3L 40-440 P TS QS	2CTB803873R2700	0.48
3	80	30	2.4	400/690	440	525611	OVR T2 3L 80-440s P QS*	2CTB815708R4700	1.20
3	80	30	2.4	400/690	440	525574	OVR T2 3L 80-440s P TS QS*	2CTB815708R3500	1.20
3	40	15	2.9	400/690	440	515629	OVR T2 3L 40-400/690 P	2CTB803853R4500	0.48
3	40	15	2.9	400/690	440	515636	OVR T2 3L 40-400/690 P TS	2CTB803853R4600	0.48
3	40	20	2.3	400/690	600	520678	OVR T2 3L 40-600 P TS QS	2CTB803883R2700	0.48

* Products available end 2015.

Main dimensions mm

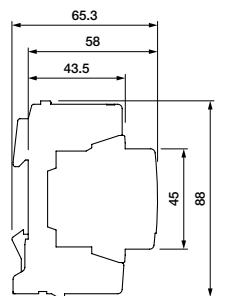

OVR T2 3L 40-440 P QS

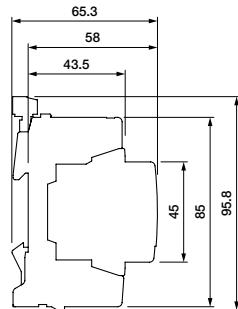

OVR T2 3L 40-440 P TS QS
OVR T2 3L 40-600 P TS QS

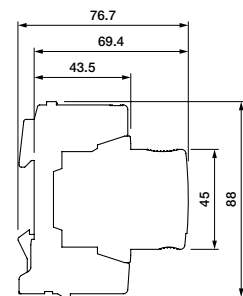

OVR T2 3L 80-440s P QS

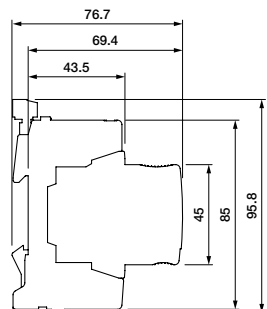

OVR T2 3L 80-440s P TS QS

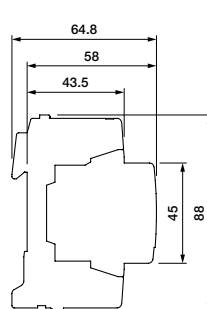

OVR T2 3L 40-400/690 P

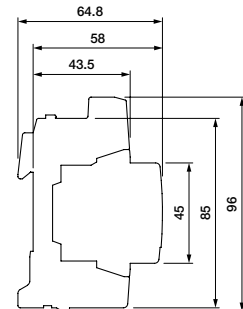

OVR T2 3L 40-400/690 P TS

Type	Width mm
OVR T2 3L 40-440 P QS	53.4
OVR T2 3L 40-440 P TS QS	53.4
OVR T2 3L 80-440s P QS	53.4
OVR T2 3L 80-440s P TS QS	53.4
OVR T2 3L 40-400/690 P	103.8
OVR T2 3L 40-400/690 P TS	106.8
OVR T2 3L 40-600 P TS QS	53.4

2CTC432008S0201

OVR Type 2 surge protective devices

TNC - 400 V networks

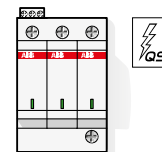
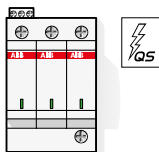

General technical data

Types	OVR T2 3L 40-440 P QS	OVR T2 3L 80-440s P QS	OVR T2 3L 40-400/690 P	-
with auxiliary contact (TS)	OVR T2 3L 40-440 P TS QS	OVR T2 3L 80-440s P TS QS	OVR T2 3L 40-400/690 P TS	OVR T2 3L 40-600 P TS QS
Electrical features				
Standard	IEC 61643-11 / EN 61643-11			
Type / test class	T2 / II	T2 / II	T2 / II	T2 / II
Protected lines	3	3	3	3
System network	TNC	TNC	TNC	TNC
Type of current	AC 45-65 Hz	AC 45-65 Hz	AC 47-63 Hz	AC 45-65 Hz
Voltage regulation of the system network	±10%	±50%	±10%	±50%
Nominal system voltage Un (L-PEN / L-L)	440 / 690 V	400 / 690 V	400 / 690 V	400 / 690 V
Max. cont. operating voltage Uc (L-PEN)	440 V	440 V	440 V	600 V
Nominal DC voltage Udc L-PE / Un DC L-L	495 / 990 V DC	495 / 990 V DC	-	650 / 990 V DC
Max. DC cont. operating voltage	545 / 1090 V DC	545 / 1090 V DC	-	715 / 1090 V DC
Ucdc L-PE / Ucdc L-L				
Maximum discharge current Imax (8/20)	40 kA	80 kA	40 kA	40 kA
Maximum impulse current Iimp (10/350)	2 kA	6.25 kA	2 kA	2 kA
Nominal discharge current In (8/20)	20 kA	30 kA	15 kA	20 kA
Voltage protection level Up at In	1.8 kV	2.4 kV	2.9 kV	2.3 kV
Voltage protection level Up at 3 kA	1.25 kV	1.25 kV	2.1 kV	1.6 kV
Voltage protection level Up at 5 kA	1.35 kV	1.35 kV	2.2 kV	1.7 kV
Voltage protection level Up at 10 kA	1.55 kV	1.55 kV	2.3 kV	1.9 kV
TOV (Temporary overvoltage) withstand Ut (L-N: 5s./N-PE: 200 ms)	581 V / -	581 V / -	910 V / -	792 V / -
Response time	< 25 ns	< 25 ns	< 25 ns	< 25 ns
Short-circuit withstand capability Isccr	100 kA	100 kA	100 kA	100 kA
Backup protection fuse (gG - gL) maximum rating	≤ 125 A	≤ 160 A	≤ 50 A	≤ 125 A
circuit breaker (B or C curve)	≤ 125 A	≤ 160 A	≤ 50 A	≤ 125 A
Pluggable cartridge	Yes	Yes	Yes	Yes
Integrated QuickSafe® technology	Yes	Yes	No	Yes
State indicator	Yes	Yes	Yes	Yes
Safety reserve	No	Yes	No	No
Auxiliary contact (TS)	Yes (TS option)	Yes (TS option)	Yes (TS option)	Yes
Installation				
Wire range (L, N, PE) solid wire	2.5...35 mm ²	2.5...35 mm ²	2.5...36 mm ²	2.5...36 mm ²
stranded wire	12.5 mm ²	12.5 mm ²	12.5 mm ²	12.5 mm ²
Stripping length (L, N, PE)	2.8 mm	2.8 mm	2.8 mm	2.8 mm
Tightening torque (L, N, PE)	-	-	-	-
Auxiliary contact (TS)				
Contacts information	1 NO - 1 NC	1 NO - 1 NC	1 NO - 1 NC	1 NO - 1 NC
Min. load	12 DC - 10 mA	12 DC - 10 mA	12 DC - 10 mA	12 DC - 10 mA
Max. load	250 V AC - 1 A	250 V AC - 1 A	250 V AC - 1 A	250 V AC - 1 A
Connection cross-section	1.5 mm ²	1.5 mm ²	1.5 mm ²	1.5 mm ²
Miscellaneous characteristics				
Stocking and operating temperature	-40...+80 °C	-40...+80 °C	-40...+80 °C	-40...+80 °C
Degree of protection	IP20	IP20	IP20	IP20
Fire resistance according to UL 94	V0	V0	V0	V0
Dimensions	mm h x w x d 88 x 53.4 x 65.3 mm inches h x w x d 3.46 x 2.1 x 2.57 in	mm h x w x d 88 x 53.4 x 76.7 mm inches h x w x d 3.46 x 2.1 x 3.02 in	mm h x w x d 88 x 53.4 x 64.8 mm inches h x w x d 3.46 x 2.1 x 2.55 in	-
Dimensions with auxiliary contact (TS)	mm h x w x d 95.8 x 53.4 x 65.3 mm inches h x w x d 3.77 x 2.1 x 2.57 in	mm h x w x d 95.8 x 53.4 x 76.7 mm inches h x w x d 3.77 x 2.1 x 3.02 in	mm h x w x d 96 x 53.4 x 64.8 mm inches h x w x d 3.78 x 2.1 x 2.55 in	mm h x w x d 95.8 x 53.4 x 65.3 mm inches h x w x d 3.77 x 2.1 x 2.57 in
Replacement cartridges				
Phase product ID	Type OVR T2 40-440 C QS Order code 2CTB803876R0400	Type OVR T2 80-440s C QS Order code 2CTB815708R5500	Type OVR T2 40-400/690 C Order code 2CTB803854R1100	Type OVR T2 40-600 C QS Order code 2CTB803886R0400
Neutral product ID	Type - Order -	Type - Order -	Type - Order -	Type - Order -

OVR Type 2 surge protective devices

TNS - 230 V networks

2



2CSC400300F013

OVR T2 4L 20-275



2CTC432389V0014

OVR T2 4L 40-275 P QS

Description

Type 2 surge protective devices are designed to protect electric installations and sensitive equipment against indirect surges with ensuring a low protection level (Up). They are characterized by their capacity to safely discharge current with 8/20 μs wave form.

Ordering details

Protected lines	Max. discharge current I _{max} 8/20 kA	Nominal discharge current I _n kA	Voltage protection level U _p kV	Nominal voltage U _n V	Max. cont. operating voltage U _c V	Bbn 3660308 EAN	Type	Order code	Weight Pkg (1 pce) kg
-----------------	---	---	--	----------------------------------	---	-----------------	------	------------	-----------------------

Type 2 unpluggable - U_c 275 V

4	20	5	1.0	230/400	275	519450	OVR T2 4L 20-275 (x5)	2CTB804600R1500	0.45
4	40	20	1.4	230/400	275	515988	OVR T2 4L 40-275	2CTB804601R0500	0.45
4	40	20	1.4	230/400	275	519474	OVR T2 4L 40-275 (x5)	2CTB804601R1500	0.45

Type 2 pluggable - U_c 275 V

4	40	20	1.25	230/400	275	20548	OVR T2 4L 40-275 P QS	2CTB803873R5600	0.45
4	40	20	1.25	230/400	275	20555	OVR T2 4L 40-275 P TS QS	2CTB803873R5200	0.45
4	40	20	1.5	230/400	275	25345	OVR T2 4L 40-275s P QS*	2CTB815704R2300	0.45
4	40	20	1.5	230/400	275	25284	OVR T2 4L 40-275s P TS QS*	2CTB815704R1100	0.45
4	80	30	1.8	230/400	275	25529	OVR T2 4L 80-275s P QS*	2CTB815708R2300	0.45
4	80	30	1.8	230/400	275	25468	OVR T2 4L 80-275s P TS QS*	2CTB815708R1100	0.45

* Products available end 2015.
(x5) packaging of 5 pieces.

Main dimensions mm

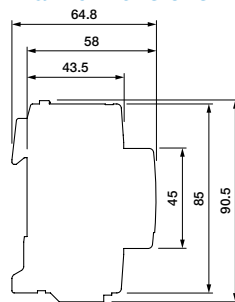

OVR T2 4L 20-275
OVR T2 4L 40-275

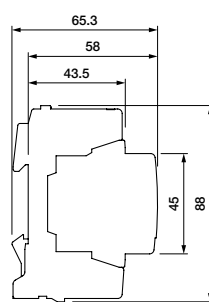

OVR T2 4L 40-275 P QS

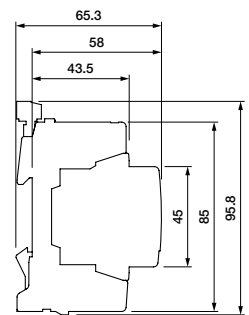

OVR T2 4L 40-275 P TS QS

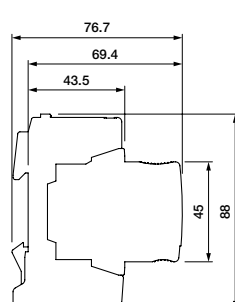

OVR T2 4L 40-275s P QS
OVR T2 4L 80-275s P QS

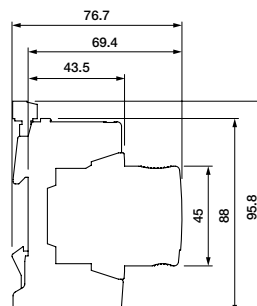

OVR T2 4L 40-275s P TS QS
OVR T2 4L 80-275s P TS QS

Type	Width mm
OVR T2 4L 40-275	71.2
OVR T2 4L 40-275 P QS	71.2
OVR T2 4L 40-275 P TS QS	71.2
OVR T2 4L 40-275s P QS	71.2
OVR T2 4L 40-275s P TS QS	71.2
OVR T2 4L 80-275s P QS	71.2
OVR T2 4L 80-275s P TS QS	71.2

OVR Type 2 surge protective devices

TNS - 230 V networks

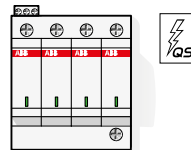
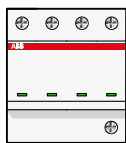

General technical data

Types	OVR T2 4L 20-275	OVR T2 4L 40-275	OVR T2 4L 40-275 P QS	OVR T2 4L 40-275s P QS	OVR T2 4L 80-275s P QS
with auxiliary contact (TS)	-	-	OVR T2 4L 40-275 P TS QS	OVR T2 4L 40-275s P TS QS	OVR T2 4L 80-275s P TS QS
Technology	Varistor	Varistor	Varistor	Varistor	Varistor
Electrical features					
Standard	IEC 61643-1 / EN 61643-11				
Type / test class	T2 / II	T2 / II	T2 / II	T2 / II	T2 / II
Protected lines	4	4	4	4	4
Types of networks	TNS	TNS	TNS	TNS	TNS
Type of current	AC	AC	AC	AC	AC
Nominal voltage Un (L-N/L-L)	230 / 400 V	230 / 400 V	230 / 400 V	230 / 400 V	230 / 400 V
Max. cont. operating AC voltage Uc	275 V	275 V	275 V	275 V	275 V
Nominal DC voltage Undc L-PE / Undc L-L	-	-	320 / 640 V DC	320 / 640 V DC	320 / 640 V DC
Max. DC cont. operating voltage Ucdc L-PE / Ucdc L-L	-	-	355 / 710 V DC	355 / 710 V DC	355 / 710 V DC
Maximum discharge current Imax (8/20)	20 kA	40 kA	40 kA	40 kA	80 kA
Maximum impulse current Iimp (10/350)	-	-	2 kA	2 kA	2 kA
Nominal discharge current In (8/20)	5 kA	20 kA	20 kA	20 kA	30 kA
Voltage protection level Up at In	1.0 kV	1.4 kV	1.25 kV	1.5 kV	1.8 kV
Voltage protection level Up at 3 kA	0.9 kV	0.9 kV	0.8 kV	0.5 kV	0.8 kV
Voltage protection level Up at 5 kA	-	-	-	0.7 kV	-
Voltage protection level Up at 10 kA	-	-	-	0.9 kV	-
TOV (Temporary overvoltage) withstand Ut (L-N: 5 s / N-PE: 200 ms)	334 V / -	334 V / -	334 V / -	337 V	334 V / -
Response time	≤ 25 ns	≤ 25 ns	≤ 25 ns	≤ 25 ns	≤ 25 ns
Residual current IPE	100 µA	100 µA	100 µA (200 for s option)	-	200 µA
Short-circuit withstand capability Isccr	50 kA	50 kA	100 kA	100 kA	100 kA
Backup protection	Fuse (gG - gL) Circuit breaker (B or C curve)	≤ 50 A ≤ 50 A	≤ 125 A ≤ 125 A	≤ 160 A ≤ 125 A	≤ 160 A ≤ 125 A
Pluggable cartridge	No	No	Yes	Yes	Yes
Integrated thermal disconnect	Yes	Yes	Yes	Yes	Yes
State indicator	Yes	Yes	Yes	Yes	Yes
Safety reserve	No	No	No	Yes	Yes
Auxiliary contact (TS)	No	No	Yes (TS option)	Yes (TS option)	Yes (TS option)
Installation					
Wire range (L, N, PE)	Solid wire Stranded wire	2.5...25 mm ² 2.5...16 mm ²	2.5...25 mm ² 2.5...16 mm ²	2.5...25 mm ² 2.5...16 mm ²	2.5...25 mm ² 2.5...16 mm ²
Stripping length (L, N, PE)		12.5 mm	12.5 mm	12.5 mm	12.5 mm
Tightening torque (L, N, PE)		2.5 Nm	2.5 Nm	2.5 Nm	2.5 Nm
Auxiliary contact (TS)					
Contact complement	-	-	1 NO - 1 NC	-	1 NO - 1 NC
Minimum load	-	-	12 V DC - 10 mA	-	12 V DC - 10 mA
Maximum load	-	-	250 V AC - 1 A	-	250 V AC - 1 A
Connection cross-section	-	-	1.5 mm ²	-	1.5 mm ²
Miscellaneous characteristics					
Stocking and operating temperature	-40...+80 °C	-40...+80 °C	-40...+80 °C	-40...+80 °C	-40...+80 °C
Degree of protection	IP20	IP20	IP20	IP20	IP20
Fire resistance according to UL 94	V0	V0	V0	V0	V0
Dimensions	mm inches	h x w x d 90.5 x 71.2 x 64.8 mm 3.56 x 2.8 x 2.55 in	h x w x d 90.5 x 71.2 x 64.8 mm 3.56 x 2.8 x 2.55 in	h x w x d 88 x 71.2 x 65.3 mm 3.46 x 2.8 x 2.57 in	h x w x d 88 x 71.2 x 76.7 mm 3.46 x 2.8 x 3.02 in
Dimensions with auxiliary contact (TS)	mm inches	h x w x d - -	h x w x d - -	h x w x d 95.8 x 71.2 x 65.3 mm 3.77 x 2.8 x 2.57 in	h x w x d 95.8 x 71.2 x 76.7 mm 3.77 x 2.8 x 3.02 in
Replacement cartridges					
Phase product ID	Type	-	-	OVR T2 40-275 C QS	OVR T2 40-275s C QS
	Order code	-	-	2CTB803876R1000	2CTB8157084R2600
Neutral product ID	Type	-	-	-	-
	Order	-	-	-	2CTB815708R2600

OVR Type 2 surge protective devices TNS - 400 V networks

2

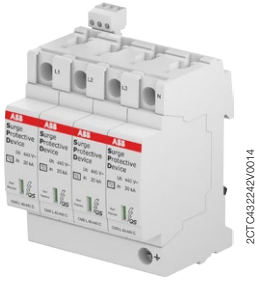

OVR T2 4L 40-275 P QS

Description

Type 2 surge protective devices are designed to protect electric installations and sensitive equipment against indirect surges with ensuring a low protection level (Up). They are characterized by their capacity to safely discharge current with 8/20 μ s wave form.

Ordering details

Protected lines	Max. discharge current I _{max} 8/20 kA	Nominal discharge current I _n kA	Voltage protection level Up kV	Max. cont. operating voltage Uc V	Bbn 3660308 EAN	Type	Order code	Weight Pkg (1 pce) kg
-----------------	---	---	--------------------------------	-----------------------------------	-----------------	------	------------	-----------------------

Type 2 pluggable

4	40	20	1.8	440	519894	OVR T2 4L 40-440 P QS	2CTB803873R5100	0.45
4	40	20	1.8	440	519900	OVR T2 4L 40-440 P TS QS	2CTB803873R5300	0.45
4	40	20	2.3	600	520685	OVR T2 4L 40-600 P TS QS	2CTB803883R5300	0.45
4	80	30	2.4	440	525635	OVR T2 4L 80-440s P QS*	2CTB815708R5200	0.45
4	80	30	2.4	440	525598	OVR T2 4L 80-440s P TS QS*	2CTB815708R4000	0.45

* Products available end 2015.

Main dimensions mm

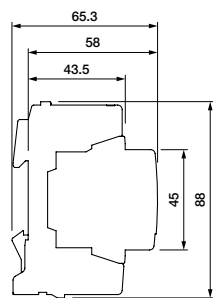

OVR T2 4L 40-440 P QS

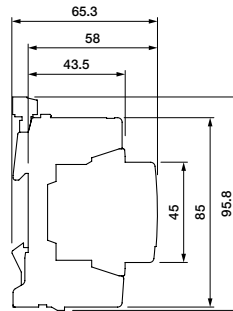

OVR T2 4L 40-440 P TS QS
OVR T2 4L 40-600 P TS QS

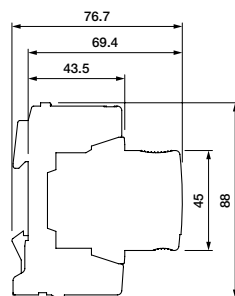

OVR T2 4L 80-440s P QS

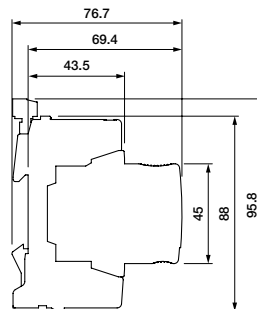

OVR T2 4L 80-440s P TS QS

Type	Width mm
OVR T2 4L 40-440 P QS	71.2
OVR T2 4L 40-440 P TS QS	71.2
OVR T2 4L 40-600 P TS QS	71.2
OVR T2 4L 80-440s P QS	71.2
OVR T2 4L 80-440s P TS QS	71.2

2CTC432242V0014

OVR Type 2 surge protective devices TNS - 400 V networks

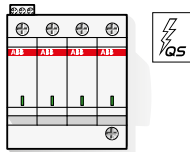

General technical data

Types	OVR T2 4L 40-440 P QS	-	OVR T2 4L 80-440s P QS
with auxiliary contact (TS)	OVR T2 4L 40-440 P TS QS	OVR T2 4L 40-600 P TS QS	OVR T2 4L 80-440s P TS QS
Electrical features			
Standard	IEC 61643-11 / EN 61643-11		
Type / test class	T2 / II	T2 / II	T2 / II
Protected lines	4	4	4
System network	TNS	TNS	TNS
Type of current	AC	AC	AC
Voltage regulation of the system network	±10%	±50%	±10%
Nominal system voltage Un (L-N/ L-L)	400 / 690 V	400 / 690 V	400 / 690 V
Max. cont. operating AC voltage Uc	440 V	600 V	440 V
Nominal DC voltage Undc L-PE / Undc L-L	495 / 990 V	650 / 990 V	495 / 990 V
Max. DC cont. operating voltage Ucdc L-PE / Ucdc L-L	545 / 1090 V	715 / 1090 V	545 / 1090 V
Nominal DC voltage Undc L-PE / Undc L-L	495 / 990 V	495 / 990 V	495 / 990 V
Max. DC cont. operating voltage Ucdc L-PE / Ucdc L-L	545 / 1090 V	545 / 1090 V	545 / 1090 V
Maximal discharge current I _{max} (8/20)	40 kA	40 kA	80 kA
Maximum impulse current I _{imp} (10/350)	2 kA	2 kA	2 kA
Nominal discharge current I _n (8/20)	20 kA	20 kA	30 kA
Follow current interrupting rating I _{fi}	-	-	-
Voltage protection level Up at In	1.8 kV	2.3 kV	2.4 kV
Voltage protection level Up at 3 kA	1.25 kV	1.6 kV	0.8 kV
Voltage protection level Up at 5 kA	1.35 kV	1.7 kV	1.2 kV
Voltage protection level Up at 10 kA	1.55 kV	1.9 kV	1.5 kV
TOV (Temporary overvoltage) withstand Ut (L-N: 5s./N-PE: 200ms)	581 V / -	792 V / -	581 V / -
Response time	≤ 25 ns	≤ 25 ns	≤ 25 ns
Short-circuit withstand capability I _{scrr}	100 kA	100 kA	100 kA
Backup protection	Fuse (gG - gL)	≤ 125 A	≤ 160 A
maximum rating	Circuit breaker (B or C curve)	≤ 125 A	≤ 125 A
Pluggable cartridge	Yes	Yes	Yes
Integrated thermal disconnecter	Yes	Yes	Yes
State indicator	Yes	Yes	Yes
Safety reserve	No	No	Yes
Auxiliary contact (TS)	Yes (TS option)	Yes	Yes (TS option)
Installation			
Wire range (L, N, PE)	solid wire	2.5...25 mm ²	2.5...35 mm ²
	stranded wire	2.5...16 mm ²	2.5...25 mm ²
Stripping length (L, N, PE)		12.5 mm	12.5 mm
Tightening torque (L, N, PE)		2.5 Nm	2.5 Nm
Auxiliary contact (TS)			
Contacts information	1 NO - 1 NC	1 NO - 1 NC	1 NO - 1 NC
Min. load	12 V DC - 10 mA	12 V DC - 10 mA	12 V DC - 10 mA
Max. load	250 V AC - 1 A	250 V AC - 1 A	250 V AC - 1 A
Connection cross-section	1.5 mm ²	1.5 mm ²	1.5 mm ²
Miscellaneous characteristics			
Stocking and operating temperature	-40...+80 °C	-40...+80 °C	-40...+80 °C
Degree of protection	IP20	IP20	IP20
Fire resistance according to UL 94	V0	V0	V0
Dimensions	mm	h x w x d	88 x 71.2 x 65.3 mm
	inches	h x w x d	3.46 x 2.8 x 2.57 in
Dimensions	mm	h x w x d	95.8 x 142.4 x 69 mm
with auxiliary contact (TS)	inches	h x w x d	3.77 x 2.8 x 2.57 in
Replacement cartridges			
Phase product ID	Type	OVR T2 40-440 C QS	OVR T2 40-600 C QS
	Order code	2CTB803876R0400	2CTB803886R0400
			OVR T2 80-440s C QS
			2CTB815708R5500

OVR Type 2 surge protective devices TNS - TT - 230 V - 1Ph+N networks

2



2CTC43219V0014

OVR T2 1N 40-275 P QS

Description

Type 2 surge protective devices are designed to protect electric installations and sensitive equipment against indirect surges with ensuring a low protection level (Up). They are characterized by their capacity to safely discharge current with 8/20 µs wave form.

Ordering details

Pro- tected lines	Im pulse current limp 10/350 kA	Max. dis- charge current Imax 8/20 kA	Nominal current In kA	Voltage protec- tion level Up kV	Nominal voltage Un V	Max. cont. operating voltage Uc V	Bbn 3660308 EAN	Type	Order code	Weight Pkg (1 pce) kg
-------------------------	--	---	--------------------------------	---	-------------------------------	--	-----------------------	------	------------	--------------------------------

Type 2 pluggable - Uc 275 V

1+1	2	40	20	1.5	230	275	519696	OVR T2 1N 40-275 P QS	2CTB803972R1100	0.24
1+1	2	40	20	1.5	230	275	519702	OVR T2 1N 40-275 P TS QS	2CTB803972R0500	0.24
1+1	2	40	20	1.5	230	275	525307	OVR T2 1N 40-275s P QS*	2CTB815704R1400	0.30
1+1	2	40	20	1.5	230	275	525239	OVR T2 1N 40-275s P TS QS*	2CTB815704R0200	0.30
1+1	2	80	30	1.8	230	275	525482	OVR T2 1N 80-275s P QS*	2CTB815708R1400	0.30
1+1	2	80	30	1.8	230	275	525413	OVR T2 1N 80-275s P TS QS*	2CTB815708R0200	0.30
1+1	2	40	20	1.7	230	350	519719	OVR T2 1N 40-350 P QS	2CTB803982R1100	0.24
1+1	2	40	20	1.7	230	350	519726	OVR T2 1N 40-350 P TS QS	2CTB803982R0500	0.24

* Products available end 2015.

Main dimensions mm

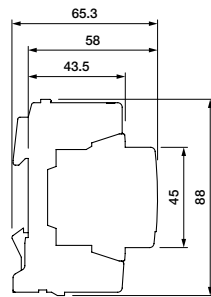

OVR T2 1N 40-275 P QS
OVR T2 1N 40-350 P QS

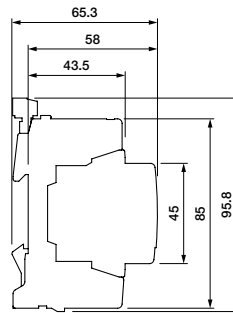

OVR T2 1N 40-275 P TS QS
OVR T2 1N 40-350 P TS QS

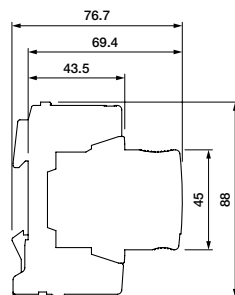

OVR T2 1N 40-275s P QS
OVR T2 1N 80-275s P QS

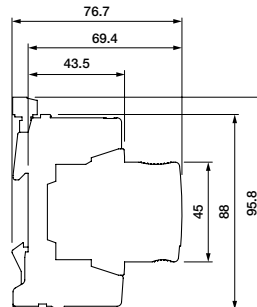

OVR T2 1N 40-275s P TS QS
OVR T2 1N 80-275s P TS QS

Type	Width mm
OVR T2 1N 40-275 P QS	35.6
OVR T2 1N 40-275 P TS QS	35.6
OVR T2 1N 40-275s P QS*	35.6
OVR T2 1N 40-275s P TS QS*	35.6
OVR T2 1N 80-275s P QS*	35.6
OVR T2 1N 80-275s P TS QS*	35.6
OVR T2 1N 40-350 P QS	35.6
OVR T2 1N 40-350 P TS QS	35.6

OVR Type 2 surge protective devices

TNS - TT - 230 V - 1Ph+N networks

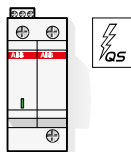

General technical data

Types	OVR T2 1N 40-275 P QS	OVR T2 1N 40-275s P QS	OVR T2 1N 80-275s P QS	OVR T2 1N 40-350 P QS
with auxiliary contact (TS)	OVR T2 1N 40-275 P TS QS	OVR T2 1N 40-275s P TS QS	OVR T2 1N 80-275s P TS QS	OVR T2 1N 40-350 P TS QS
Electrical features				
Standard	IEC 61643-11 / EN 61643-11			
Type / test class	T2 / II	T2 / II	T2 / II	T2 / II
Protected lines	1+1	1+1	1+1	1+1
System network	TNS - TT	TNS - TT	TNS - TT	TNS - TT
Type of current	AC 45-65 Hz	AC 45-65 Hz	AC 45-65 Hz	AC 45-65 Hz
Voltage regulation of the system network	±20%	±20%	±20%	±50%
Nominal system voltage Un	230 V	230 V	230 V	230 V
Max. cont. operating voltage Uc	275 V	275 V	275 V	350 V
Maximum discharge current Imax (8/20)	40 kA	40 kA	80 kA	40 kA
Maximum impulse current Iimp (10/350)	2 kA	2 kA	6.25 kA	2 kA
Nominal discharge current In (8/20)	20 kA	20 kA	30 kA	20 kA
Total Current	80 kA	80 kA	160 kA	80 kA
Voltage protection level Up at In (L-N / N-PE / L-PE)	1.25 / 1.4 / 1.5 kV	1.25 / 1.4 / 1.5 kV	1.6 / 1 / 1.8 kV	1.5 / 1.4 / 1.7 kV
Voltage protection level Up at 3 kA (L-N / N-PE / L-PE)	0.8 / 1.4 / 0.85 kV	0.8 / 1.4 / 0.85 kV	0.8 / 1.4 / 0.85 kV	1.0 / 1.4 / 1.05 kV
Voltage protection level Up at 5 kA (L-N / N-PE / L-PE)	0.85 / 1.4 / 0.95 kV	0.85 / 1.4 / 0.95 kV	0.85 / 1.4 / 0.95 kV	1.05 / 1.4 / 1.1 kV
Voltage protection level Up at 10 kA (L-N / N-PE / L-PE)	1 / 1.4 / 1.15 kV	1 / 1.4 / 1.15 kV	1 / 1.4 / 1.15 kV	1.2 / 1.4 / 1.3 kV
TOV (Temporary overvoltage) withstand Ut (L-N: 5s./N-PE: 200 ms)	337 / 1200 V	337 / 1200 V	337 / 1200 V	455 / 1200 V
Uoc	-	-	-	-
Response time	< 25 ns	< 25 ns	< 25 ns	< 25 ns
Short-circuit withstand capability Isccr	100 kA	100 kA	100 kA	100 kA
Backup protection fuse (gG - gL) maximum rating	≤ 125 A	≤ 160 A	≤ 160 A	≤ 125 A
circuit breaker (B or C curve)	≤ 125 A	≤ 125 A	≤ 125 A	≤ 125 A
Pluggable cartridge	Yes	Yes	Yes	Yes
Integrated QuickSafe® technology	Yes	Yes	Yes	Yes
State indicator	Yes	Yes	Yes	Yes
Safety reserve	No	Yes	Yes	No
Auxiliary contact (TS)	Yes (TS option)	Yes (TS option)	Yes (TS option)	Yes (TS option)
Installation				
Wire range (L, N, PE) solid wire	2.5...25 mm ²	2.5...25 mm ²	2.5...25 mm ²	2.5...25 mm ²
stranded wire	2.5...16 mm ²	2.5...35 mm ²	2.5...35 mm ²	2.5...16 mm ²
Stripping length (L, N, PE)	12.5 mm	12.5 mm	12.5 mm	12.5 mm
Tightening torque (L, N, PE)	2.8 Nm	2.8 Nm	2.8 Nm	2.8 Nm
Auxiliary contact (TS)				
Contacts information	1 NO - 1 NC	1 NO - 1 NC	1 NO - 1 NC	1 NO - 1 NC
Min. load	12 V DC - 10 mA	12 V DC - 10 mA	12 V DC - 10 mA	12 V DC - 10 mA
Max. load	250 V AC - 1 A	250 V AC - 1 A	250 V AC - 1 A	250 V AC - 1 A
Connection cross-section	1.5 mm ²	1.5 mm ²	1.5 mm ²	1.5 mm ²
Miscellaneous characteristics				
Stocking and operating temperature	-40...+80 °C	-40...+80 °C	-40...+80 °C	-40...+80 °C
Degree of protection	IP20	IP20	IP20	IP20
Fire resistance according to UL 94	V0	V0	V0	V0
Dimensions mm	h x w x d 88 x 35.6 x 65.3 mm	88 x 35.6 x 76.7 mm	88 x 35.6 x 76.7 mm	88 x 35.6 x 65.3 mm
inches	h x w x d 3.46 x 1.4 x 2.57 in	3.46 x 1.4 x 3.02 in	3.46 x 1.4 x 3.02 in	3.46 x 1.4 x 2.57 in
Dimensions with auxiliary contact (TS) mm	h x w x d 95.8 x 35.6 x 65.3 mm	95.8 x 35.6 x 76.7 mm	95.8 x 35.6 x 76.7 mm	95.8 x 35.6 x 65.3 mm
inches	h x w x d 3.77 x 1.4 x 2.57 in	3.77 x 1.4 x 3.02 in	3.77 x 1.4 x 3.02 in	3.77 x 1.4 x 2.57 in
Replacement cartridges				
Phase product ID Type	OVR T2 40-275 C QS	OVR T2 40-275s C QS	OVR T2 80-275s C QS	OVR T2 40-350 C QS
Order code	2CTB803876R1000	2CTB815704R2600	2CTB815708R2600	2CTB803886R1000
Neutral product ID Type	OVR T2 N 80-275 C QS	OVR T2 N 80-275s C QS	OVR T2 N 80-275s C QS	OVR T2 N 80-350 C QS
Order code	2CTB803876R0000	2CTB815708R2800	2CTB815708R2800	2CTB803886R0000

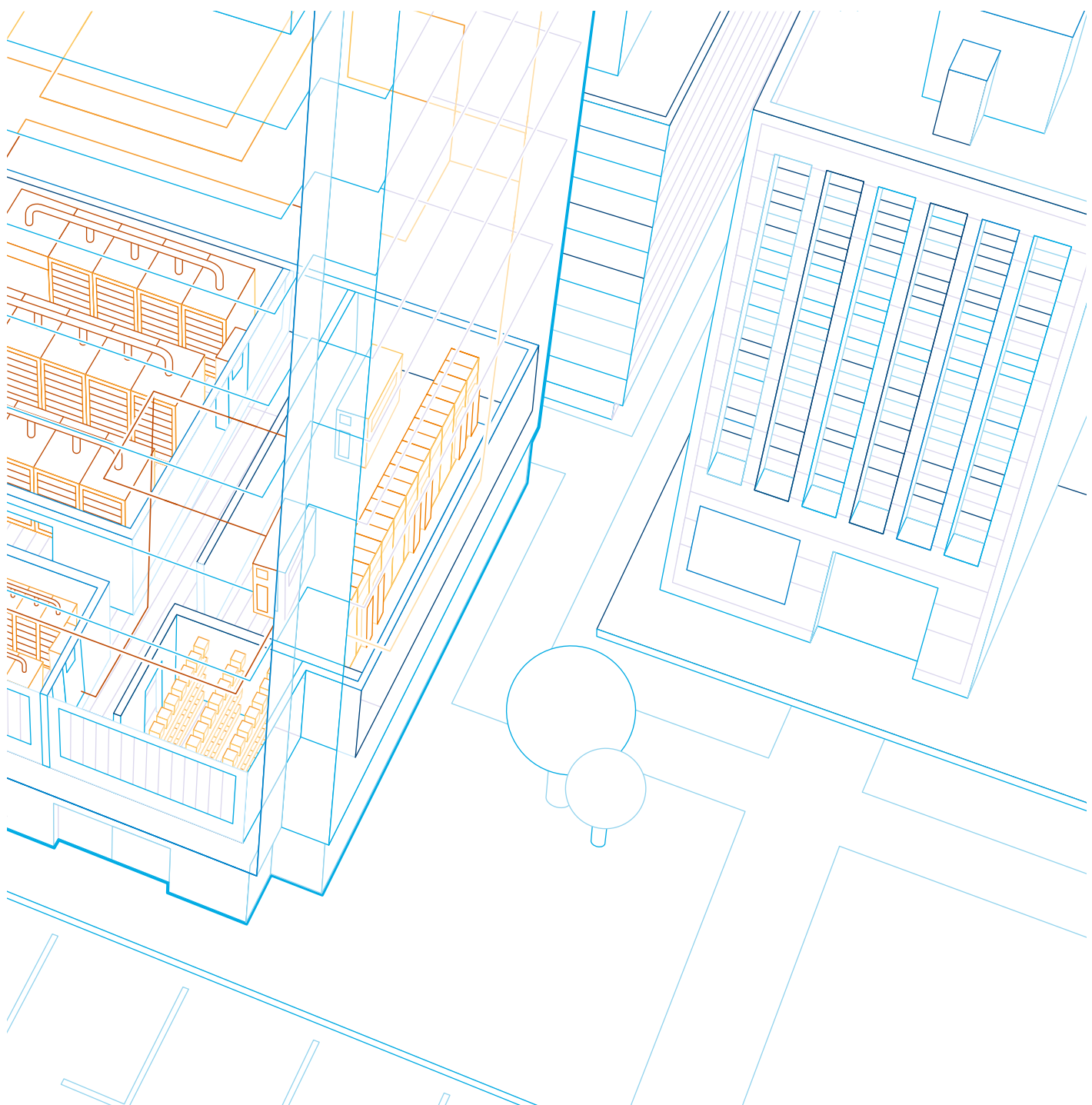

OVR Type 2 surge protective devices

TNS - TT - 230 and 400 V - 3Ph+N networks



OVR T2 3N 40-275 P QS

Description

Type 2 surge protective devices are designed to protect electric installations and sensitive equipment against indirect surges with ensuring a low protection level (Up). They are characterized by their capacity to safely discharge current with 8/20 μ s wave form.

Ordering details

Max. discharge current I_{max} 8/20 kA	Nominal discharge current I_n kA	Voltage protection level U_p kV	Nominal voltage U_n V	Max. cont. operating voltage U_c V	Bbn 3660308 EAN	Type	Order code	Weight Pkg (1 pce) kg
---	--	---	-------------------------------	--	-----------------------	------	------------	--------------------------------

Type 2 pluggable - U_c 275 V

40	20	1.5	230/400	275	519931	OVR T2 3N 40-275 P QS	2CTB803973R1100	0.48
40	20	1.5	230/400	275	519948	OVR T2 3N 40-275 P TS QS	2CTB803973R0500	0.48
40	20	1.5	230/400	275	525321	OVR T2 3N 40-275s P QS*	2CTB815704R2000	0.60
40	20	1.5	230/400	275	525260	OVR T2 3N 40-275s P TS QS*	2CTB815704R0800	0.60
80	30	1.8	230/400	275	525505	OVR T2 3N 80-275s P QS*	2CTB815708R2000	0.60
80	30	1.8	230/400	275	525444	OVR T2 3N 80-275s P TS QS*	2CTB815708R0800	0.60
40	20	1.7	230/400	350	519962	OVR T2 3N 40-350 P QS	2CTB803983R1100	0.48
40	20	1.7	230/400	350	519979	OVR T2 3N 40-350 P TS QS	2CTB803983R0500	0.48
40	20	2.1	400/690	440	519993	OVR T2 3N 40-440 P QS	2CTB803973R1400	0.48
40	20	2.1	400/690	440	520005	OVR T2 3N 40-440 P TS QS	2CTB803973R1500	0.48
40	20	2.1	400/690	440	525376	OVR T2 3N 40-440s P TS QS*	2CTB815704R3700	1.05
80	30	2.4	400/690	440	525628	OVR T2 3N 80-440s P QS*	2CTB815708R4900	1.05
80	30	2.4	400/690	440	525581	OVR T2 3N 80-440s P TS QS*	2CTB815708R3700	1.05

* Products available end 2015.

Main dimensions mm

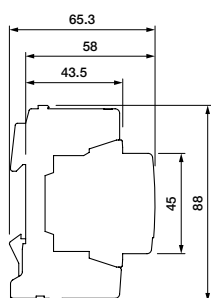

OVR T2 3N 40-275 P QS
OVR T2 3N 40-350 P QS
OVR T2 3N 40-440 P QS

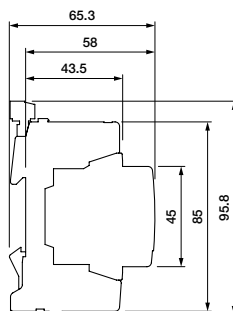

OVR T2 3N 40-275 P TS QS
OVR T2 3N 40-350 P TS QS
OVR T2 3N 40-440 P TS QS

Type	Width mm
OVR T2 3N 40-275 P QS	71.2
OVR T2 3N 40-275 P TS QS	71.2
OVR T2 3N 40-275s P QS	71.2
OVR T2 3N 40-275s P TS QS	71.2
OVR T2 3N 80-275s P QS	71.2
OVR T2 3N 80-275s P TS QS	71.2
OVR T2 3N 40-350 P QS	71.2
OVR T2 3N 40-350 P TS QS	71.2
OVR T2 3N 40-440 P QS	71.2
OVR T2 3N 40-440 P TS QS	71.2
OVR T2 3N 40-440s P TS QS	71.2
OVR T2 3N 80-440s P QS	71.2
OVR T2 3N 80-440s P TS QS	71.2

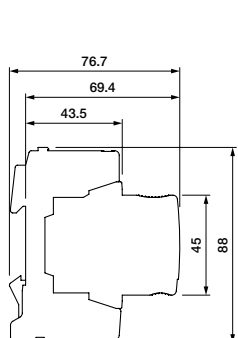

OVR T2 3N 40-275s P QS
OVR T2 3N 80-275s P QS
OVR T2 3N 80-440s P QS

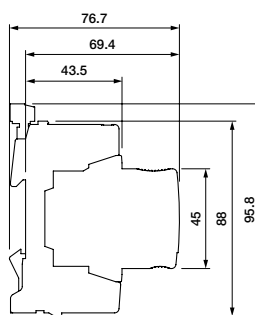

OVR T2 3N 40-275s P TS QS
OVR T2 3N 80-275s P TS QS
OVR T2 3N 40-440s P TS QS
OVR T2 3N 80-440s P TS QS

OVR Type 2 surge protective devices

TNS - TT - 230 and 400 V - 3Ph+N networks

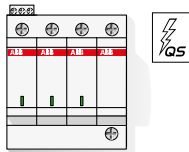

2

General technical data

Types	OVR T2 3N 40-275 P QS	OVR T2 3N 40-275s P QS	OVR T2 3N 80-275s P QS
with auxiliary contact (TS)	OVR T2 3N 40-275 P TS QS	OVR T2 3N 40-275s P TS QS	OVR T2 3N 80-275s P TS QS
Electrical features			
Standard	IEC 61643-11 / EN 61643-11		
Type / test class	T2 / II	T2 / II	T2 / II
Protected lines	3+1	3+1	3+1
System network	TNS - TT	TNS - TT	TNS - TT
Type of current	AC 45-65 Hz	AC 45-65 Hz	AC 45-65 Hz
Voltage regulation of the system network	±20%	±20%	0
Nominal system voltage Un (L-N / L-L)	230 / 400 V	230 / 400 V	230 / 400 V
Max. cont. operating voltage Uc (L-N / L-L)	275 V	275 V	275 V
Maximum discharge current I _{max} (8/20)	40 kA	40 kA	80 kA
Maximum impulse current I _{imp} (10/350)	2 kA	2 kA	6.25 kA
Nominal discharge current I _n (8/20)	20 kA	20 kA	30 kA
Total Current	160 kA	160 kA	240 kA
Voltage protection level Up at I _n (L-N / N-PE / L-PE)	1.25 / 1.4 / 1.5 kV	1.25 / 1.4 / 1.5 kV	1.6 / 1 / 1.8 kV
Voltage protection level Up at 3 kA (L-N / N-PE / L-PE)	0.8 / 1.4 / 0.85 kV	0.8 / 1.4 / 0.85 kV	0.8 / 1.4 / 0.85 kV
Voltage protection level Up at 5 kA (L-N / N-PE / L-PE)	0.85 / 1.4 / 0.95 kV	0.85 / 1.4 / 0.95 kV	0.85 / 1.4 / 0.95 kV
Voltage protection level Up at 10 kA (L-N / N-PE / L-PE)	1 / 1.4 / 1.15 kV	1 / 1.4 / 1.15 kV	1 / 1.4 / 1.15 kV
TOV (Temporary overvoltage) withstand Ut (L-N: 5s./N-PE: 200 ms)	337 / 1200 V	337 / 1200 V	337 / 1200 V
Response time	< 25 ns	< 25 ns	< 25 ns
Short-circuit withstand capability I _{sc} cr	100 kA	100 kA	100 kA
Backup protection fuse (gG - gL)	≤ 125 A	≤ 160 A	≤ 160 A
maximum rating circuit breaker (B or C curve)	≤ 125 A	≤ 125 A	≤ 125 A
Pluggable cartridge	Yes	Yes	Yes
Integrated QuickSafe® technology	Yes	Yes	Yes
State indicator	Yes	Yes	Yes
Safety reserve	No	Yes	Yes
Auxiliary contact (TS)	Yes (TS option)	Yes (TS option)	Yes (TS option)
Installation			
Wire range (L, N, PE)	solid wire 2.5...25 mm ² stranded wire 2.5...16 mm ²	2.5...25 mm ² 2.5...35 mm ²	2.5...25 mm ² 2.5...35 mm ²
Stripping length (L, N, PE)	12.5 mm	12.5 mm	12.5 mm
Tightening torque (L, N, PE)	2.8 mm	2.8 mm	2.8 mm
Auxiliary contact (TS)			
Contacts information	1 NO - 1 NC	1 NO - 1 NC	1 NO - 1 NC
Min. load	12 V DC - 10 mA	12 V DC - 10 mA	12 V DC - 10 mA
Max. load	250 V AC - 1 A	250 V AC - 1 A	250 V AC - 1 A
Connection cross-section	1.5 mm ²	1.5 mm ²	1.5 mm ²
Miscellaneous characteristics			
Stocking and operating temperature	-40...+80 °C	-40...+80 °C	-40...+80 °C
Degree of protection	IP20	IP20	IP20
Fire resistance according to UL 94	V0	V0	V0
Dimensions	mm <i>h x w x d</i> 88 x 71.2 x 65.3 mm	mm <i>h x w x d</i> 88 x 71.2 x 76.7 mm	mm <i>h x w x d</i> 88 x 71.2 x 76.7 mm
	inches <i>h x w x d</i> 3.46 x 2.8 x 2.57 in	inches <i>h x w x d</i> 3.46 x 2.8 x 3.02 in	inches <i>h x w x d</i> 3.46 x 2.8 x 3.02 in
Dimensions with auxiliary contact (TS)	mm <i>h x w x d</i> 95.8 x 71.2 x 65.3 mm	mm <i>h x w x d</i> 95.8 x 71.2 x 76.7 mm	mm <i>h x w x d</i> 95.8 x 71.2 x 76.7 mm
	inches <i>h x w x d</i> 3.77 x 2.8 x 2.57 in	inches <i>h x w x d</i> 3.77 x 2.8 x 3.02 in	inches <i>h x w x d</i> 3.77 x 2.8 x 3.02 in
Replacement cartridges			
Phase product ID	Type OVR T2 40-275 C QS	Type OVR T2 40-275s C QS	Type OVR T2 80-275s C QS
	Order code 2CTB803876R1000	Order code 2CTB815704R2600	Order code 2CTB815708R2600
Neutral product ID	Type OVR T2 N 80-275 C QS	Type OVR T2 N 80-275s C QS	Type OVR T2 N 80-275s C QS
	Order code 2CTB803876R0000	Order code 2CTB815708R2800	Order code 2CTB815708R2800

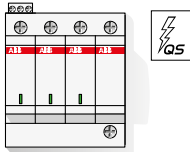

OVR T2 3N 40-350 P QS	OVR T2 3N 40-440 P QS	-	OVR T2 3N 80-440s P QS
OVR T2 3N 40-350 P TS QS	OVR T2 3N 40-440 P TS QS	OVR T2 3N 40-440s P TS QS	OVR T2 3N 80-440s P TS QS
IEC 61643-11 / EN 61643-11			
T2 / II	T2 / II	T2 / II	T2 / II
3+1	3+1	3+1	3+1
TNS - TT	TNS - TT	TNS - TT	TNS - TT
AC 45-65 Hz	AC 45-65 Hz	AC 45-65 Hz	AC 45-65 Hz
±50%	±10%	±10%	0
230 / 400 V	400 / 690 V	400 / 690 V	400 / 690 V
350 V	440 V	440 V	440 V
40 kA	40 kA	40 kA	80 kA
2 kA	2 kA	2 kA	6.25 kA
20 kA	20 kA	20 kA	30 kA
160 kA	160 kA	160 kA	160 kA
1.5 / 1.4 / 1.7 kV	1.8 / 1.4 / 2.1 kV	1.8 / 1.4 / 2.1 kV	2.1 / 1 / 2.4 kV
1.0 / 1.4 / 1.05 kV	1.25 / 1.4 / 1.45 kV	1.25 / 1.4 / 1.45 kV	1.25 / 1.4 / 1.45 kV
1.05 / 1.4 / 1.1 kV	1.35 / 1.4 / 1.45 kV	1.35 / 1.4 / 1.45 kV	1.35 / 1.4 / 1.45 kV
1.2 / 1.4 / 1.3 kV	1.55 / 1.4 / 1.65 kV	1.55 / 1.4 / 1.65 kV	1.55 / 1.4 / 1.65 kV
455 / 1200 V	581 / 1200 V	581 / 1200 V	581 / 1200 V
< 25 ns	< 25 ns	< 26 ns	< 25 ns
100 kA	100 kA	100 kA	100 kA
≤ 125 A	≤ 125 A	≤ 160 A	≤ 160 A
≤ 125 A	≤ 125 A	≤ 125 A	≤ 125 A
Yes	Yes	Yes	Yes
Yes	Yes	Yes	Yes
Yes	Yes	Yes	Yes
No	No	Yes	Yes
Yes (TS option)	Yes (TS option)	Yes	Yes (TS option)
2.5...25 mm ²	2.5...25 mm ²	2.5...25 mm ²	2.5...25 mm ²
2.5...16 mm ²	2.5...16 mm ²	2.5...35 mm ²	2.5...35 mm ²
12.5 mm	12.5 mm	12.5 mm	12.5 mm
2.8 mm	2.8 mm	2.8 mm	2.8 mm
1 NO - 1 NC	1 NO - 1 NC	1 NO - 1 NC	1 NO - 1 NC
12 V DC - 10 mA	12 V DC - 10 mA	12 V DC - 10 mA	12 V DC - 10 mA
250 V AC - 1 A	250 V AC - 1 A	250 V AC - 1 A	250 V AC - 1 A
1.5 mm ²	1.5 mm ²	1.5 mm ²	1.5 mm ²
-40...+80 °C	-40...+80 °C	-40...+80 °C	-40...+80 °C
IP20	IP20	IP20	IP20
V0	V0	V0	V0
88 x 71.2 x 65.3 mm	88 x 71.2 x 65.3 mm	-	88 x 71.2 x 76.7 mm
3.46 x 2.8 x 2.57 in	3.46 x 2.8 x 2.57 in	-	3.46 x 2.8 x 3.02 in
95.8 x 71.2 x 65.3 mm	95.8 x 71.2 x 65.3 mm	95.8 x 71.2 x 76.7 mm	95.8 x 71.2 x 76.7 mm
3.77 x 2.8 x 2.57 in	3.77 x 2.8 x 2.57 in	3.77 x 2.8 x 3.02 in	3.77 x 2.8 x 3.02 in
OVR T2 40-350 C QS	OVR T2 40-440 C QS	OVR T2 40-440s C QS	OVR T2 80-440s C QS
2CTB803886R1000	2CTB803876R0400	2CTB815704R5500	2CTB815708R5500
OVR T2 N 80-350 C QS	OVR T2 N 80-440 C QS	OVR T2 N 80-440s C QS	OVR T2 N 80-440s C QS
2CTB803886R0000	2CTB803886R0100	2CTB815708R5700	2CTB815708R5700

OVR Type 2-3 surge protective devices - Single pole 230 and 400 V networks

2



OVR T2 T3 20- 275 P QS

Description

Type 2 and 3 surge protective devices shall be installed as close as possible to the sensitive equipment to protect. As Type 2 they have been characterized by their capacity to safely discharge current with a 8/20 μ s wave form and they guarantee the coordination with Type 1 SPDs or other Type 2 respecting coordination distances. As Type 3 they are characterized by their capacity to safely discharge current with 1.2/50 μ s wave form, with a very low level of voltage protection level.

Ordering details

Protected lines	Max. discharge current I_{max} 8/20 kA	Nominal discharge current I_n kA	Voltage protection level U_p kV	Nominal voltage U_n V	Max. cont. operating voltage U_c V	Bbn 3660308 EAN	Type	Order code	Weight Pkg (1 pce) kg
-----------------	---	--	---	-------------------------------	--	-----------------------	------	------------	--------------------------------

Pluggable

1	20	5	0.9	230	275	519566	OVR T2-T3 20-275 P QS	2CTB803871R2400	0.12
1	20	5	0.9	230	275	519573	OVR T2-T3 20-275 P TS QS	2CTB803871R2500	0.12
1	20	5	1.4	400	440	519603	OVR T2-T3 20-440 P QS	2CTB803871R1100	0.12
1	20	5	1.4	400	440	519610	OVR T2-T3 20-440 P TS QS	2CTB803871R1300	0.12

Main dimensions mm

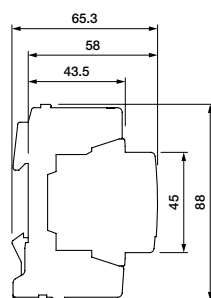

OVR T2-T3 20-275 P QS
OVR T2-T3 20-440 P QS

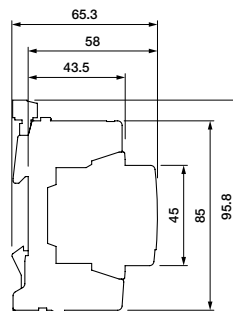

OVR T2-T3 20-275 P TS QS
OVR T2-T3 20-440 P TS QS

Type	Width mm
OVR T2-T3 20-275 P QS	17.8
OVR T2-T3 20-275 P TS QS	17.8
OVR T2-T3 20-440 P QS	17.8
OVR T2-T3 20-440 P TS QS	17.8

OVR Type 2-3 surge protective devices - Single pole 230 and 400 V networks

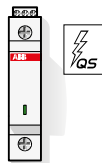

General technical data

Types with auxiliary contact (TS)	OVR T2-T3 20-275 P QS OVR T2-T3 20-275 P TS QS	OVR T2-T3 20-440 P QS OVR T2-T3 20-440 P TS QS
Electrical features		
Standard	IEC 61643-11 / EN 61643-11	
Type / test class	T2-T3 / II-III	T2-T3 / II-III
Protected lines	1	1
System network	TNC - TNS - TT (P-N)	TNC - TNS - TT (P-N)
Type of current	AC 45-65 Hz	AC 45-65 Hz
Voltage regulation of the system network	±20%	±10%
Nominal system voltage Un	230 V	400 V
Max. cont. operating voltage Uc	275 V	440 V
Nominal DC voltage Undc L-PE	320 V DC	320 V DC
Max. DC cont. operating voltage Ucdc L-PE	355 V DC	355 V DC
Maximum discharge current Imax (8/20)	20 kA	20 kA
Nominal discharge current In (8/20)	5 kA	5 kA
Voltage protection level Up at In (L-N)	0.9 kV	1.4 kV
Voltage protection level Up at 3 kA (L-N)	0.8 kV	1.25 kV
Voltage protection level Up at 5 kA (L-N)	0.85 kV	1.35 kV
Voltage protection level Up at 10 kA (L-N)	1 kV	1.55 kV
TOV (Temporary overvoltage) withstand Ut (L-N: 5 s. / N-PE: 200 ms)	337 V / -	581 V / -
Uoc	6 kV	6 kV
Response time	< 25 ns	< 25 ns
Short-circuit withstand capability Iscrr	100 kA	100 kA
Backup protection maximum rating	fuse (gG - gL) circuit breaker (B or C curve)	
	≤ 125 A	≤ 125 A
	≤ 125 A	≤ 125 A
Pluggable cartridge	Yes	Yes
Integrated QuickSafe® technology	Yes	Yes
State indicator	Yes	Yes
Safety reserve	No	No
Auxiliary contact (TS)	Yes (TS option)	Yes (TS option)
Installation		
Wire range (L, N, PE)	solid wire stranded wire	
	2.5...25 mm ² 2.5...16 mm ²	2.5...25 mm ² 2.5...16 mm ²
Stripping length (L, N, PE)	12.5 mm	12.5 mm
Tightening torque (L, N, PE)	2.8 Nm	2.8 Nm
Auxiliary contact (TS)		
Contacts information	1 NO - 1 NC	1 NO - 1 NC
Min. load	12 V DC - 10 mA	12 V DC - 10 mA
Max. load	250 V AC - 1 A	250 V AC - 1A
Connection cross-section	1.5 mm ²	1.5 mm ²
Miscellaneous characteristics		
Stocking and operating temperature	-40...+80 °C	-40...+80 °C
Degree of protection	IP20	IP20
Fire resistance according to UL 94	V0	V0
Dimensions	mm inches	mm inches
	h x w x d 88 x 17.8 x 65.3 mm 3.46 x 0.7 x 2.57 in	h x w x d 88 x 17.8 x 65.3 mm 3.46 x 0.7 x 2.57 in
Dimensions with Auxiliary Contact (TS)	mm inches	mm inches
	h x w x d 95.8 x 17.8 x 65.3 mm 3.77 x 0.7 x 2.57 in	h x w x d 95.8 x 17.8 x 65.3 mm 3.77 x 0.7 x 2.57 in
Replacement cartridges		
Phase product ID	Type Order code	Type Order code
	OVR T2-T3 20-275 C QS 2CTB803876R1200	OVR T2-T3 20-440 C QS 2CTB803876R0600
Neutral product ID	Type Order code	Type Order code
	- -	- -

OVR Type 2-3 surge protective devices TNC - 230 V - 3Ph+PEN networks

2

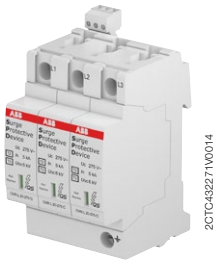

OVR T2 T3 3L 20-275 P TS QS

Description

Type 2 and 3 surge protective devices shall be installed as close as possible to the sensitive equipment to protect. As Type 2 they have been characterized by their capacity to safely discharge current with a 8/20 μ s wave form and they guarantee the coordination with Type 1 SPDs or other Type 2 respecting coordination distances. As Type 3 they are characterized by their capacity to safely discharge current with 1.2/50 μ s wave form, with a very low level of voltage protection level.

Ordering details

Pro- tect- ed lines	Max. dis- charge current I_{max} 8/20 kA	Nominal dis- charge current I_n kA	Voltage protec- tion level U_p kV	Nominal voltage U_n V	Max. cont. operating voltage U_c V	Bbn 3660308 EAN	Type	Order code	Weight Pkg (1 pce) kg
------------------------------	--	---	--	----------------------------------	---	---------------------------	------	------------	--

Pluggable

3	20	5	0.85	230/400	275	519818	OVR T2-T3 3L 20-275 P QS	2CTB803873R3400	0.36
3	20	5	0.85	230/400	275	520661	OVR T2-T3 3L 20-275 P TS QS	2CTB803873R3500	0.36

Main dimensions mm

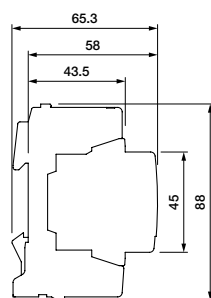

OVR T2-T3 3L 20-275 P QS

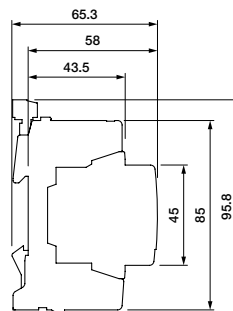

OVR T2-T3 3L 20-275 P TS QS

Type	Width mm
OVR T2-T3 3L 20-275 P QS	53.4
OVR T2-T3 3L 20-275 P TS QS	53.4

2CTC434002S0201

OVR Type 2-3 surge protective devices

TNC - 230 V - 3Ph+PEN networks

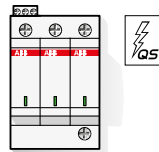

General technical data

Types	OVR T2-T3 3L 20-275 P QS	
with auxiliary contact (TS)	OVR T2-T3 3L 20-275 P TS QS	
Electrical features		
Standard	IEC 61643-11 / EN 61643-11	
Type / test class	T2-T3 / II-III	
Protected lines	3	
System network	TNC	
Type of current	AC 45-65 Hz	
Voltage regulation of the system network	±20%	
Nominal system voltage Un (L-PEN / L-L)	230 / 400 V	
Max. cont. operating voltage Uc (L-PEN)	275 V	
Nominal DC voltage Undc L-PE	320 V DC	
Max. DC cont. operating voltage Ucdc L-PE	355 V DC	
Maximum discharge current Imax (8/20)	20 kA	
Nominal discharge current In (8/20)	5 kA	
Total current	60 kA	
Voltage protection level Up at In	0.85 kV	
Voltage protection level Up at 3 kA	0.8 kV	
Voltage protection level Up at 5 kA	0.85 kV	
Voltage protection level Up at 10 kA	1.0 kV	
TOV (Temporary overvoltage) withstand Ut (L-N: 5 s. / N-PE: 200 ms)	337 V / -	
Uoc	6 kV	
Response time	< 25 ns	
Short-circuit withstand capability Isccr	100 kA	
Backup protection maximum rating	fuse (gG - gL)	≤ 125 A
	circuit breaker (B or C curve)	≤ 125 A
Pluggable cartridge	Yes	
Integrated QuickSafe® technology	Yes	
State indicator	Yes	
Safety reserve	No	
Auxiliary contact (TS)	Yes (TS option)	
Installation		
Wire range (L, N, PE)	solid wire	2.5...25 mm ²
	stranded wire	2.5...16 mm ²
Stripping length (L, N, PE)	12.5 mm	
Tightening torque (L, N, PE)	2.8 Nm	
Auxiliary contact (TS)		
Contacts information	1 NO - 1 NC	
Min. load	12 V DC - 10 mA	
Max. load	250 V AC - 1 A	
Connection cross-section	1.5 mm ²	
Miscellaneous characteristics		
Stocking and operating temperature	-40...+80 °C	
Degree of protection	IP20	
Fire resistance according to UL 94	V0	
Dimensions	mm	h x w x d 88 x 53.4 x 65.3 mm
	inches	h x w x d 3.46 x 2.1 x 2.57 in
Dimensions with auxiliary contact (TS)	mm	h x w x d 95.8 x 53.4 x 65.3 mm
	inches	h x w x d 3.77 x 2.1 x 2.57 in
Replacement cartridges		
Phase product ID	Type	OVR T2-T3 20-275 C QS
	Order code	2CTB803876R1200
Neutral product ID	Type	-
	Order code	-

OVR Type 2-3 surge protective devices TNS - TT - 230 V - 1Ph+N network

2



2CTC432218W0014

OVR T2-T3 1N 20-275 P QS

Description

Type 2 and 3 surge protective devices shall be installed as close as possible to the sensitive equipment to protect. As Type 2 they have been characterized by their capacity to safely discharge current with a 8/20 μ s wave form and they guarantee the coordination with Type 1 SPDs or other Type 2 respecting coordination distances. As Type 3 they are characterized by their capacity to safely discharge current with 1.2/50 μ s wave form, with a very low level of voltage protection level.

Ordering details

Pro- tect- ed lines	Max. dis- charge current I_{max} 8/20 kA	Nominal dis- charge current I_n kA	Voltage protec- tion level U_p kV	Nominal voltage U_n V	Max. cont. operating voltage U_c V	Bbn 3660308 EAN	Type	Order code	Weight Pkg (1 pce) kg
------------------------------	--	---	--	----------------------------------	---	-----------------------	------	------------	--------------------------------

Pluggable

1+1	20	5	1.4	230	275	519689	OVR T2-T3 1N 20-275 P QS	2CTB803972R1200	0.24
1+1	20	5	1.4	230	275	520654	OVR T2-T3 1N 20-275 P TS QS	2CTB803972R1300	0.24

Main dimensions mm

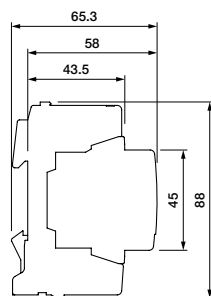

OVR T2-T3 1N 20-275 P QS

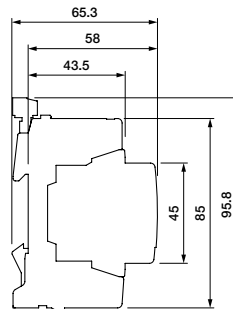

OVR T2-T3 1N 20-275 P TS QS

Type	Width mm
OVR T2-T3 1N 20-275 P QS	35.6
OVR T2-T3 1N 20-275 P TS QS	35.6

2CTC434003S0201

OVR Type 2-3 surge protective devices

TNS - TT - 230 V - 1Ph+N network

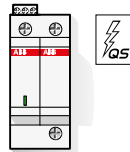

General technical data

Types	OVR T2-T3 1N 20-275 P QS		
with auxiliary contact (TS)	OVR T2-T3 1N 20-275 P TS QS		
Electrical features			
Standard	IEC 61643-11 / EN 61643-11		
Type / test class	T2-T3 / II-III		
Protected lines	1+1		
System network	TNS - TT		
Type of current	AC 45-65 Hz		
Voltage regulation of the system network	±20%		
Nominal system voltage Un	230 V		
Max. cont. operating voltage U _c	275 V		
Maximum discharge current I _{max} (8/20)	20 kA		
Nominal discharge current I _n (8/20)	5 kA		
Total current	40 kA		
Voltage protection level Up at I _n (L-N / N-PE / L-PE)	0.9 / 1.4 / 1.4 kV		
Voltage protection level Up at 3 kA (L-N / N-PE / L-PE)	0.8 / 1.4 / 0.85 kV		
Voltage protection level Up at 5 kA (L-N / N-PE / L-PE)	0.85 / 1.4 / 0.95 kV		
Voltage protection level Up at 10 kA (L-N / N-PE / L-PE)	1 / 1.4 / 1.15 kV		
TOV (Temporary overvoltage) withstand U _t (L-N: 5s. / N-PE: 200 ms)	337 / 1200 V		
U _{oc}	6 kV		
Response time	< 25 ns		
Residual current I _{PE}	< 10 μA		
Short-circuit withstand capability I _{scrc}	100 kA		
Backup protection maximum rating	fuse (gG - gL)	≤ 125 A	
	circuit breaker (B or C curve)	≤ 125 A	
Pluggable cartridge	Yes		
Integrated QuickSafe® technology	Yes		
State indicator	Yes		
Safety reserve	No		
Auxiliary contact (TS)	Yes (TS option)		
Installation			
Wire range (L, N, PE)	solid wire	2.5...25 mm ²	
	stranded wire	2.5...16 mm ²	
Stripping length (L, N, PE)	12.5 mm		
Tightening torque (L, N, PE)	2.8 Nm		
Auxiliary contact (TS)			
Contacts information	1 NO - 1 NC		
Min. load	12 V DC - 10 mA		
Max. load	250 V AC - 1 A		
Connection cross-section	1.5 mm ²		
Miscellaneous characteristics			
Stocking and operating temperature	-40...+80 °C		
Degree of protection	IP20		
Fire resistance according to UL 94	V0		
Dimensions	mm	h x w x d	88 x 35.6 x 65.3 mm
	inches	h x w x d	3.46 x 1.4 x 2.57 in
Dimensions with auxiliary contact (TS)	mm	h x w x d	95.8 x 35.6 x 65.3 mm
	inches	h x w x d	3.77 x 1.4 x 2.57 in
Replacement cartridges			
Phase product ID	Type	OVR T2-T3 20-275 C QS	
	Order code	2CTB803876R1200	
Neutral product ID	Type	OVR T2 N 80-275 C QS	
	Order code	2CTB803876R0000	

OVR Type 2-3 surge protective devices TT - 230 V and 400 V - 3Ph+N networks

2

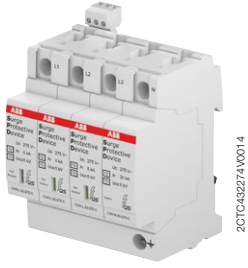

OVR T2-T3 3N 20-275 P TS QS

Description

Type 2 and 3 surge protective devices shall be installed as close as possible to the sensitive equipment to protect. As Type 2 they have been characterized by their capacity to safely discharge current with a 8/20 μ s wave form and they guarantee the coordination with Type 1 SPDs or other Type 2 respecting coordination distances. As Type 3 they are characterized by their capacity to safely discharge current with 1.2/50 μ s wave form, with a very low level of voltage protection level.

Ordering details

Protected lines	Max. discharge current I_{max} 8/20 kA	Nominal discharge current I_n kA	Voltage protection level U_p kV	Nominal voltage U_n V	Max. cont. operating voltage U_c V	Bbn 3660308 EAN	Type	Order code	Weight Pkg (1 pce) kg
-----------------	---	--	---	-------------------------------	--	-----------------------	------	------------	--------------------------------

Pluggable

3+1	20	5	1.4	230/400	275	519924	OVR T2-T3 3N 20-275 P QS	2CTB803973R1200	0.48
3+1	20	5	1.4	230/400	275	520692	OVR T2-T3 3N 20-275 P TS QS	2CTB803973R1600	0.48
3+1	20	5	1.5	400/690	440	519986	OVR T2-T3 3N 20-440 P QS	2CTB803973R1300	0.48

Main dimensions mm

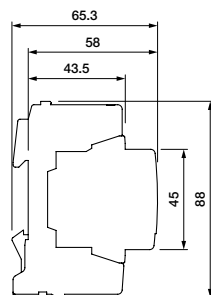

OVR T2-T3 3N 20-275 P QS
OVR T2-T3 3N 20-440 P QS

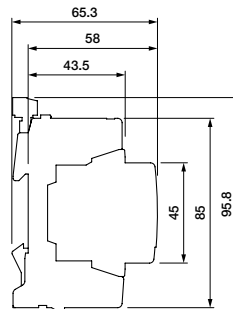

OVR T2-T3 3N 20-275 P TS QS

Type	Width mm
OVR T2-T3 3N 20-275 P QS	71.2
OVR T2-T3 3N 20-275 P TS QS	71.2
OVR T2-T3 3N 20-440 P QS	71.2

OVR Type 2-3 surge protective devices

TT - 230 V and 400 V - 3Ph+N networks

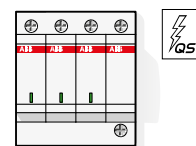
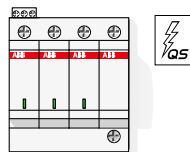

General technical data

Types with auxiliary contact (TS)	OVR T2-T3 3N 20-275 P QS OVR T2-T3 3N 20-275 P TS QS	OVR T2-T3 3N 20-440 P QS -
Electrical features		
Standard	IEC 61643-11 / EN 61643-11	
Type / test class	T2-T3 / II-III	T2-T3 / II-III
Protected lines	3+1	3+1
System network	TNS - TT	TNS - TT
Type of current	AC 45-65 Hz	AC 45-65 Hz
Voltage regulation of the system network	±20%	±10%
Nominal system voltage Un (L-N / L-L)	230 / 400 V	400 / 690 V
Max. cont. operating voltage Uc (L-N / L-L)	275 V	440 V
Maximum discharge current Imax (8/20)	20 kA	20 kA
Nominal discharge current In (8/20)	5 kA	5 kA
Total Current	80 kA	80 kA
Voltage protection level Up at In (L-N / N-PE / L-PE)	0.9 / 1.4 / 1.4 kV	1.4 / 1.4 / 1.4 kV
Voltage protection level Up at 3 kA (L-N / N-PE / L-PE)	0.8 / 1.4 / 0.85 kV	1.25 / 1.4 / 1.45 kV
Voltage protection level Up at 5 kA (L-N / N-PE / L-PE)	0.85 / 1.4 / 0.95 kV	1.35 / 1.4 / 1.45 kV
Voltage protection level Up at 10 kA (L-N / N-PE / L-PE)	1 / 1.4 / 1.15 kV	1.55 / 1.4 / 1.65 kV
TOV (Temporary overvoltage) withstand Ut (L-N: 5s. / N-PE: 200 ms)	337 / 1200 V	581 / 1200 V
Uoc	6 kV	6 kV
Response time	< 25 ns	< 25 ns
Residual current IPE	< 10 µA	< 10 µA
Short-circuit withstand capability Iscrr	100 kA	100 kA
Backup protection maximum rating	fuse (gG - gL) circuit breaker (B or C curve)	
	≤ 125 A	≤ 125 A
	≤ 125 A	≤ 125 A
Pluggable cartridge	Yes	Yes
Integrated QuickSafe® technology	Yes	Yes
State indicator	Yes	Yes
Safety reserve	No	No
Auxiliary contact (TS)	Yes (TS option)	No
Installation		
Wire range (L, N, PE)	solid wire stranded wire	
	2.5...25 mm ² 2.5...16 mm ²	2.5...25 mm ² 2.5...16 mm ²
Stripping length (L, N, PE)	12.5 mm	12.5 mm
Tightening torque (L, N, PE)	2.8 Nm	2.8 Nm
Auxiliary contact (TS)		
Contacts information	1 NO - 1 NC	1 NO - 1 NC
Min. load	12 DC - 10 mA	12 DC - 10 mA
Max. load	250 V AC - 1 A	250 V AC - 1 A
Connection cross-section	1.5 mm ²	1.5 mm ²
Miscellaneous characteristics		
Stocking and operating temperature	-40...+80 °C	-40...+80 °C
Degree of protection	IP20	IP20
Fire resistance according to UL 94	V0	V0
Dimensions	mm inches	mm inches
	h x w x d 88 x 71.2 x 65.3 mm 3.46 x 2.8 x 2.57 in	88 x 71.2 x 65.3 mm 3.46 x 2.8 x 2.57 in
Dimensions with auxiliary contact (TS)	mm inches	mm inches
	h x w x d 95.8 x 71.2 x 65.3 mm 3.77 x 2.8 x 2.57 in	- -
Replacement cartridges		
Phase product ID	Type Order code	Type Order code
	OVR T2-T3 20-275 C QS 2CTB803876R1200	OVR T2-T3 20-440 C QS 2CTB803876R0600
Neutral product ID	Type Order code	Type Order code
	OVR T2 N 80-275 C QS 2CTB803876R0000	OVR T2 N 80-440 C QS 2CTB803886R0100

OVR Type 3 surge protective devices TNS - TT - 230 V networks

2



2CSC400032F0013

OVR 3N 10 275

Description

Type 3 surge protective devices shall be installed as close as possible from the sensitive equipment to protect. Tested with a 1.2/50 - 8/20 current combination wave generator, they ensure a very low protection level.

Ordering details

Pro- tect- ed lines	Max. dis- charge current I_{max} 8/20 kA	Nominal dis- charge current I_n kA	Voltage protec- tion level U_p kV	Nominal voltage U_n V	Max. cont. operating voltage U_c V	Bbn 3660308 EAN	Type	Order code	Weight Pkg (1 pce) kg
Type 3 unpluggable - U_c 275 V									
1+1	10	3	0.9	230	275	509208	OVR 1N 10 275	2CTB813912R1000	0.27
3+1	10	3	0.9	230/400	275	509215	OVR 3N 10 275	2CTB813913R1000	0.48

Main dimensions mm

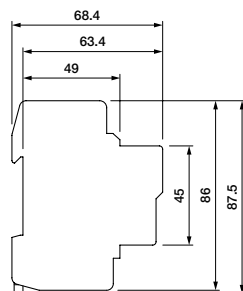

OVR 1N 10 275
OVR 3N 10 275

Type	Width mm
OVR 1N 10 275	35.6
OVR 3N 10 275	71.2

2CTC434006S0201

OVR Type 3 surge protective devices

TNS - TT - 230 V networks

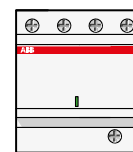
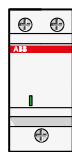

General technical data

		OVR 1N 10 275	OVR 3N 10 275
Types		OVR 1N 10 275	OVR 3N 10 275
with auxiliary contact (TS)		-	-
Technology		Varistor	Varistor
Electrical features			
Standard		IEC 61643-1 / EN 61643-11	
Type / test class		T3 / III	T3 / III
Protected lines		1+1	3+1
Types of networks		TNS - TT	TNS - TT
Type of current		AC	AC
Nominal voltage Un (L-N/L-L)		230 V	230 / 400 V
Max. cont. operating voltage Uc		275 V	275 V
Maximum discharge current Imax (8/20)		10 kA	10 kA
Nominal discharge current In (8/20)		3 kA	3 kA
Combination wave Uoc		6 kV	6 kV
Voltage protection level Up at In (L-N/N-PE/L-PE)		0.9 / 1.4 kA	0.9 / 1.4 kA
Voltage protection level Up at 3 kA (L-N/N-PE/L-PE)		0.9 / 0.9 kA	0.9 / 0.9 kA
TOV (Temporary overvoltage) withstand Ut (L-N: 5 s / N-PE: 200 ms)		334 / 440 V	334 / 440 V
Response time		≤ 25 ns	≤ 25 ns
Residual current IPE		10 µA	10 µA
Short-circuit withstand capability Isccr		10 kA	10 kA
Backup protection	Fuse (gG - gL)	≤ 25 A	≤ 25 A
	Circuit breaker (B or C curve)	≤ 10 A	≤ 10 A
Pluggable cartridge		No	No
Integrated thermal disconnector		Yes	Yes
State indicator		Yes	Yes
Safety reserve		No	No
Auxiliary contact (TS)		No	No
Installation			
Wire range (L, N, PE)	Solid wire	2.5...25 mm ²	2.5...25 mm ²
	Stranded wire	2.5...16 mm ²	2.5...16 mm ²
Stripping length (L, N, PE)		12.5 mm	12.5 mm
Tightening torque (L, N, PE)		2.5 Nm	2.5 Nm
Auxiliary contact (TS)			
Contact complement		-	-
Minimum load		-	-
Maximum load		-	-
Connection cross-section		-	-
Miscellaneous characteristics			
Stocking temperature		-40...+80 °C	-40...+80 °C
Operating temperature		-40...+70 °C	-40...+70 °C
Degree of protection		IP20	IP20
Fire resistance according to UL 94		V0	V0
Dimensions	mm	h x w x d 87.5 x 35.6 x 68.4 mm	87.5 x 71.2 x 68.4 mm
	inches	h x w x d 3.44 x 1.4 x 2.69 in	3.44 x 2.8 x 2.69 in

OVR Plus autoprotected surge protective devices

TNS - TT - 230 V networks

2



OVR PLUS N1 20
OVR PLUS N1 40



OVR PLUS N3 20
OVR PLUS N3 40

OVR PLUS N3 20 and OVR PLUS N3 40 for commercial and industrial applications

- Auto-protected: Backup miniature circuit breaker integrated and fully coordinated with the surge protective device.
- Easy installation: fully coordinated unit with easy wiring with the complete ABB pro M modular range.
- High discharge capacity: with I_{max} 20 and 40 kA the OVR Plus N3 insure the protection of your low voltage installations and electric equipment.
- High reliability: no welding inside the module and specific thermal disconnection with the "bilame" sensor.

OVR PLUS N1 40 for residential applications

- Auto-protected: backup miniature circuit breaker integrated and fully coordinated with the surge protective device.
- Compact: only two modules (36 mm width), means more space and easy wiring with the complete ABB DIN rail range.
- High discharge capacity: with I_{max} 20 and 40 kA the OVR PLUS N1 can protect your electric equipment against high surges.
- High reliability: no welding inside the module and specific thermal disconnection.

Ordering details

Pro- tected lines	Max. dis- charge current I _{max} 8/20 kA	Nominal discharge current I _n kA	Voltage protec- tion level U _p kV	Nominal voltage U _n V	Max. cont. operating voltage U _c V	Bbn 3660308 EAN	Type	Order code	Weight Pkg (1 pce) kg
-------------------------	---	---	---	---	---	-----------------------	------	------------	--------------------------------

Type 2 autoprotected

1+1	20	5	1.3	230	275	521286	OVR PLUS N1 20	2CTB803701R0700	0.28
1+1	40	20	1.8	230	275	517005	OVR PLUS N1 40	2CTB803701R0100	0.28
3+1	20	5	1.3	230/400	275	517081	OVR PLUS N3 20	2CTB803701R0400	0.84
3+1	40	20	2.0	230/400	275	517074	OVR PLUS N3 40	2CTB803701R0300	0.84

Main dimensions mm

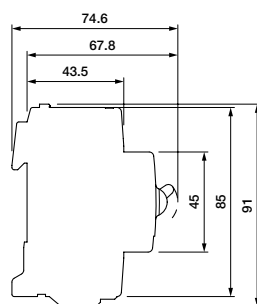

OVR PLUS N1 20
OVR PLUS N1 40

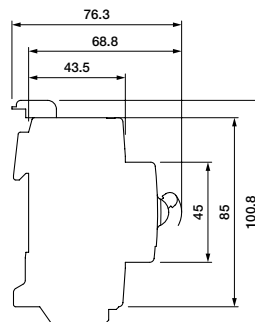

OVR PLUS N3 20
OVR PLUS N3 40

Type	Width mm
OVR PLUS N1 20	35.6
OVR PLUS N1 40	35.6
OVR PLUS N3 20	106.8
OVR PLUS N3 40	106.8

OVR Plus autoprotected surge protective devices

TNS - TT - 230 V networks

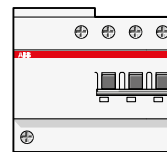

General technical data

			OVR PLUS N1 20	OVR PLUS N1 40	OVR PLUS N3 20	OVR PLUS N3 40
Types with auxiliary contact (TS)			–	–	–	–
Technology			Varistor	Varistor	Varistor	Varistor
Electrical features			IEC 61643-1 / EN 61643-11			
Standard			IEC 61643-1 / EN 61643-11			
Type / test class			T2 / II	T2 / II	T2 / II	T2 / II
Protected lines			1+1	1+1	3+1	3+1
Types of networks			TNS - TT	TNS - TT	TNS - TT	TNS - TT
Type of current			AC	AC	AC	AC
Nominal voltage Un (L-N/L-L)			230 V	230 V	230 / 400 V	230 / 400 V
Max. cont. operating voltage Uc			275 V	275 V	275 V	275 V
Maximum discharge current I _{max} (8/20)			20 kA	40 kA	20 kA	40 kA
Nominal discharge current I _n (8/20)			5 kA	20 kA	5 kA	20 kA
Voltage protection level Up at I _n (L-N/N-PE/L-PE)			1.3 / - / 1.3 kV	1.6 / - / 1.8 kV	1.3 / 1.3 / 1.3 kV	2.0 / 1.5 / 2.0 kV
Voltage protection level Up at 3 kA (L-N/N-PE/L-PE)			1.1 / - / 1.1 kV	1.1 / - / 1.1 kV	1.1 / 1.1 / 1.1 kV	1.1 / 1.1 / 1.1 kV
TOV (Temporary overvoltage) withstand Ut (L-N: 5 s / N-PE: 200 ms)			334 / 1200 V	334 / 1200 V	334 / 1200 V	334 / 1200 V
Response time			≤ 25 ns	≤ 25 ns	≤ 25 ns	≤ 25 ns
Residual current IPE			10 µA	10 µA	10 µA	10 µA
Short-circuit withstand capability I _{sc}			10 kA	15 kA	10 kA	15 kA
Backup protection			Fuse (gG - gL)	integrated	integrated	integrated
			Circuit breaker (B or C curve)	integrated	integrated	integrated
Pluggable cartridge			No	No	No	No
Integrated thermal disconnecter			Yes	Yes	Yes	Yes
State indicator			Yes	Yes	Yes	Yes
Safety reserve			No	No	No	No
Auxiliary contact			Yes (S2C-H6R / 2CDS200912R0001)			
Installation						
Wire range (L, N, PE)			Solid wire	2.5...25 mm ²	2.5...25 mm ²	2.5...25 mm ²
			Stranded wire	2.5...16 mm ²	2.5...16 mm ²	2.5...16 mm ²
Stripping length (L, N, PE)			11 mm	11 mm	11 mm	11 mm
Tightening torque (L, N, PE)			2.5 Nm	2.5 Nm	2.5 Nm	2.5 Nm
Auxiliary contact (TS)			–	–	–	–
Contact complement			–	–	–	–
Minimum load			–	–	–	–
Maximum load			–	–	–	–
Connection cross-section			–	–	–	–
Miscellaneous characteristics						
Stocking temperature			-40...+70 °C	-40...+70 °C	-40...+70 °C	-40...+70 °C
Operating temperature			-25...+55 °C	-25...+55 °C	-25...+55 °C	-25...+55 °C
Degree of protection			IP20	IP20	IP20	IP20
Fire resistance according to UL 94			V0	V0	V0	V0
Dimensions			mm	h x w x d 91 x 35.6 x 74.6 mm	91 x 35.6 x 74.6 mm	100.8 x 106.8 x 76.3 mm
			inches	h x w x d 3.58 x 1.4 x 2.94 in	3.58 x 1.4 x 2.94 in	3.97 x 4.2 x 3 in

OVR Type 2-3 surge protective devices

StreetLight applications

TT - TN - 230 V networks



OVR T2-T3 StreetLight

Description

This is a particular Type 2 and 3 surge protective devices meant to be installed in applications where overall dimensions are critical.

It has the Safety system integrated by default, performed by two varistors in parallel, allowing the customer to perform preventive maintenance. As soon as one of the Life status windows swap from green to red, we know the product needs to be replaced, but it still guarantees the protection.

It has IP32 and bottom connections to guarantee the best performances in critical and humid environment.

Ordering details

Pro- tect- ed lines	Max. dis- charge current I_{max} 8/20 kA	Nominal dis- charge current I_n kA	Voltage protec- tion level U_p kV	Nominal voltage U_n V	Max. cont. operating voltage U_c V	Bbn 3660308 EAN	Type	Order code	Weight Pkg (1 pce) kg
1+1	15	5	1.3	230	275	524775	OVR T2-T3 N1 15-275s SL	2CTB804500R0200	0.04
1+1	15	5	1.3	230	275	524799	OVR T2-T3 N1 15-275s SL (x20)	2CTB804500Z1200	0.04

(x20) packaging of 20 pieces.

Main dimensions mm

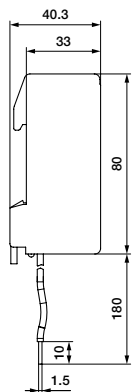

OVR T2-T3 N1 15-275s SL

Type	Width mm
OVR T2-T3 N1 15-275s SL	17.5

OVR Type 2-3 surge protective devices

StreetLight applications

TT - TN - 230 V networks



General technical data

Types	OVR T2-T3 N1 15-275s SL	
Electrical features		
Standard	IEC 61643-11 / EN 61643-11	
Type / test class	T2-T3 / II-III	
System network	TT, TN	
Protected lines	Common + differential	
Number of pole / Type of current	1+1	
Nominal system voltage Un	230 V	
Max. cont. operating voltage Uc (L-N)	275 V	
Maximum discharge current Imax (8/20)	15 kA	
Nominal discharge current In (8/20)	5 kA	
Total Current	30 kA	
Voltage protection level Up at In (L-N / L-PE)	1.1 / 1.3 kV	
TOV (Temporary overvoltage) withstand Ut (L-N: 5s.)	337 V	
Uoc	1.1 kV	
Response time	< 25 ns	
Short circuit withstand Icc	15 kA	
Backup protection maximum rating	fuse (gG - gL)	< 20 A
	circuit breaker (B or C curve)	< 20 A
Pluggable cartridge	No	
Integrated QuickSafe® technology	No	
State indicator	Yes	
Safety reserve	No	
Installation		
Wire range : phase and neutral wire	2 x 1.5 mm ² - L 16 cm	
Wire range : protective earth wire	< 6 mm ²	
Stripping length (L, N, PE)	10 mm	
Auxiliary contact (TS)		
Contacts information	-	
Min. load	-	
Max. load	-	
Connection cross-section	-	
Miscellaneous characteristics		
Stocking and operating temperature	-40...+80 °C	
Degree of protection	IP32	
Fire resistance according to UL 94	V0	
Dimensions	mm	h x w x d 80 x 17.5 x 41 mm
	inches	h x w x d 3.15 x 0.69 x 1.62 in
Dimensions with auxiliary contact (TS)	mm	h x w x d -
	inches	h x w x d -

OVR PV surge protective devices

Photovoltaic applications

2



2CSC400034F0013

OVR PV T1 6.25-600 P TS



2CSC400033F0013

OVR PV 40-600 P



1TXH000211F0000

OVR PV 40-1000 P TS BW

Description

Specifically designed for photovoltaic DC installations, the OVR PV family provide a safe and reliable surge and lightning protection of solar panels and converters.

The OVR PV surge protective devices comply with UTE C 61-740-51 and prEN 50539-11.

Ordering details

Protected lines	Impulse current Iimp 10/350 kA	Max. discharge current Imax 8/20 kA	Nominal discharge current In kA	Voltage protection level Up kV	Max. cont. operating voltage Ucpv V	Bbn 3660308 EAN	Type	Order code	Weight Pkg (1 pce) kg
-----------------	---	--	---------------------------------------	--------------------------------------	---	-----------------------	------	------------	--------------------------------

Type 1 PV - Pluggable

2	6.25	-	6.25	1.9	670	518361	OVR PV T1 6.25-600 P TS	2CTB803953R5700	1.10
2	6.25	-	6.25	2.5	1100	518378	OVR PV T1 6.25-1000 P TS	2CTB803953R6700	1.10

Type 2 PV - Pluggable

2	-	40	20	1.4	670	516510	OVR PV 40-600 P	2CTB803953R5300	0.38
2	-	40	20	1.4	670	516527	OVR PV 40-600 P TS	2CTB803953R5400	0.38
2	-	40	20	3.8	1100	516534	OVR PV 40-1000 P	2CTB803953R6400	0.38
2	-	40	20	3.8	1100	516541	OVR PV 40-1000 P TS	2CTB803953R6500	0.38
2	-	40	20	3.8	1100	526243	OVR PV T2 40-1000 P QS	2CTB804153R2400	0.38
2	-	40	20	3.8	1100	516503	OVR PV 40-1000 P TS BW (x30)	2CTB804153R1900	0.38
2	-	40	15	4.5	1500	524843	OVR PV 40-1500 P BW	2CTB804153R2200	0.38
2	-	40	15	4.5	1500	524836	OVR PV 40-1500 P TS BW	2CTB804153R2100	0.38

(x30) packaging of 30 pieces.

Main dimensions mm

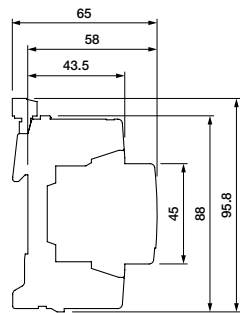

OVR PV T1 6.25-600 P TS
OVR PV T1 6.25-1000 P TS

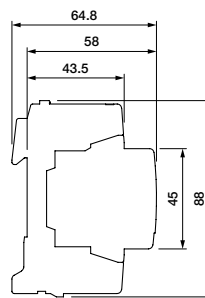

OVR PV 40-600 P
OVR PV 40-1000 P

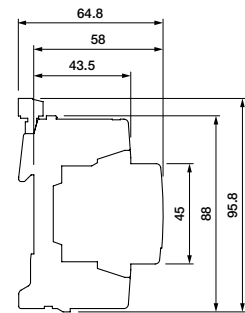

OVR PV 40-600 P TS
OVR PV 40-1000 P TS

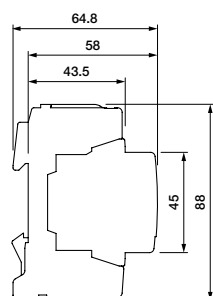

OVR PV T2 40-1000 P QS
OVR PV 40-1500 P BW

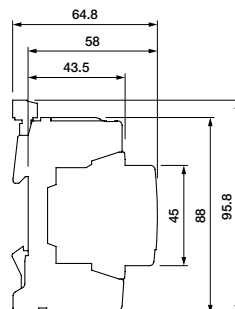

OVR PV 40-1000 P TS BW
OVR PV 40-1500 P TS BW

Type	Width mm
OVR PV T1 6.25-600 P TS	160.2
OVR PV T1 6.25-1000 P TS	160.2
OVR PV 40-600 P	53.4
OVR PV 40-600 P TS	53.4
OVR PV 40-1000 P	53.4
OVR PV T2 40-1000 P QS	53.4
OVR PV 40-1000 P TS	53.4
OVR PV 40-1000 P TS BW	53.4
OVR PV 40-1500 P BW	53.4
OVR PV 40-1500 P TS BW	53.4

2CTC431005S0201

OVR PV surge protective devices

Photovoltaic applications

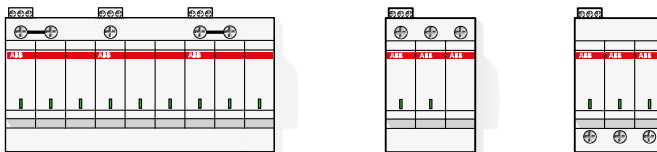

General technical data

Types				OVR PV 40-600 P	OVR PV 40-1000 P	OVR PV 40-1500 P BW	
with auxiliary contact (TS)					OVR PV T2 40-1000 P QS		
Technology		Varistor	Varistor	Varistor	Varistor	Varistor	
Electrical features							
Standard		UTE C 61-740-51 / prEN 50539-11				EN 50539-11	
Type / test class		T1 / I	T1 / I	T2 / II	T2 / II	T2 / II	
Protected lines		2	2	2	2	2	
Types of networks		Photovoltaic	Photovoltaic	Photovoltaic	Photovoltaic	Photovoltaic	
Type of current		DC	DC	DC	DC	DC	
Nominal voltage Un (L-N/L-L)		600 V	1000 V	600 V	1000 V	1500 V	
Max. cont. operating voltage Ucpv		670 V	1100 V	670 V	1100 V	1500 V	
Impulse current Iimp (10/350)		6.25 kA	6.25 kA	–	–	–	
Maximum discharge current Imax (8/20)		–	–	40 kA	40 kA	40 kA	
Nominal discharge current In (8/20)		6.25 kA	6.25 kA	20 kA	20 kA	15 kA	
Voltage protection level Up at In		1.9 / 1.9 kV	2.5 / 2.5 kV	2.8 / 1.4 kV	3.8 / 3.8 kV	4.5 kV	
Response time		≤ 25 ns	≤ 25 ns	≤ 25 ns	≤ 25 ns	≤ 25 ns	
Residual current IPE		75 µA	75 µA	10 µA	75 µA	< 30 µA	
Short-circuit DC current Iscpvcv		100 A	100 A	300 A	10000 A	10000 A	
Disconnector							
Fuse		10AgPV (E90PV)	10AgPV (E90PV)	10AgPV (E90PV)	No need	No need	
Circuit breaker		–	–	S802PV-S10	No need	No need	
Pluggable cartridge		Yes	Yes	Yes	Yes	Yes	
Integrated specific thermal disconnector		Yes	Yes	Yes	Yes	Yes	
State indicator		Yes	Yes	Yes	Yes	Yes	
Safety reserve		No	No	No	No	No	
Auxiliary contact (TS)		Yes	Yes	Yes (TS option)	Yes (TS option)	Yes (TS option)	
Installation							
Wire range (L, N, PE)							
Solid wire		2.5...25 mm ²	2.5...25 mm ²	2.5...25 mm ²	2.5...25 mm ²	2.5...25 mm ²	
Stranded wire		2.5...16 mm ²	2.5...16 mm ²	2.5...16 mm ²	2.5...16 mm ²	2.5...16 mm ²	
Stripping length (L, N, PE)		12.2 mm	12.2 mm	12.2 mm	12.2 mm	12.2 mm	
Tightening torque (L, N, PE)		2.5 Nm	2.5 Nm	2.5 Nm	2.5 Nm	2.5 Nm	
Auxiliary contact (TS)							
Contact complement		1 NO - 1 NC	1 NO - 1 NC	1 NO - 1 NC	1 NO - 1 NC	1 NO - 1 NC	
Minimum load		12 V DC - 10 mA	12 V DC - 10 mA	12 V DC - 10 mA	12 V DC - 10 mA	12 DC - 10 mA	
Maximum load		250 V AC - 1 A	250 V AC - 1 A	250 V AC - 1 A	250 V AC - 1 A	250 V AC - 1 A	
Connection cross-section		1.5 mm ²	1.5 mm ²	1.5 mm ²	1.5 mm ²	1.5 mm ²	
Miscellaneous characteristics							
Stocking and operating temperature		-40...+80 °C	-40...+80 °C	-40...+80 °C	-40...+80 °C	-40...+80 °C	
Degree of protection		IP20	IP20	IP20	IP20	IP20	
Fire resistance according to UL 94		V0	V0	V0	V0	V0	
Dimensions							
mm		h x w x d	–	88 x 53.4 x 64.8 mm	88 x 53.4 x 64.8 mm	88 x 53.4 x 64.8 mm	
inches		h x w x d	–	3.46 x 2.1 x 2.55 in	3.46 x 2.1 x 2.55 in	3.46 x 2.1 x 2.55 in	
Dimensions with auxiliary contact (TS)							
mm		h x w x d	95.8 x 160.2 x 65 mm	95.8 x 160.2 x 65 mm	95.8 x 53.4 x 64.8 mm	95.8 x 53.4 x 64.8 mm	
inches		h x w x d	3.77 x 6.31 x 2.56 in	3.77 x 6.31 x 2.56 in	3.77 x 2.1 x 2.55 in	3.77 x 2.1 x 2.55 in	
Replacement cartridges							
Phase product ID							
Type		OVR PV T1 625-600 C	OVR PV T1 6.25-1000 C	OVR PV 40-600 C	OVR PV 40-1000 C	OVR PV 40-1500 C	
Order code		2CTB803950R1000	2CTB803950R1100	2CTB803950R0000	2CTB803950R0100	2CTB803950R1000	

OVR WT surge protective devices

Wind turbine applications

2



OVR WT 3L 690 P TS

Description

Due to their height, wind turbines have especially high exposure to lightning, they need high capacity and reliable lightning and surge protection.

The OVR WT family takes into consideration the specificity of wind installations with a high peak repetitive voltage withstand (U_{rp} up to 3 kV) ensure a safe protection to Wind applications.

It can be DIN mounted with the OVR WT 3L 690 P TS or fixed close to the equipments to protect with the OVR WT 3L 690 enclosure solution.

Ordering details

Protected lines	Impulse current I _{imp} 10/350 kA	Max. discharge current I _{max} 8/20 kA	Nominal discharge current I _n kA	Voltage protection level U _p kV	Nominal voltage U _n V	Bbn 3660308 EAN	Type	Order code	Weight Pkg (1 pce) kg
-----------------	---	--	---	--	--	---------------------------	------	------------	--------------------------------

Type 1+2 WT - Pluggable

3	2	40	20	6	400/690	518507	OVR WT 3L 690 P TS	2CTB235402R0000	1.67
---	---	----	----	---	---------	--------	--------------------	-----------------	------

Main dimensions mm

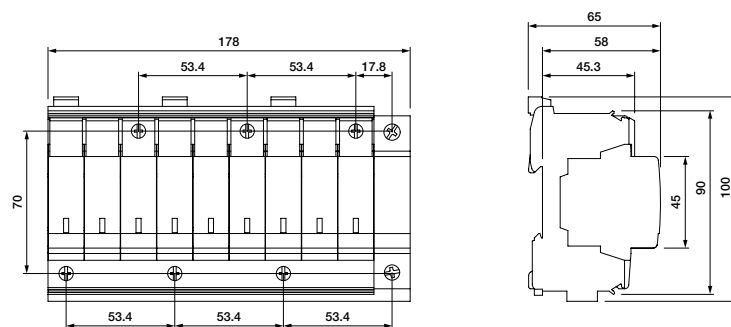

OVR WT 3L 690 P TS

Type	Width mm
OVR WT 3L 690 P TS	178.0

OVR WT surge protective devices

Wind turbine applications

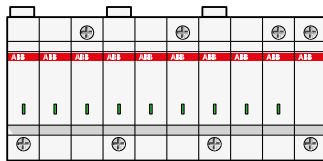

General technical data

Types	-		
with auxiliary contact (TS)	OVR WT 3L 690 P TS		
Technology	Varistor		
Electrical features			
Standard	IEC 61643-1 / EN 61643-11		
Type / test class	T1+2 / I+II		
Protected lines	3		
Types of networks	TNC		
Type of current	AC		
Nominal voltage Un (L-N/L-L)	400 / 690 V		
Peak repetitive voltage withstand Urp (L-PE/L-L)	3000 / 3400 V		
Max. cont. operating voltage Uc (L-PE / L-L)	690 V		
Maximum impulse current Iimp (10/350)	2 kA		
Maximum discharge current Imax (8/20)	40 kA		
Nominal discharge current In (8/20)	20 kA		
Follow current interrupting rating I _{fi}	-		
Voltage protection level Up at In	6 kV		
Voltage protection level Up at 3 kA	4.4 kV		
Response time	≤ 100 ns		
Residual current IPE	10 μA		
Short-circuit withstand capability I _{sc}	50 kA		
Backup protection	fuse (gG - gL)	≤ 125 A	
	circuit breaker (B or C curve)	≤ 125 A	
Pluggable cartridge	Yes		
Integrated thermal disconnecter	Yes		
State indicator	Yes		
Safety reserve	No		
Auxiliary contact (TS)	Yes		
Installation			
Wire range (L, N, PE)	Solid wire	2.5...25 mm ²	
	Stranded wire	2.5...16 mm ²	
Stripping length (L, N, PE)	11 mm		
Tightening torque (L, N, PE)	2.5 Nm		
Auxiliary contact (TS)			
Contact complement	1 NO - 1 NC		
Minimum load	12 V DC - 10 mA		
Maximum load	250 V AC - 1 A		
Connection cross-section	1.5 mm ²		
Miscellaneous characteristics			
Stocking and operating temperature	-40...+80 °C		
Degree of protection	IP20		
Fire resistance according to UL 94	V0		
Dimensions	mm	h x w x d	100 x 178 x 65 mm
	inches	h x w x d	3.94 x 7.01 x 2.56 in

OVR TC surge protective devices

Dataline protection

2



OVR TC 200FR P



Base OVR TC RJ 45

Description

The OVR TC family offers a reliable surge protection to dataline networks for datacenters, water treatment installations or wind turbine installations.

With the RJ11 and RJ45 bases they allow a flexible and easy installation..

Ordering details

Protected lines	Max. discharge current I _{max} 8/20 kA	Nominal/rated current I _n /I _L kA/mA	Voltage protection level U _p V	Nominal voltage U _n V	Max. cont. operating voltage U _c V	Bbn 3660308 EAN	Type	Order code	Weight Pkg (1 pce) kg
-----------------	--	--	---	--	---	-----------------------	------	------------	--------------------------------

Dataline protection modules - Pluggable

1 pair	10	5 / 140	15	6	7	515230	OVR TC 06V P	2CTB804820R0000	0.07
1 pair	10	5 / 140	20	12	14	515247	OVR TC 12V P	2CTB804820R0100	0.07
1 pair	10	5 / 140	35	24	27	515254	OVR TC 24V P	2CTB804820R0200	0.07
1 pair	10	5 / 140	70	48	53	515261	OVR TC 48V P	2CTB804820R0300	0.07
1 pair	10	5 / -	700	200	220	515278	OVR TC 200V P	2CTB804820R0400	0.07
1 pair	10	5 / 140	400	200	220	515285	OVR TC 200FR P	2CTB804820R0500	0.07

Bases

-	-	-	-	-	-	515605	BASE OVR TC RJ45	2CTB804840R1100	0.07
---	---	---	---	---	---	--------	------------------	-----------------	------

Main dimensions mm

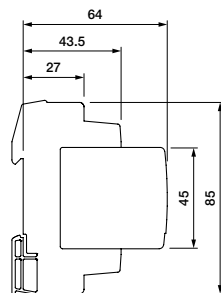

Type	Width mm
OVR TC 06V P	12
OVR TC 12V P	12
OVR TC 24V P	12
OVR TC 48V P	12
OVR TC 200V P	12
OVR TC 200FR P	12
BASE OVR TC RJ45	24

- OVR TC 06V P
- OVR TC 12V P
- OVR TC 24V P
- OVR TC 48V P
- OVR TC 200V P
- OVR TC 200FR P

OVR TC surge protective devices

Dataline protection



General technical data

		OVR TC 06V P	OVR TC 12V P	OVR TC 24V P	OVR TC 48V P	OVR TC 200V P	OVR TC 200FR P
Types with auxiliary contact (TS)		-	-	-	-	-	-
Connection configuration		Serial	Serial	Serial	Serial	Parallel	Serial
Electrical features							
Standard		IEC/EN 61643-21					
Type / test class		C2	C2	C2	C2	C2	C2
Protected lines		1 pair	1 pair	1 pair	1 pair	1 pair	1 pair
Types of networks		MIC/T2 - RS422/485	RS232	LS - 4/20 mA	RNIS	ADSL	RTC / Analogue
Type of current		DC	DC	DC	DC	DC	DC
Nominal voltage Un		6 V	12 V	24 V	48 V	200 V	200 V
Max. cont. operating voltage Uc		7 V	14 V	27 V	53 V	220 V	220 V
Maximum discharge current Imax (8/20)		10 kA	10 kA	10 kA	10 kA	10 kA	10 kA
Nominal discharge current In (8/20)		5 kA	5 kA	5 kA	5 kA	5 kA	5 kA
Voltage protection level Up at In		15 V	20 V	35 V	70 V	700 V	400 V
Response time		1 ns	1 ns	1 ns	1 ns	100 ns	1 ns
Rated current IL		140 mA	140 mA	140 mA	140 mA	-	140 mA
Series resistance		10 Ω	10 Ω	10 Ω	10 Ω	-	10 Ω
Cut frequency		10 MHz	2 MHz	4 MHz	6 MHz	100 MHz	3 MHz
Pluggable cartridge		Yes	Yes	Yes	Yes	Yes	Yes
State indicator		-	-	-	-	-	-
Safety reserve		No	No	No	No	No	No
Auxiliary contact (TS)		No	No	No	No	No	No
Installation							
Wire range (L, N, PE)	Solid wire	1.5...2.5 mm ²	1.5...2.5 mm ²	1.5...2.5 mm ²	1.5...2.5 mm ²	1.5...2.5 mm ²	1.5...2.5 mm ²
	Stranded wire	-	-	-	-	-	-
Stripping length (L, N, PE)		6...7 mm	6...7 mm	6...7 mm	6...7 mm	6...7 mm	6...7 mm
Tightening torque (L, N, PE)		0.2...0.4 Nm	0.2...0.4 Nm	0.2...0.4 Nm	0.2...0.4 Nm	0.2...0.4 Nm	0.2...0.4 Nm
Auxiliary contact (TS)							
Contact complement		-	-	-	-	-	-
Minimum load		-	-	-	-	-	-
Maximum load		-	-	-	-	-	-
Connection cross-section		-	-	-	-	-	-
Miscellaneous characteristics							
Stocking and operating temperature		-40...+80 °C	-40...+80 °C	-40...+80 °C	-40...+80 °C	-40...+80 °C	-40...+80 °C
Degree of protection		IP20	IP20	IP20	IP20	IP20	IP20
Fire resistance according to UL 94		V0	V0	V0	V0	V0	V0
Dimensions	mm	h x w x d 85 x 12 x 64 mm	85 x 12 x 64 mm	85 x 12 x 64 mm	85 x 12 x 64 mm	85 x 12 x 64 mm	85 x 12 x 64 mm
	inches	h x w x d 3.35 x 0.47 x 2.52 in	3.35 x 0.47 x 2.52 in	3.35 x 0.47 x 2.52 in	3.35 x 0.47 x 2.52 in	3.35 x 0.47 x 2.52 in	3.35 x 0.47 x 2.52 in
Replacement Cartridges							
Phase product ID	Type	OVR TC 06V C	OVR TC 12V C	OVR TC 24V C	OVR TC 48V C	OVR TC 200V C	OVR TC 200FR C
	Order code	2CTB804821R0000	2CTB804821R0100	2CTB804821R0200	2CTB804821R0300	2CTB804821R0400	2CTB804821R0500

Accessories for OVR Protection and safety

2

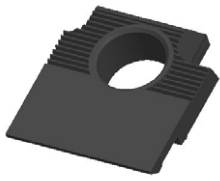

Accessory for cartridge lock

This accessory can be fitted into the front of the socket of the SPD to guarantee an even higher withstand to vibrations and shocks, it reinforces mechanical lock between the cartridges and the socket (they are already locked by the pins in the back of the cartridge). It's recommended for stressful environments as the nazelle of the wind turbines.

It's sold on packs of 50.

Description	Bbn 3660308	Type	Order code	Weight Pkg (1 pce) kg
Accessory for Cartridge Lock	-	SPD accessories	2CTB814355R1200	



Accessory for auxiliary contact lock

This accessory can be fitted into the top of the auxiliary contact module and guarantees an even higher withstand to stressful environments. It reinforces the mechanical lock between the auxiliary contact module and the socket of the SPD. It's recommended in environments where the cables of the auxiliary contact can suffer pulls due to the limited length of the auxiliary cables that restrict any potential movements.

It's sold on packs of 50.

Description	Bbn 3660308	Type	Order code	Weight Pkg (1 pce) kg
Accessory for auxiliary contact lock	-	SPD accessories	2CTB814355R2700	

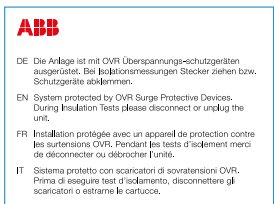

Label for surge protected installations

This label allows the user to identify the panels where surge protection devices are fitted. It's meant to be used in the inside of the panel door and clearly states that the cartridges need to be removed to perform insulation tests.

Description	Bbn 3660308	Type	Order code	Weight Pkg (1 pce) kg
Label for surge protected installations	-	SPD accessories	2CTB813860R1500	

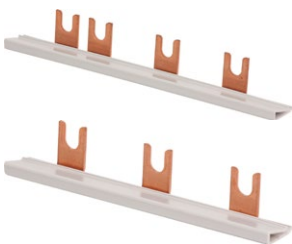

Bus bar

For TNC, IT, TNS or TT systems using single pole Type 1 SPDs assembled together, we have 2 different bus bars than can be used, as listed here below.

For TNS, TT (1Ph+N or 3Ph+N) or TNC (3Ph) systems for Type 1+2, Type 2, Type 2+3 SPDs, please refer to the "Busbar and accessories for MCBs S200, SN 201, RCDs F200 and DS 200 series".

Description	Bbn 3660308	Type	Order code	Weight Pkg (1 pce) kg
Busbar for Type 1, TT 3+1 configurations	516091	SPD accessories	2CTB815102R0400	0.03
Busbar for Type 1, TNC or IT 3-0 configurations	524751	SPD accessories	2CTB815141R0700	0.03

OVR surge protective devices – UL Version

[Products Standards, UL 1449](#) 104

[Selection tables](#) 107

[Ordering details and general technical data](#)

OVR Type 2 surge protective devices

Single pole	111
Delta networks	114
Single phase networks	117
Split phase networks	121
Grounded Wye networks	125

OVR for applications

OVR PV surge protective devices - Photovoltaic applications	129
OVR TC surge protective devices - Dataline protection	132

Products Standards, UL 1449

Terminology of SPD electrical characteristics

SPD terminology

8/20 wave:

Current waveform which passes through equipment when subjected to an overvoltage (low energy).

Type 2 surge protective device (SPD)

Permanently connected SPDs intended for installation on the load side of the service equipment overcurrent device, including SPDs located at a branch panel. It has successfully passed testing to the standard with the 8/20 wave (class II test).

Metal oxide varistor (MOV)

A varistor is an electronic component with a "diode like" non-linear current-voltage characteristic, used to protect circuits against excessive transient voltages. Most commonly composed of metal oxides.

Maximum continuous operating voltage (MCOV, U_c)

The maximum designated root mean square (rms) value of power frequency voltage that may be applied continuously between the terminals of the SPD.

Nominal discharge current (I_n)

Peak current value of an 8/20 waveform which the SPD is rated for based on the test program.

Maximum discharge current (I_{max})

Peak current value of an 8/20 waveform which can be safely discharged by the SPD, with an amplitude complying with the class II operating test sequence. $I_{max} > I_n$.

Short circuit current rating (SCCR)

Maximum symmetrical fault current, at rated voltage, that the SPD can withstand without sustaining damage that exceeds acceptable criteria or creates a hazardous operating condition.

Voltage protection rating (VPR)

The value of the VPR is determined as the nearest highest value, taken from Table 63.1 of ANSI/UL 1449 3rd Edition, to the measured limiting voltage determined during the transient voltage surge suppression test using the combination wave generator at a setting of 6 kV, 3 kA.

Voltage protection level (U_p or U_{res})

The voltage let through by the SPD while diverting surge current to ground must not exceed the voltage withstand value of the equipment connected downstream.

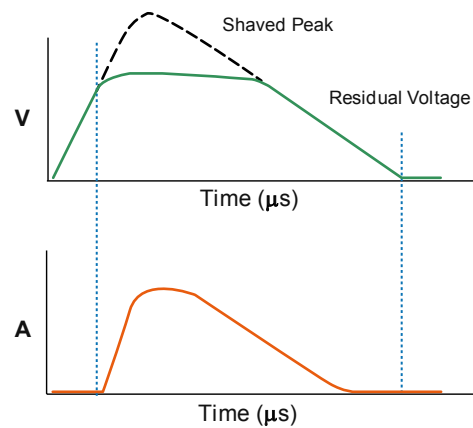

Notes:

Test wave 8/20 μs according to IEEE # C62.62-200/UL 1449
The first number corresponds to the time from 10% to 90% of its peak value (8 μs).

The second number corresponds to the time taken for the wave to descend to 50% of its peak value (20 μs).

UL 1449

The Underwriters Laboratories (UL) standard for surge protective devices (SPDs) has been the primary safety standard for surge protection since the first edition was published in 1985, and updated to the second edition in 1996.



The objective of UL 1449 has always been to increase safety in terms of surge protection.

Change in the standard's name: From TVSS to SPDs

Prior to UL 1449 3rd Edition taking effect, the devices this standard covers were known as Transient Voltage Surge Suppressors (TVSS), operating on power circuits not exceeding 600 V. With the inception of the 3rd Edition, these devices are now known as Surge Protective Devices (SPDs), and may operate on power circuits not exceeding 1500 V DC.

This new designation moves the UL standard closer to the international designation and to IEC standards. The new edition is now renamed UL Standard for Safety for Surge Protective Devices, UL 1449.

The different type designations of surge protective devices

The new UL 1449 3rd Edition places SPDs into five different Type categories based on installation location within an electrical system.

While Type 1, Type 2 and Type 3 categories refer to different types of SPDs that can be installed at specific locations, Type 4 and Type 5 categories refer to components used in an SPDs configuration.

Type 1 – "Permanently connected SPDs intended for installation between the secondary of the service transformer and the line side of the service equipment overcurrent device."

Type 2 – "Permanently connected SPDs intended for installation on the load side of the service equipment overcurrent device."

Type 3 – "Point of utilization SPDs, installed at a minimum conductor length of 10 meters (30 feet) from the electrical service panel."

Type 4 - Component assemblies – "Component assembly consisting of one or more Type 5 components together with a disconnect (integral or external) or a means of complying with the limited current tests."

Type 1, 2, 3 - Component assemblies – "Consists of a Type 4 component assembly with internal or external short circuit protection."

Type 5 – "Discrete component surge suppressors, such as MOVs that may be mounted on a PWB, connected by its leads or provided within an enclosure with mounting means and wiring terminations."

These new categories are by far the major changes applied to UL 1449 3rd Edition. SPDs installation location is now taken into account. The closer an SPD is installed to the equipment, the better the protection is. This is a push in the direction of providing stepped protection including external and internal surge protection.

The measured voltage protection level

One of the last changes found in the new UL 1449 3rd Edition, is the modification in the measured voltage protection level. The Measured Limiting Voltage (MLV) is the maximum magnitude of voltage measured at the application of a specific impulse wave shape.

When applying a certain surge current on the SPD the measured voltage at the device terminals is the so called "let-through voltage."

In UL 1449 2nd Edition, the let-through voltage was referred to as Suppressed Voltage Rating (SVR) and was calculated with a 0.5 kA surge wave form at 6 kV. The new designation is Voltage Protection Rating (VPR) and is calculated with a 3 kA surge wave form at 6 kV.

All products you will find in this chapter have been certified according to the UL 1449 3rd Edition.

The MLV will allow comparison of different types of SPDs with regards to the let-through voltage. However, it is important to note that the surge current used to measure the let-through voltage is six times higher in the 3rd Edition than in the 2nd Edition. This means that, comparing the obsolete SVR designation with the new VPR ratings will not be valid, as VPR ratings will of course be higher than SVR ratings.

UL 1449

List of OVR T2 UL products according to their certification

Type acc. To UL 1449 Ed3

Range	Type	Order code	Type 4 CA	Type 1 CA
T2 U	OVR T2 15-150 P U	2CTB802341R0000		●
	OVR T2 15-320 P U	2CTB802341R0400		●
	OVR T2 40-150 P U	2CTB802341R2000		●
	OVR T2 40-150 P TS U	2CTB802341R2100		●
	OVR T2 40-320 P U	2CTB802341R2400		●
	OVR T2 40-320 P TS U	2CTB802341R2500		●
	OVR T2 40-440 P TS U	2CTB802341R2900		●
	OVR T2 40-550 P TS U	2CTB802341R3300		●
	OVR T2 40-660 P TS U	2CTB802341R3700	●	
	OVR T2 70 N P U	2CTB802341R8000	●	
	OVR T2 1N 15-150 P U	2CTB802342R0000	●	
	OVR T2 1N 15-320 P U	2CTB802342R0400	●	
	OVR T2 1N 40-150 P U	2CTB802342R2000	●	
	OVR T2 1N 40-150 P TS U	2CTB802342R2100	●	
	OVR T2 1N 40-320 P TS U	2CTB802342R2500	●	
	OVR T2 1N 40-440 P TS U	2CTB802342R2900	●	
	OVR T2 1N 40-550 P TS U	2CTB802342R3300	●	
	OVR T2 1N 40-660 P TS U	2CTB802342R3700	●	
	OVR T2 2L 15-150 P U	2CTB802343R0000		●
	OVR T2 2L 15-320 P U	2CTB802343R0400		●
	OVR T2 2L 40-150 P TS U	2CTB802343R2100		●
	OVR T2 2L 40-320 P TS U	2CTB802343R2500		●
	OVR T2 2N 15-150 P U	2CTB802344R0000		●
	OVR T2 2N 15-320 P U	2CTB802344R0400	●	
	OVR T2 2N 40-150 P TS U	2CTB802344R2100	●	
	OVR T2 2N 40-320 P TS U	2CTB802344R2500	●	
	OVR T2 2N 40-440 P TS U	2CTB802344R2900	●	
	OVR T2 2N 40-550 P TS U	2CTB802344R3300	●	
	OVR T2 2N 40-660 P TS U	2CTB802344R3700	●	
	OVR T2 3L 15-150 P U	2CTB802345R0000		●
	OVR T2 3L 15-320 P U	2CTB802345R0400		●
	OVR T2 3L 40-150 P TS U	2CTB802345R2100		●
	OVR T2 3L 40-320 P TS U	2CTB802345R2500		●
	OVR T2 3L 40-440 P TS U	2CTB802345R2900		●
	OVR T2 3L 40-550 P TS U	2CTB802345R3300		●
	OVR T2 3N 15-150 P U	2CTB802346R0000	●	
	OVR T2 3N 15-320 P U	2CTB802346R0400	●	
	OVR T2 3N 40-150 P TS U	2CTB802346R2100	●	
	OVR T2 3N 40-320 P TS U	2CTB802346R2500	●	
	OVR T2 3N 40-440 P TS U	2CTB802346R2900	●	
	OVR T2 3N 40-550 P TS U	2CTB802346R3300	●	
	OVR T2 3N 40-660 P TS U	2CTB802346R3700	●	
	OVR T2 15-150 C U	2CTB802348R2500		●
	OVR T2 15-320 C U	2CTB802348R2700		●
	OVR T2 40-150 C U	2CTB802348R3500		●
	OVR T2 40-320 C U	2CTB802348R3700		●
	OVR T2 40-440 C U	2CTB802348R3900		●
	OVR T2 40-550 C U	2CTB802348R4100		●
	OVR T2 40-660 C U	2CTB802348R4300	●	
	OVR T2 70 N C U	2CTB802348R6500	●	

Type acc. To UL 1449 Ed3

Range	Type	Order code	Type 4 CA	Type 1 CA
PV U	OVR PV 40-600 P U	2CTB802340R0800		●
	OVR PV 40-600 P TS U	2CTB802340R0900		●
	OVR PV 40-800 P U	2CTB802340R2000		●
	OVR PV 40-800 P TS U	2CTB802340R2100		●
	OVR PV 40-1000 P U	2CTB802340R3200		●
	OVR PV 40-1000 P TS U	2CTB802340R3300		●
	OVR PV 15-600 P U	2CTB802340R5600		●
	OVR PV 15-600 P TS U	2CTB802340R5700		●
	OVR PV 15-800 P U	2CTB802340R6800		●
	OVR PV 15-800 P TS U	2CTB802340R6900		●
	OVR PV 15-1000 P U	2CTB802340R8000		●
	OVR PV 15-1000 P TS U	2CTB802340R8100		●
	OVR PV 40-600 C U	2CTB802349R0400		●
	OVR PV 40-800 C U	2CTB802349R1000		●
	OVR PV 40-1000 C U	2CTB802349R1600		●
	OVR PV 15-600 C U	2CTB802349R2900		●
	OVR PV 15-800 C U	2CTB802349R3500		●
	OVR PV 15-1000 C U	2CTB802349R4100		●

OVR surge protective devices – UL Version

Selection tables

Choosing the correct model

1) Determine the service voltage

Consult qualified personnel if the facility or operation service voltage is unknown.

2) Select the SPD maximum continuous operating voltage (MCOV, Uc)

The MCOV should correspond to the service voltage.

Example: If the service voltage is 480 V Delta, an SPD with 550 V or 660 V MCOV will be required.

Surge protection devices must also provide a level of protection compatible with the withstand voltage of the equipment.

This withstand voltage depends on the type of equipment and its sensitivity. The incoming surge protector may not provide adequate protection by itself, as certain electrical phenomena may greatly increase its residual voltage if cable lengths exceed 10 m. A second SPD may be necessary.

3) Select the SPD surge capacity (Imax)

Surge capacity is the amount of energy the SPD can withstand from a single surge event. The higher the surge capacity, the longer the device will protect the system. A second surge protector may be required if the surge capacity of the first is not capable of diverting all surge current to ground. See coordination below.

4) Remote monitoring (Optional)

Integrated auxiliary contact for remote monitoring available on models with "TS" designation.

Consult "Selection tables" on next page for help in the selection of SPDs.

Complete facility protection

Installing surge protection at the main distribution panel is only the beginning of protecting the entire operation. As most transient surges are created internally, it is necessary to install surge protection at sub-distribution panels (equipment protection) to be fully protected. Stepping down the I_{max} level from the service entrance panel toward equipment to be protected is recommended.

For example, if a 40 kA I_{max} SPD is installed in the main distribution panel, then 15 kA I_{max} SPDs should be installed in sub-distribution panels for equipment protection.

Coordination

It may be necessary to add a second surge protector, wired to the incoming unit, to achieve the required voltage protection and/or surge capacity. For Type 2 or 4 SPDs, installing this second unit a minimum of 1 m from the first unit will allow the two to work together, achieving the required protection.

Wiring rules

The impedance of the cables increases the voltage across the connected equipment. Therefore, the length of the cable between the surge protector and the equipment should be minimized.

The surge protective device should be installed as close to the equipment to be protected as possible. If this is not possible (the equipment is over 30 m from the panel), then a second surge protector must be installed.

OVR DIN rail SPD - Product type description

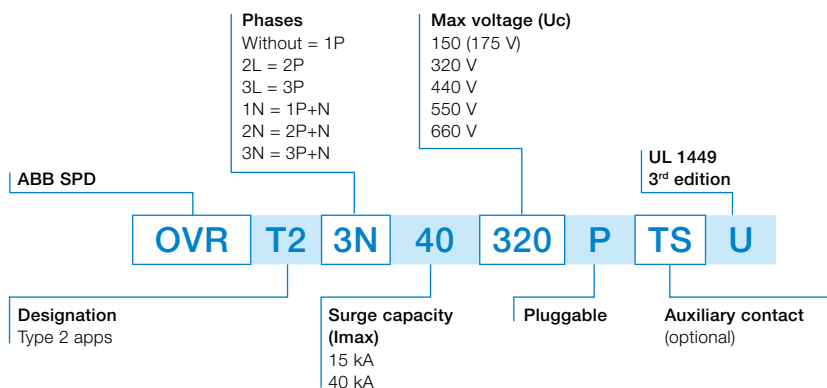

OVR surge protective devices – UL Version

Selection tables

General wiring diagrams - DIN rail devices

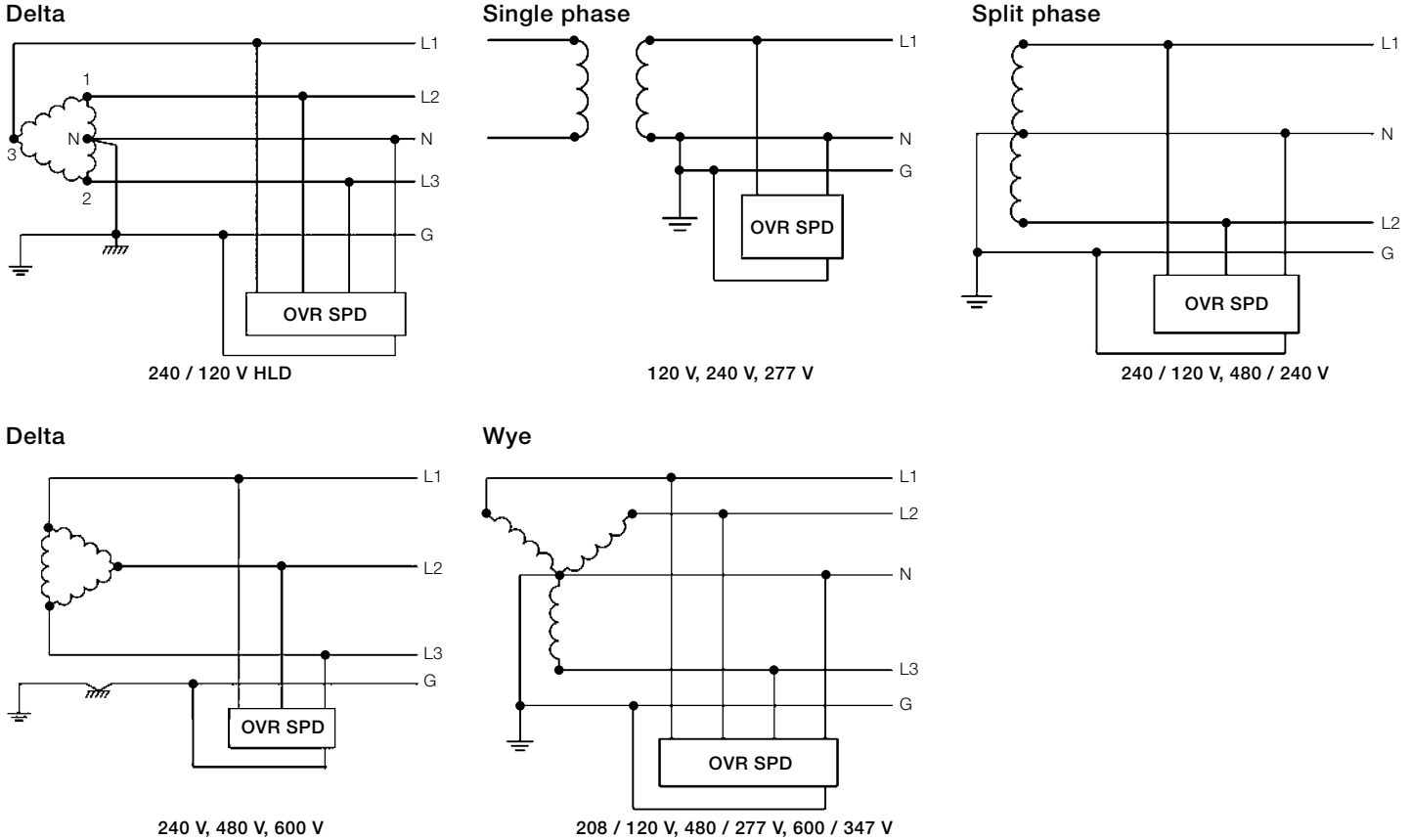

NOTE: Multiple pole SPDs shown. Wiring diagrams for reference only.

Protected lines	Impulse current limp 10/350 kA	Max. discharge current Imax 8/20 kA	Nominal discharge current In kA	Follow current interrupting rating Ifi kA	Voltage protection Rating VPR kV	Nominal voltage Un V	Max. cont. operating voltage MCOV V	Type	Order code
Type 2 - Pluggable - Single Pole networks									
1	-	15	5	-	0.6	120	150	OVR T2 15-150 P U	2CTB802341R0000
1	-	15	5	-	1	277 ±15%	320	OVR T2 15-320 P U	2CTB802341R0400
1	-	40	20	-	0.6	120	150	OVR T2 40-150 P U	2CTB802341R2000
1	-	40	20	-	0.6	120	150	OVR T2 40-150 P TS U	2CTB802341R2100
1	-	40	20	-	1	277 ±15%	320	OVR T2 40-320 P U	2CTB802341R2400
1	-	40	20	-	1	277 ±15%	320	OVR T2 40-320 P TS U	2CTB802341R2500
1	-	40	10	-	1.3	347 ±15%	440	OVR T2 40-440 P TS U	2CTB802341R2900
1	-	40	10	-	1.7	480 ±15%	550	OVR T2 40-550 P TS U	2CTB802341R3300
1	-	40	10	-	1.9	600 ±15%	660	OVR T2 40-660 P TS U	2CTB802341R3700
Neutral									
1	-	70	20	0.1	1.2	230	275	OVR T2 70 N P U	2CTB802341R8000
Cartridges									
1	-	-	-	-	-	120 ±15%	175	OVR T2 15-150 C U	2CTB802348R2500
1	-	-	-	-	-	277 ±15%	320	OVR T2 15-320 C U	2CTB802348R2700
1	-	-	-	-	-	120 ±15%	175	OVR T2 40-150 C U	2CTB802348R3500
1	-	-	-	-	-	277 ±15%	320	OVR T2 40-320 C U	2CTB802348R3700
1	-	-	-	-	-	347 ±15%	440	OVR T2 40-440 C U	2CTB802348R3900
1	-	-	-	-	-	480 ±15%	550	OVR T2 40-550 C U	2CTB802348R4100
1	-	-	-	-	-	600 ±15%	660	OVR T2 40-660 C U	2CTB802348R4300
1	-	-	-	-	-	230	275	OVR T2 70 N C U	2CTB802348R6500

2CTC43802450201

OVR surge protective devices – UL Version

Selection tables

Protected lines	Impulse current Iimp 10/350 kA	Max. discharge current Imax 8/20 kA	Nominal discharge current In kA	Follow current interrupting rating Ifi kA	Voltage protection Rating VPR kV	Nominal voltage Un V	Max. cont. operating voltage MCOV V	Type	Order code
-----------------	--------------------------------------	---	---------------------------------------	---	--	----------------------------	---	------	------------

Type 2 - Pluggable - Delta networks

3	–	15	5	–	1	277 ±15%	320	OVR T2 3L 15-320 P U	2CTB802345R0400
3	–	40	20	–	1	277 ±15%	320	OVR T2 3L 40-320 P TS U	2CTB802345R2500
3	–	40	10	–	1.7	480 ±15%	550	OVR T2 3L 40-550 P TS U	2CTB802345R3300

Cartridges

1	–	–	–	–	–	277 ±15%	320	OVR T2 15-320 C U	2CTB802348R2700
1	–	–	–	–	–	277 ±15%	320	OVR T2 40-320 C U	2CTB802348R3700
1	–	–	–	–	–	480 ±15%	550	OVR T2 40-550 C U	2CTB802348R4100

Type 2 - Pluggable - Single Phase networks

2	–	15	5	–	1.2	120	150	OVR T2 1N 15-150 P U	2CTB802342R0000
2	–	15	5	–	1.2	277	320	OVR T2 1N 15-320 P U	2CTB802342R0400
2	–	40	20	–	1.2	120	150	OVR T2 1N 40-150 P U	2CTB802342R2000
2	–	40	20	–	1.2	120	150	OVR T2 1N 40-150 P U (x10)	2CTB802342R8000
2	–	40	20	–	1.2	120	150	OVR T2 1N 40-150 P TS U	2CTB802342R2100
2	–	40	20	–	1.2	277	320	OVR T2 1N 40-320 P TS U	2CTB802342R2500
2	–	40	10	–	1.2	347	440	OVR T2 1N 40-440 P TS U	2CTB802342R2900
2	–	40	10	–	1.2	480	550	OVR T2 1N 40-550 P TS U	2CTB802342R3300
2	–	40	10	–	1.2	600	660	OVR T2 1N 40-660 P TS U	2CTB802342R3700

Cartridges

1	–	–	–	–	–	120 ±15%	175	OVR T2 15-150 C U	2CTB802348R2500
1	–	–	–	–	–	277 ±15%	320	OVR T2 15-320 C U	2CTB802348R2700
1	–	–	–	–	–	120 ±15%	175	OVR T2 40-150 C U	2CTB802348R3500
1	–	–	–	–	–	277 ±15%	320	OVR T2 40-320 C U	2CTB802348R3700
1	–	–	–	–	–	347 ±15%	440	OVR T2 40-440 C U	2CTB802348R3900
1	–	–	–	–	–	480 ±15%	550	OVR T2 40-550 C U	2CTB802348R4100
1	–	–	–	–	–	600 ±15%	660	OVR T2 40-660 C U	2CTB802348R4300

Type 2 - Pluggable - Split Phase networks

2	–	15	5	–	0.6	120 ±15%	175	OVR T2 2L 15-150 P U	2CTB802343R0000
2	–	15	5	–	1	277 ±15%	320	OVR T2 2L 15-320 P U	2CTB802343R0400
3	–	15	5	–	0.7	120 ±15%	175	OVR T2 2N 15-150 P U	2CTB802344R0000
3	–	15	5	–	1.1	277 ±15%	320	OVR T2 2N 15-320 P U	2CTB802344R0400
2	–	40	20	–	0.6	120 ±15%	175	OVR T2 2L 40-150 P TS U	2CTB802343R2100
2	–	40	20	–	1	277 ±15%	320	OVR T2 2L 40-320 P TS U	2CTB802343R2500
3	–	40	20	–	0.7	120 ±15%	175	OVR T2 2N 40-150 P TS U	2CTB802344R2100
3	–	40	20	–	1.1	277 ±15%	320	OVR T2 2N 40-320 P TS U	2CTB802344R2500
3	–	40	10	–	1.4	347 ±15%	440	OVR T2 2N 40-440 P TS U	2CTB802344R2900
3	–	40	10	–	1.8	480 ±15%	550	OVR T2 2N 40-550 P TS U	2CTB802344R3300
3	–	40	10	–	2	600 ±15%	660	OVR T2 2N 40-660 P TS U	2CTB802344R3700

Cartridges

1	–	–	–	–	–	120 ±15%	175	OVR T2 15-150 C U	2CTB802348R2500
1	–	–	–	–	–	277 ±15%	320	OVR T2 15-320 C U	2CTB802348R2700
1	–	–	–	–	–	120 ±15%	175	OVR T2 40-150 C U	2CTB802348R3500
1	–	–	–	–	–	277 ±15%	320	OVR T2 40-320 C U	2CTB802348R3700
1	–	–	–	–	–	347 ±15%	440	OVR T2 40-440 C U	2CTB802348R3900
1	–	–	–	–	–	480 ±15%	550	OVR T2 40-550 C U	2CTB802348R4100

Type 2 - Pluggable - Grounded Wye networks

3	–	15	5	–	0.6	120 ±15%	175	OVR T2 3L 15-150 P U	2CTB802345R0000
4	–	15	5	–	0.6	120 ±15%	175	OVR T2 3N 15-150 P U	2CTB802346R0000
4	–	15	5	–	1.2	277 ±15%	320	OVR T2 3N 15-320 P U	2CTB802346R0400
3	–	40	20	–	0.6	120 ±15%	175	OVR T2 3L 40-150 P TS U	2CTB802345R2100
3	–	40	10	–	1.3	347 ±15%	440	OVR T2 3L 40-440 P TS U	2CTB802345R2900
4	–	40	20	–	1.2	120 ±15%	175	OVR T2 3N 40-150 P TS U	2CTB802346R2100
4	–	40	20	–	1.2	277 ±15%	320	OVR T2 3N 40-320 P TS U	2CTB802346R2500
4	–	40	10	–	1.2	347 ±15%	440	OVR T2 3N 40-440 P TS U	2CTB802346R2900
4	–	40	10	–	1.2	480 ±15%	550	OVR T2 3N 40-550 P TS U	2CTB802346R3300
4	–	40	10	–	1.2	600 ±15%	660	OVR T2 3N 40-660 P TS U	2CTB802346R3700

Cartridges

1	–	–	–	–	–	120 ±15%	175	OVR T2 15-150 C U	2CTB802348R2500
1	–	–	–	–	–	120 ±15%	175	OVR T2 40-150 C U	2CTB802348R3500
1	–	–	–	–	–	347 ±15%	440	OVR T2 40-440 C U	2CTB802348R3900
1	–	–	–	–	–	277 ±15%	320	OVR T2 15-320 C U	2CTB802348R2700
1	–	–	–	–	–	277 ±15%	320	OVR T2 40-320 C U	2CTB802348R3700
1	–	–	–	–	–	480 ±15%	550	OVR T2 40-550 C U	2CTB802348R4100
1	–	–	–	–	–	600 ±15%	660	OVR T2 40-660 C U	2CTB802348R4300

OVR surge protective devices – UL Version

Selection tables

Protected lines	Impulse current Iimp 10/350 kA	Max. discharge current Imax 8/20 kA	Nominal discharge current In kA	Short circuit withstand Isscr/Iscpv kA	Voltage protection Rating VPR kV	Nominal voltage Un V	Max. cont. operating voltage Uc V DC	Type	Order code
Type 2 - Pluggable - Photovoltaic applications									
2	-	15	5	1	3	600	670	OVR PV 15-600 P U	2CTB802340R5600
2	-	15	5	1	3	600	670	OVR PV 15-600 P TS U	2CTB802340R5700
2	-	40	10	1	3	600	670	OVR PV 40-600 P U	2CTB802340R0800
2	-	40	10	1	3	600	670	OVR PV 40-600 P TS U	2CTB802340R0900
2	-	15	5	1	4	800	1000	OVR PV 15-800 P U	2CTB802340R6800
2	-	15	5	1	4	800	1000	OVR PV 15-800 P TS U	2CTB802340R6900
2	-	40	10	1	4	800	1000	OVR PV 40-800 P U	2CTB802340R2000
2	-	40	10	1	4	800	1000	OVR PV 40-800 P TS U	2CTB802340R2100
2	-	15	5	1	4	1000	1250	OVR PV 15-1000 P U	2CTB802340R8000
2	-	15	5	1	4	1000	1250	OVR PV 15-1000 P TS U	2CTB802340R8100
2	-	40	10	1	4	1000	1250	OVR PV 40-1000 P U	2CTB802340R3200
2	-	40	10	1	4	1000	1250	OVR PV 40-1000 P TS U	2CTB802340R3300
2	2	40	15	1	4.5	1500	1500	OVR PV 40-1500H P U	2CTB802340R4200
2	2	40	15	1	4.5	1500	1500	OVR PV 40-1500H P TS U	2CTB802340R4300
Cartridges									
-	-	-	-	-	-	600	670	OVR PV 15-600 C U	2CTB802349R2900
-	-	-	-	-	-	600	670	OVR PV 40-600 C U	2CTB802349R0400
-	-	-	-	-	-	800	1000	OVR PV 15-800 C U	2CTB802349R3500
-	-	-	-	-	-	800	1000	OVR PV 40-800 C U	2CTB802349R1000
-	-	-	-	-	-	1000	1250	OVR PV 15-1000 C U	2CTB802349R4100
-	-	-	-	-	-	1000	1250	OVR PV 40-1000 C U	2CTB802349R1600
-	-	-	-	-	-	1500	1500	OVR PV 40-1500H C U	2CTB802349R1700
Dataline protection - Pluggable									
1	-	10	5	-	300	200	220	OVR TC 200FR US	2CTB811814R0000
1	-	10	5	-	15	6	7	OVR TC 06V US	2CTB811814R0100
1	-	10	5	-	20	12	14	OVR TC 12V US	2CTB811814R0200
1	-	10	5	-	35	24	27	OVR TC 24V US	2CTB811814R0300
1	-	10	5	-	70	48	53	OVR TC 48V US	2CTB811814R0400

OVR Type 2 surge protective devices - Single pole



OVR T2 40-150 P U



OVR T2 40-440 P TS U



OVR T2 70 N P U

Description

Single pole devices provide great flexibility for any kind of network configuration.

OVR T2 devices provide the best protection as they are designed to protect electric installations and sensitive equipment against indirect surges with ensuring a low protection level (VPR). They are characterized by their capacity to safely discharge current with 8/20 μ s wave form.

Ordering details

Pro- tected lines	Max dis- charge current I_{max} 8/20 kA	Nominal dis- charge current I_n kA	Voltage protec- tion rating VPR kV	Nominal voltage U_n V	Max. cont. operating voltage MCOV V	Bbn 3660308 EAN	Type	Order code	Weight Pkg (1 pce) kg
-------------------------	---	---	---	----------------------------------	--	-----------------------	------	------------	--------------------------------

Pluggable

1	15	5	0.6	120	150	518514	OVR T2 15-150 P U	2CTB802341R0000	0.12
1	15	5	1	277 $\pm 15\%$	320	518521	OVR T2 15-320 P U	2CTB802341R0400	0.12
1	40	20	0.6	120	150	518958	OVR T2 40-150 P U	2CTB802341R2000	0.12
1	40	20	0.6	120	150	518958	OVR T2 40-150 P TS U	2CTB802341R2100	0.12
1	40	20	1	277 $\pm 15\%$	320	518965	OVR T2 40-320 P U	2CTB802341R2400	0.12
1	40	20	1	277 $\pm 15\%$	320	518545	OVR T2 40-320 P TS U	2CTB802341R2500	0.12
1	40	10	1.3	347 $\pm 15\%$	440	518552	OVR T2 40-440 P TS U	2CTB802341R2900	0.12
1	40	10	1.7	480 $\pm 15\%$	550	518569	OVR T2 40-550 P TS U	2CTB802341R3300	0.12
1	40	10	1.9	600 $\pm 15\%$	660	518576	OVR T2 40-660 P TS U	2CTB802341R3700	0.12

Neutral - Pluggable

1	70	20	1.2	230	275	518583	OVR T2 70 N P U	2CTB802341R8000	0.12
---	----	----	-----	-----	-----	--------	-----------------	-----------------	------

Main dimensions mm

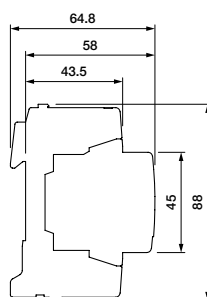

OVR T2 15-150 P U
OVR T2 15-320 P U
OVR T2 40-150 P U
OVR T2 40-320 P U

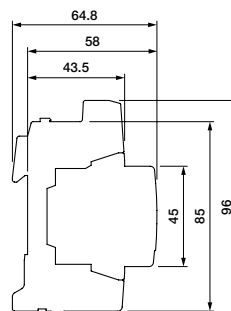

OVR T2 40-150 P TS U
OVR T2 40-320 P TS U
OVR T2 40-440 P TS U
OVR T2 40-550 P TS U
OVR T2 40-660 P TS U

Type	Width mm
OVR T2 15-150 P U	17.8
OVR T2 15-320 P U	17.8
OVR T2 40-150 P U	17.8
OVR T2 40-150 P TS U	17.8
OVR T2 40-320 P U	17.8
OVR T2 40-320 P TS U	17.8
OVR T2 40-440 P TS U	17.8
OVR T2 40-550 P TS U	17.8
OVR T2 40-660 P TS U	17.8
OVR T2 70 N P U	17.8

OVR Type 2 surge protective devices - Single pole



General technical data

Type	OVR T2 15-150 P U	OVR T2 15-320 P U	OVR T2 40-150 P U
with auxiliary contact (TS)	–	–	OVR T2 40-150 P TS U
Technology	Varistor	Varistor	Varistor
Electrical features			
Standard	UL 1449	UL 1449	UL 1449
Type / test class (UL 1449)	1	1	1
Protected lines	1	1	1
System network	–	–	–
Type of current / frequency	AC 47-63 Hz	AC 47-63 Hz	AC 47-63 Hz
Voltage regulation of the system network	±15%	±15%	±15%
Nominal system voltage Un	120 V	277 V ±15%	120 V
Maximum continuous operating voltage MCOV	150 V	320 V	150 V
Maximal discharge current (8/20) Imax	15 kA	15 kA	40 kA
Nominal discharge current (8/20) In	5 kA	5 kA	20 kA
Voltage protection rating (L-N / N-G / L-G) VPR	0.6 kV	1 kV	0.6 kV
Response time	< 25 ns	< 25 ns	< 25 ns
Short circuit withstand SCCR	200 kA	200 kA	200 kA
Back up protection fuse (gG - gL)	≤ 100 A	≤ 100 A	≤ 100 A
maximum rating circuit breaker (B or C Curve)	≤ 125 A	≤ 125 A	≤ 125 A
Pluggable cartridges	Yes	Yes	Yes
Integrated QuickSafe® technology	Yes	Yes	Yes
State indicator	Yes	Yes	Yes
Safety reserve	–	–	–
Auxiliary contact (TS)	No	No	Yes (TS option)
Installation			
Wire range (L,N,PE) solid wire	2.5...25 / 4...14 mm ²	2.5...25 / 4...14 mm ²	2.5...25 / 4...14 mm ²
stranded wire	2.5...16 / 6...14 mm ²	2.5...16 / 6...14 mm ²	2.5...16 / 6...14 mm ²
Stripping length (L,N,PE)	12.5 / 0.5 mm	12.5 / 0.5 mm	12.5 / 0.5 mm
Tightening torque (L,N,PE)	2.8 / 24.5 Nm	2.8 / 24.5 Nm	2.8 / 24.5 Nm
Auxiliary contact (TS)			
Contact information	–	–	1 NO – 1 NC
Min. load	–	–	12 V DC – 10 mA
Max. load	–	–	250 V AC – 1 A
Connection cross section	–	–	1.5 / 16 mm ²
Miscellaneous characteristics			
Stocking temperature	-40...+80 °C	-40...+80 °C	-40...+80 °C
Operating temperature	-40...+176 °C	-40...+176 °C	-40...+176 °C
Degree of protection	NEMA 1	NEMA 1	NEMA 1
Fire resistance according to UL 94	V0	V0	V0
Dimensions	mm h x w x d 88 x 17.8 x 64.8 mm	mm h x w x d 88 x 17.8 x 64.8 mm	mm h x w x d 88 x 17.8 x 64.8 mm
	inches h x w x d 3.46 x 0.7 x 2.55 in	inches h x w x d 3.46 x 0.7 x 2.55 in	inches h x w x d 3.46 x 0.7 x 2.55 in
Dimensions with auxiliary contact (TS)	mm h x w x d –	mm h x w x d –	mm h x w x d 96 x 17.8 x 64.8 mm
	inches h x w x d –	inches h x w x d –	inches h x w x d 3.78 x 0.7 x 2.55 in
Replacement cartridges			
Phase product ID	Type OVR T2 15-150 C U	Type OVR T2 15-320 C U	Type OVR T2 40-150 C U
Order code	2CTB802348R2500	2CTB802348R2700	2CTB802348R3500
Neutral product ID	Type –	Type –	Type –
Order code	–	–	–

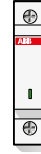

OVR T2 40-320 P U OVR T2 40-320 P TS U	- OVR T2 40-440 P TS U	- OVR T2 40-550 P TS U	- OVR T2 40-660 P TS U	OVR T2 70 N P U
Varistor	Varistor	Varistor	Varistor	Spark gap
UL 1449	UL 1449	UL 1449	UL 1449	UL 1449
1	1	1	1	4
1	1	1	1	1
-	-	-	-	-
AC 47-63 Hz	AC 47-63 Hz	AC 47-63 Hz	AC 47-63 Hz	AC 47-63 Hz
±15%	±15%	±15%	±15%	+15%
277 V ±15%	347 V ±15%	480 V ±15%	600 V ±15%	230 V
320 V	440 V	550 V	660 V	275 V
40 kA	40 kA	40 kA	40 kA	70 kA
20 kA	10 kA	10 kA	10 kA	20 kA
1 kV	1.3 kV	1.7 kV	1.9 kV	1.2 kV
< 25 ns	< 25 ns	< 25 ns	< 25 ns	< 25 ns
200 kA	200 kA	200 kA	200 kA	200 kA
≤ 100 A	≤ 100 A	≤ 100 A	≤ 100 A	≤ 100 A
≤ 125 A	≤ 125 A	≤ 125 A	≤ 125 A	≤ 125 A
Yes	Yes	Yes	Yes	Yes
Yes	Yes	Yes	Yes	No
Yes	Yes	Yes	Yes	Yes
-	-	-	-	-
Yes (TS option)	Yes	Yes	Yes	No
2.5...25 / 4...14 mm ²	2.5...25 / 4...14 mm ²	2.5...25 / 4...14 mm ²	2.5...25 / 4...14 mm ²	2.5...25 / 4...14 mm ²
2.5...16 / 6...14 mm ²	2.5...16 / 6...14 mm ²	2.5...16 / 6...14 mm ²	2.5...16 / 6...14 mm ²	2.5...16 / 6...14 mm ²
12.5 / 0.5 mm	12.5 / 0.5 mm	12.5 / 0.5 mm	12.5 / 0.5 mm	12.5 / 0.5 mm
2.8 / 24.5 Nm	2.8 / 24.5 Nm	2.8 / 24.5 Nm	2.8 / 24.5 Nm	2.8 / 24.5 Nm
1 NO – 1 NC	1 NO – 1 NC	1 NO – 1 NC	1 NO – 1 NC	-
12 V DC – 10 mA	12 V DC – 10 mA	12 V DC – 10 mA	12 V DC – 10 mA	-
250 V AC – 1 A	250 V AC – 1 A	250 V AC – 1 A	250 V AC – 1 A	-
1.5 / 16 mm ²	1.5 / 16 mm ²	1.5 / 16 mm ²	1.5 / 16 mm ²	-
-40...+80 °C	-40...+80 °C	-40...+80 °C	-40...+80 °C	-40...+80 °C
-40...+176 °C	-40...+176 °C	-40...+176 °C	-40...+176 °C	-40...+176 °C
NEMA 1	NEMA 1	NEMA 1	NEMA 1	NEMA 1
V0	V0	V0	V0	V0
88 x 17.8 x 64.8 mm	-	-	-	88 x 17.8 x 64.8 mm
3.46 x 0.7 x 2.55 in	-	-	-	3.46 x 0.7 x 2.55 in
96 x 17.8 x 64.8 mm	96 x 17.8 x 64.8 mm	96 x 17.8 x 64.8 mm	96 x 17.8 x 64.8 mm	-
3.78 x 0.7 x 2.55 in	3.78 x 0.7 x 2.55 in	3.78 x 0.7 x 2.55 in	3.78 x 0.7 x 2.55 in	-
OVR T2 40-320 C U	OVR T2 40-440 C U	OVR T2 40-550 C U	OVR T2 40-660 C U	-
2CTB802348R3700	2CTB802348R3900	2CTB802348R4100	2CTB802348R4300	-
-	-	-	-	OVR T2 70 N C U
-	-	-	-	2CTB802348R6500

OVR Type 2 surge protective devices Delta networks



2CTC432131F1701

OVR T2 3L 15-320 P U



2CTC432133F1701

OVR T2 3L 40-320 P TS U

Description

Delta devices provide the protection required by the three phases of a Delta network system.

OVR T2 devices provide the best protection as they are designed to protect electric installations and sensitive equipment against indirect surges with ensuring a low protection level (VPR). They are characterized by their capacity to safely discharge current with 8/20 μ s wave form.

Ordering details

Protected lines	Max discharge current I_{max} 8/20 kA	Nominal discharge current I_n kA	Voltage protection rating VPR kV	Nominal voltage U_n V	Max. cont. operating voltage MCOV, U_c V	Bbn 3660308 EAN	Type	Order code	Weight Pkg (1 pce) kg
-----------------	---	------------------------------------	----------------------------------	-------------------------	--	-----------------	------	------------	-----------------------

Pluggable

3	15	5	1	277 \pm 15%	320	518644	OVR T2 3L 15-320 P U	2CTB802345R0400	0.36
3	40	20	1	277 \pm 15%	320	518668	OVR T2 3L 40-320 P TS U	2CTB802345R2500	0.36
3	40	10	1.7	480 \pm 15%	550	518682	OVR T2 3L 40-550 P TS U	2CTB802345R3300	0.36

Type	Width mm
OVR T2 3L 15-320 P U	53.4
OVR T2 3L 40-320 P TS U	53.4
OVR T2 3L 40-550 P TS U	53.4

Main dimensions mm

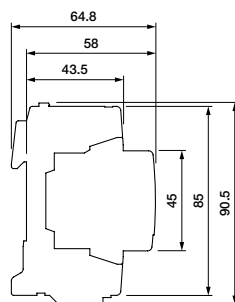

OVR T2 3L 15-320 P U

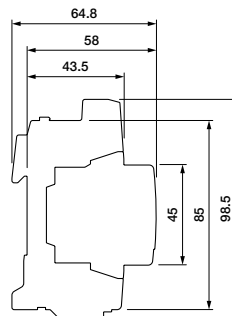

OVR T2 3L 40-320 P TS U
OVR T2 3L 40-550 P TS U

OVR Type 2 surge protective devices

Delta networks

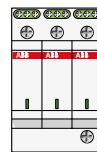
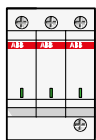

General technical data

Type	OVR T2 3L 15-320 P U		-	-
with auxiliary contact (TS)	-		OVR T2 3L 40-320 P TS U	OVR T2 3L 40-550 P TS U
Electrical features				
Standards	UL 1449		UL 1450	UL 1451
Type / test class (UL 1449)	1		1	1
Protected lines	3		3	3
Type of current / frequency	AC 47-63 Hz		AC 47-63 Hz	AC 47-63 Hz
Voltage regulation of the system network	±15%		±15%	±15%
Nominal system voltage Un	277 V ±15%		277 V ±15%	480 V ±15%
Maximum continuous operating voltage MCOV	320 V		320 V	550 V
Maximal discharge current (8/20) Imax	15 kA		40 kA	40 kA
Nominal discharge current (8/20) In	5 kA		20 kA	10 kA
Voltage protection rating (L-N / N-G / L-G) VPR	1 kV		1 kV	1.7 kV
Response time	< 25 ns		< 25 ns	< 25 ns
Short circuit withstand SCCR	200 kA		200 kA	200 kA
Back up protection fuse (gG - gL) maximum rating	≤ 100 A		≤ 100 A	≤ 100 A
circuit breaker (B or C curve)	≤ 125 A		≤ 125 A	≤ 125 A
Pluggable cartridges	Yes		Yes	Yes
Integrated QuickSafe® technology	Yes		Yes	Yes
State indicator	Yes		Yes	Yes
Safety reserve	-		-	-
Auxiliary contact (TS)	No		Yes	Yes
Installation				
Wire range (L,N,PE)	solid wire	2.5...25 / 4...14 mm ²	2.5...25 / 4...14 mm ²	2.5...25 / 4...14 mm ²
	stranded wire	2.5...16 / 6...14 mm ²	2.5...16 / 6...14 mm ²	2.5...16 / 6...14 mm ²
Stripping length (L,N,PE)	12.5 / 0.5 mm		12.5 / 0.5 mm	12.5 / 0.5 mm
Tightening torque (L,N,PE)	2.8 / 24.5 Nm		2.8 / 24.5 Nm	2.8 / 24.5 Nm
Auxiliary contact (TS)				
Contact information	-		3 NO - 3 NC	3 NO - 3 NC
Min. load	-		12 V DC - 10 mA	12 V DC - 10 mA
Max. load	-		250 V AC - 1 A	250 V AC - 1 A
Connection cross section	-		1.5 / 16 mm ²	1.5 / 16 mm ²
Miscellaneous characteristics				
Stocking temperature	-40...+80 °C		-40...+80 °C	-40...+80 °C
Operating temperature	-40...+176 °C		-40...+176 °C	-40...+176 °C
Degree of protection	NEMA 1		NEMA 1	NEMA 1
Fire resistance according to UL 94	V0		V0	V0
Dimensions	mm	h x w x d 90.5 x 53.4 x 64.8 mm	-	-
	inches	h x w x d 3.56 x 2.1 x 2.55 in	-	-
Dimensions with auxiliary contact (TS)	mm	h x w x d -	98.5 x 53.4 x 64.8 mm	98.5 x 53.4 x 64.8 mm
	inches	h x w x d -	3.88 x 2.1 x 2.55 in	3.88 x 2.1 x 2.55 in
Replacement cartridges				
Phase product ID	Type	OVR T2 15-320 C U	OVR T2 40-320 C U	OVR T2 40-550 C U
	Order code	2CTB802348R2700	2CTB802348R3700	2CTB802348R4100
Neutral product ID	Type	-	-	-
	Order code	-	-	-

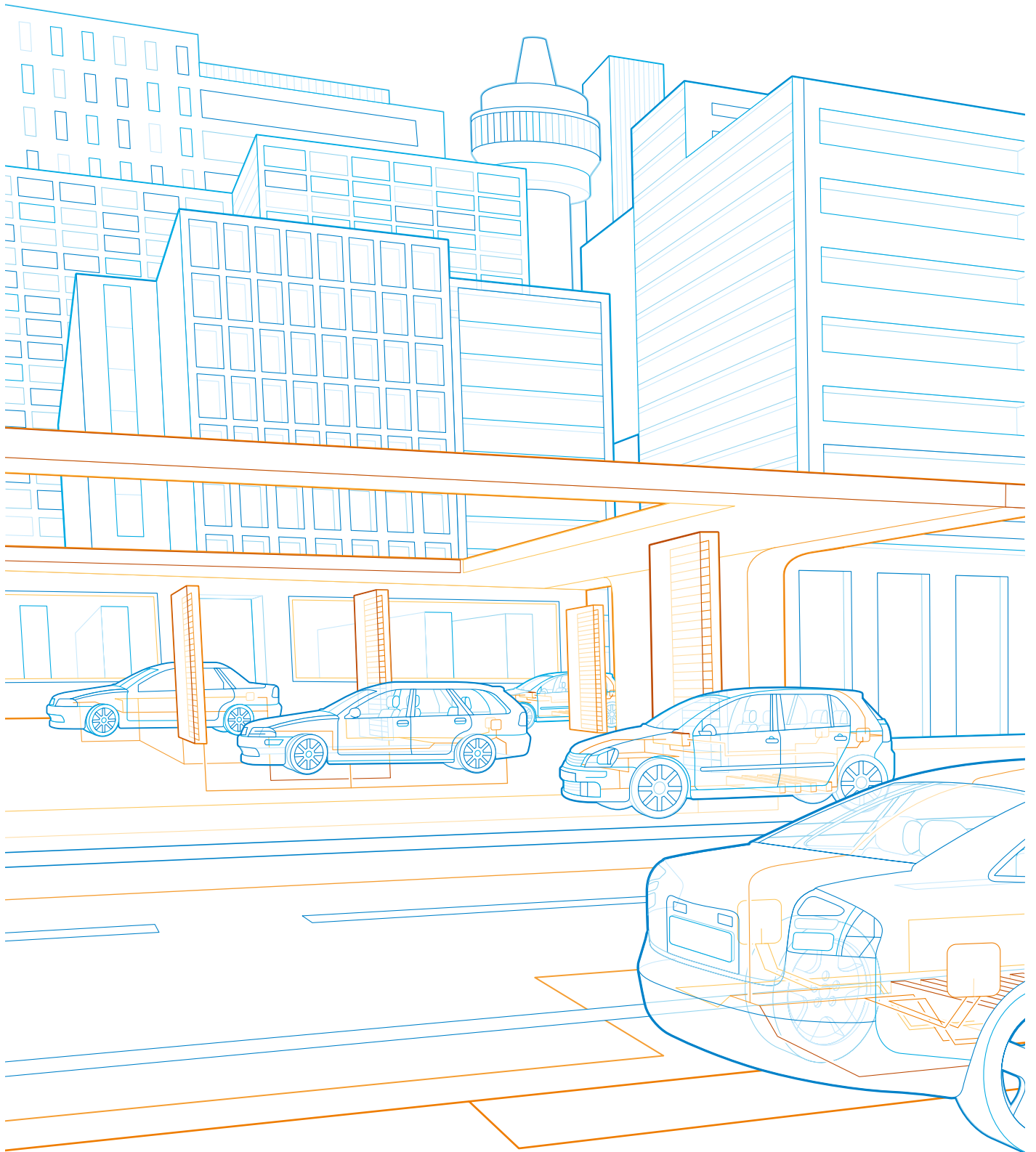

OVR Type 2 surge protective devices

Single phase networks



OVR T2 1N 40-150 P U



OVR T2 1N 40-660 P TS U

Description

Single phase devices are composed by a MOV pole plus a spark gap one. The spark gap pole guarantees the lowest voltage protection rating and has to be connected to the Neutral.

OVR T2 devices provide the best protection as they are designed to protect electric installations and sensitive equipment against indirect surges with ensuring a low protection level (VPR). They are characterized by their capacity to safely discharge current with 8/20 μ s wave form.

Ordering details

Protected lines	Max discharge current I _{max} 8/20 kA	Nominal discharge current I _n kA	Voltage protection rating VPR kV	Nominal voltage U _n V	Max. cont. operating voltage MCOV, U _c V	Bbn 3660308 EAN	Type	Order code	Weight Pkg (1 pce) kg
-----------------	--	---	----------------------------------	----------------------------------	---	-----------------	------	------------	-----------------------

Pluggable

2	15	5	1.2	120	150	519238	OVR T2 1N 15-150 P U	2CTB802342R0000	0.24
2	15	5	1.2	277	320	519245	OVR T2 1N 15-320 P U	2CTB802342R0400	0.24
2	40	20	1.2	120	150	520869	OVR T2 1N 40-150 P U	2CTB802342R2000	0.24
2	40	20	1.2	120	150	520876	OVR T2 1N 40-150 P U (x10)	2CTB802342R8000	0.24
2	40	20	1.2	120	150	819252	OVR T2 1N 40-150 P TS U	2CTB802342R2100	0.24
2	40	20	1.2	277	320	519269	OVR T2 1N 40-320 P TS U	2CTB802342R2500	0.24
2	40	10	1.2	347	440	519276	OVR T2 1N 40-440 P TS U	2CTB802342R2900	0.24
2	40	10	1.2	480	550	519283	OVR T2 1N 40-550 P TS U	2CTB802342R3300	0.24
2	40	10	1.2	600	660	519290	OVR T2 1N 40-660 P TS U	2CTB802342R3700	0.24

(x10) packaging of 10 pieces.

Main dimensions mm

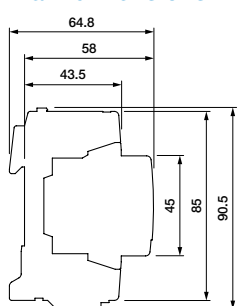

OVR T2 1N 15-150 P U
OVR T2 1N 15-320 P U
OVR T2 1N 40-150 P U

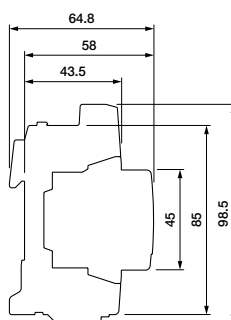

OVR T2 1N 40-150 P TS U
OVR T2 1N 40-320 P TS U
OVR T2 1N 40-440 P TS U
OVR T2 1N 40-550 P TS U
OVR T2 1N 40-660 P TS U

Type	Width mm
OVR T2 1N 15-150 P U	35.6
OVR T2 1N 15-320 P U	35.6
OVR T2 1N 40-150 P U	35.6
OVR T2 1N 40-150 P TS U	35.6
OVR T2 1N 40-320 P TS U	35.6
OVR T2 1N 40-440 P TS U	35.6
OVR T2 1N 40-550 P TS U	35.6
OVR T2 1N 40-660 P TS U	35.6

OVR Type 2 surge protective devices

Single phase networks

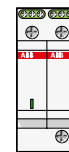
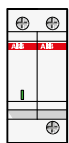

General technical data

		OVR T2 1N 15-150 P U	OVR T2 1N 15-320 P U	OVR T2 1N 40-150 P U	OVR T2 1N 40-150 P TS U
Type		OVR T2 1N 15-150 P U	OVR T2 1N 15-320 P U	OVR T2 1N 40-150 P U	OVR T2 1N 40-150 P TS U
with auxiliary contact (TS)		–	–	–	–
Electrical features					
Standards		UL 1449	UL 1449	UL 1449	UL 1449
Type / test class (UL 1449)		4	4	4	4
Protected lines		2	2	2	2
Type of current / frequency		AC 47-63 Hz	AC 47-63 Hz	AC 47-63 Hz	AC 47-63 Hz
Voltage regulation of the system network		±15%	±15%	±15%	±15%
Nominal system voltage Un		120 V	277 V	120 V	120 V
Maximum continuous operating voltage MCOV		150 V	320 V	150 V	150 V
Maximal discharge current (8/20) Imax		15 kA	15 kA	40 kA	40 kA
Nominal discharge current (8/20) In		5 kA	5 kA	20 kA	20 kA
Voltage protection rating (L-N / N-G / L-G) VPR		1.2 kV	1.2 kV	1.2 kV	1.2 kV
Response time		< 25 ns	< 25 ns	< 25 ns	< 25 ns
Short circuit withstand SCCR		200 kA	200 kA	200 kA	200 kA
Back up protection fuse (gG - gL)		≤ 100 A	≤ 100 A	≤ 100 A	≤ 100 A
maximum rating circuit breaker (B or C curve)		≤ 125 A	≤ 125 A	≤ 125 A	≤ 125 A
Pluggable cartridges		Yes	Yes	Yes	Yes
Integrated QuickSafe® technology		Yes	Yes	Yes	Yes
State indicator		Yes	Yes	Yes	Yes
Safety reserve		–	–	–	–
Auxiliary contact (TS)		No	No	No	Yes (TS option)
Installation					
Wire range (L,N,PE)	solid wire	2.5...25 / 4...14 mm ²	2.5...25 / 4...14 mm ²	2.5...25 / 4...14 mm ²	2.5...25 / 4...14 mm ²
	stranded wire	2.5...16 / 6...14 mm ²	2.5...16 / 6...14 mm ²	2.5...16 / 6...14 mm ²	2.5...16 / 6...14 mm ²
Stripping length (L,N,PE)		12.5 / 0.5 mm	12.5 / 0.5 mm	12.5 / 0.5 mm	12.5 / 0.5 mm
Tightening torque (L,N,PE)		2.8 / 24.5 Nm	2.8 / 24.5 Nm	2.8 / 24.5 Nm	2.8 / 24.5 Nm
Auxiliary contact (TS)					
Contact information				2 NO – 2 NC	
Min. load				12 V DC – 10 mA	
Max. load				250 V AC – 1 A	
Connection cross section				1.5 / 16 mm ²	
Miscellaneous characteristics					
Stocking temperature		-40...+80 °C	-40...+80 °C	-40...+80 °C	-40...+80 °C
Operating temperature		-40...+176 °C	-40...+176 °C	-40...+176 °C	-40...+176 °C
Degree of protection		NEMA 1	NEMA 1	NEMA 1	NEMA 1
Fire resistance according to UL 94		V0	V0	V0	V0
Dimensions	mm	h x w x d 90.5 x 35.6 x 64.8 mm	90.5 x 35.6 x 64.8 mm	90.5 x 35.6 x 64.8 mm	90.5 x 35.6 x 64.8 mm
	inches	h x w x d 3.56 x 1.4 x 2.55 in	3.56 x 1.4 x 2.55 in	3.56 x 1.4 x 2.55 in	3.56 x 1.4 x 2.55 in
Dimensions with auxiliary contact (TS)	mm	h x w x d –	–	98.5 x 35.6 x 64.8 mm	98.5 x 35.6 x 64.8 mm
	inches	h x w x d –	–	3.88 x 1.4 x 2.55 in	3.88 x 1.4 x 2.55 in
Replacement cartridges					
Phase product ID	Type	OVR T2 15-150 C U	OVR T2 15-320 C U	OVR T2 40-150 C U	OVR T2 40-150 C U
	Order code	2CTB802348R2500	2CTB802348R2700	2CTB802348R3500	2CTB802348R3500
Neutral product ID	Type	OVR T2 70 N C U	OVR T2 70 N C U	OVR T2 70 N C U	OVR T2 70 N C U
	Order code	2CTB802348R6500	2CTB802348R6500	2CTB802348R6500	2CTB802348R6500

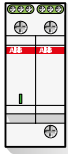

OVR T2 1N 40-320 P TS U	OVR T2 1N 40-440 P TS U	OVR T2 1N 40-550 P TS U	OVR T2 1N 40-660 P TS U
UL 1449	UL 1449	UL 1449	UL 1449
4	4	4	4
2	2	2	2
AC 47-63 Hz	AC 47-63 Hz	AC 47-63 Hz	AC 47-63 Hz
±15%	±15%	±15%	±15%
277 V	347 V	480 V	600 V
320 V	440 V	550 V	660 V
40 kA	40 kA	40 kA	40 kA
20 kA	10 kA	10 kA	10 kA
1.2 kV	1.2 kV	1.2 kV	1.2 kV
< 25 ns	< 25 ns	< 25 ns	< 25 ns
200 kA	200 kA	200 kA	200 kA
≤ 100 A	≤ 100 A	≤ 100 A	≤ 100 A
≤ 125 A	≤ 125 A	≤ 125 A	≤ 125 A
Yes	Yes	Yes	Yes
Yes	Yes	Yes	Yes
Yes	Yes	Yes	Yes
-	-	-	-
Yes	Yes	Yes	Yes
2.5...25 / 4...14 mm ²	2.5...25 / 4...14 mm ²	2.5...25 / 4...14 mm ²	2.5...25 / 4...14 mm ²
2.5...16 / 6...14 mm ²	2.5...16 / 6...14 mm ²	2.5...16 / 6...14 mm ²	2.5...16 / 6...14 mm ²
12.5 / 0.5 mm	12.5 / 0.5 mm	12.5 / 0.5 mm	12.5 / 0.5 mm
2.8 / 24.5 Nm	2.8 / 24.5 Nm	2.8 / 24.5 Nm	2.8 / 24.5 Nm
2 NO – 2 NC	2 NO – 2 NC	2 NO – 2 NC	2 NO – 2 NC
12 V DC – 10 mA	12 V DC – 10 mA	12 V DC – 10 mA	12 V DC – 10 mA
250 V AC – 1 A	250 V AC – 1 A	250 V AC – 1 A	250 V AC – 1 A
1.5 / 16 mm ²	1.5 / 16 mm ²	1.5 / 16 mm ²	1.5 / 16 mm ²
-40...+80 °C	-40...+80 °C	-40...+80 °C	-40...+80 °C
-40...+176 °C	-40...+176 °C	-40...+176 °C	-40...+176 °C
NEMA 1	NEMA 1	NEMA 1	NEMA 1
V0	V0	V0	V0
-	-	-	-
-	-	-	-
98.5 x 35.6 x 64.8 mm	98.5 x 35.6 x 64.8 mm	98.5 x 35.6 x 64.8 mm	98.5 x 35.6 x 64.8 mm
3.88 x 1.4 x 2.55 in	3.88 x 1.4 x 2.55 in	3.88 x 1.4 x 2.55 in	3.88 x 1.4 x 2.55 in
OVR T2 40-320 C U	OVR T2 40-440 C U	OVR T2 40-550 C U	OVR T2 40-660 C U
2CTB802348R3700	2CTB802348R3900	2CTB802348R4100	2CTB802348R4300
OVR T2 70 N C U	OVR T2 70 N C U	OVR T2 70 N C U	OVR T2 70 N C U
2CTB802348R6500	2CTB802348R6500	2CTB802348R6500	2CTB802348R6500

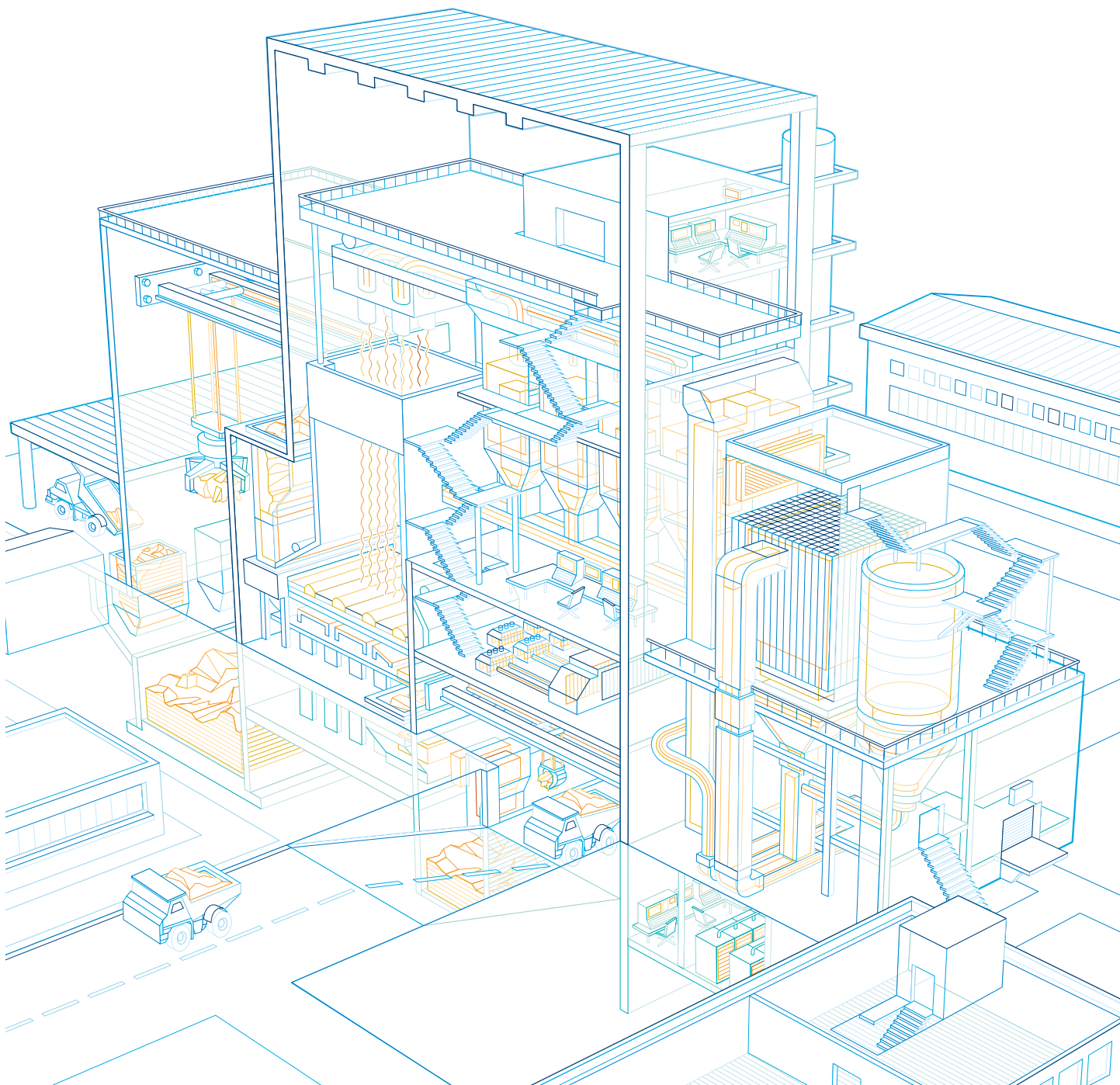

OVR Type 2 surge protective devices

Split phase networks



OVR T2 2L 15-320 P U



OVR T2 2L 40-320 P TS U



OVR T2 2N 15-320 P U



OVR T2 2N 40-440 P TS U

Type	Width mm
OVR T2 2L 15-150 P U	35.6
OVR T2 2L 15-320 P U	35.6
OVR T2 2L 40-150 P TS U	35.6
OVR T2 2L 40-320 P TS U	35.6
OVR T2 2N 15-150 P U	53.4
OVR T2 2N 15-320 P U	53.4
OVR T2 2N 40-150 P TS U	53.4
OVR T2 2N 40-320 P TS U	53.4
OVR T2 2N 40-440 P TS U	53.4
OVR T2 2N 40-550 P TS U	53.4
OVR T2 2N 40-660 P TS U	53.4

Description

Split phase devices are composed by two MOV poles or two MOV poles plus a spark gap one, depending on the number of lines the customer wants to protect. The spark gap pole guarantees the lowest voltage protection rating and has to be connected to the neutral.

OVR T2 devices provide the best protection as they are designed to protect electric installations and sensitive equipment against indirect surges with ensuring a low protection level (VPR). They are characterized by their capacity to safely discharge current with 8/20 μ s wave form.

Ordering details

Protected lines	Max discharge current I _{max} 8/20 kA	Nominal discharge current I _n kA	Voltage protection rating VPR kV	Nominal voltage U _n V	Max. cont. operating voltage MCOV, U _c V	Bbn 3660308 EAN	Type	Order code	Weight Pkg (1 pce) Kg
-----------------	--	---	----------------------------------	----------------------------------	---	-----------------	------	------------	-----------------------

Pluggable

2	15	5	0.6	120 ±15%	175	518590	OVR T2 2L 15-150 P U	2CTB802343R0000	0.24
2	15	5	1	277 ±15%	320	518606	OVR T2 2L 15-320 P U	2CTB802343R0400	0.24
2	40	20	0.6	120 ±15%	175	518613	OVR T2 2L 40-150 P TS U	2CTB802343R2100	0.24
2	40	20	1	277 ±15%	320	518620	OVR T2 2L 40-320 P TS U	2CTB802343R2500	0.24
3	15	5	0.7	120 ±15%	175	519306	OVR T2 2N 15-150 P U	2CTB802344R0000	0.36
3	15	5	1.1	277 ±15%	320	519313	OVR T2 2N 15-320 P U	2CTB802344R0400	0.36
3	40	20	0.7	120 ±15%	175	519320	OVR T2 2N 40-150 P TS U	2CTB802344R2100	0.36
3	40	20	1.1	277 ±15%	320	519337	OVR T2 2N 40-320 P TS U	2CTB802344R2500	0.36
3	40	10	1.4	347 ±15%	440	519344	OVR T2 2N 40-440 P TS U	2CTB802344R2900	0.36
3	40	10	1.8	480 ±15%	550	519351	OVR T2 2N 40-550 P TS U	2CTB802344R3300	0.36
3	40	10	2	600 ±15%	660	519368	OVR T2 2N 40-660 P TS U	2CTB802344R3700	0.36

Main dimensions mm

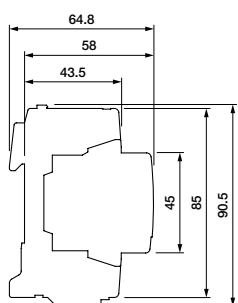

OVR T2 2L 15-150 P U
OVR T2 2L 15-320 P U
OVR T2 2N 15-150 P U
OVR T2 2N 15-320 P U

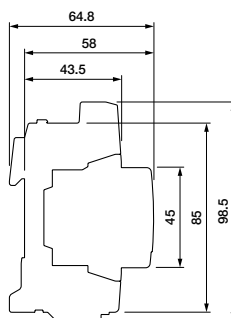

OVR T2 2L 40-150 P TS U
OVR T2 2L 40-320 P TS U
OVR T2 2N 40-150 P TS U
OVR T2 2N 40-320 P TS U
OVR T2 2N 40-440 P TS U
OVR T2 2N 40-550 P TS U
OVR T2 2N 40-660 P TS U

OVR Type 2 surge protective devices

Split phase networks

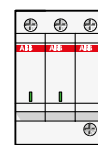

General technical data

Type	OVR T2 2L 15-150 P U	OVR T2 2L 15-320 P U	-	-	OVR T2 2N 15-150 P U
with auxiliary contact (TS)	-	-	OVR T2 2L 40-150 P TS U	OVR T2 2L 40-320 P TS U	-
Electrical features					
Standards	UL 1449	UL 1450	UL 1451	UL 1452	UL 1453
Type / test class (UL 1449)	1	1	1	1	4
Protected lines	2	2	2	2	3
Type of current / frequency	AC 47-63 Hz	AC 47-63 Hz	AC 47-63 Hz	AC 47-63 Hz	AC 47-63 Hz
Voltage regulation of the system network	±15%	±15%	±15%	±15%	±15%
Nominal system voltage Un	120 V ±15%	277 V ±15%	120 V ±15%	277 V ±15%	120 V ±15%
Maximum continuous operating voltage MCOV	175 V	320 V	175 V	320 V	175 V
Maximal discharge current (8/20) Imax	15 kA	15 kA	40 kA	40 kA	15 kA
Nominal discharge current (8/20) In	5 kA	5 kA	20 kA	20 kA	5 kA
Voltage protection rating (L-N / N-G / L-G) VPR	0.6 kV	1 kV	0.6 kV	1 kV	0.7 kV
Response time	< 25 ns	< 25 ns	< 25 ns	< 25 ns	< 25 ns
Short circuit withstand SCCR	200 kA	200 kA	200 kA	200 kA	200 kA
Back up protection fuse (gG - gL)	≤ 100 A	≤ 100 A	≤ 100 A	≤ 100 A	≤ 100 A
maximum rating circuit breaker (B or C curve)	≤ 125 A	≤ 125 A	≤ 125 A	≤ 125 A	≤ 125 A
Pluggable cartridges	Yes	Yes	Yes	Yes	Yes
Integrated QuickSafe® technology	Yes	Yes	Yes	Yes	Yes
State indicator	Yes	Yes	Yes	Yes	Yes
Safety reserve	-	-	-	-	-
Auxiliary contact (TS)	No	No	Yes	Yes	No
Installation					
Wire range (L,N,PE) solid wire	2.5...25 / 4...14 mm ²	2.5...25 / 4...14 mm ²	2.5...25 / 4...14 mm ²	2.5...25 / 4...14 mm ²	2.5...25 / 4...14 mm ²
stranded wire	2.5...16 / 6...14 mm ²	2.5...16 / 6...14 mm ²	2.5...16 / 6...14 mm ²	2.5...16 / 6...14 mm ²	2.5...16 / 6...14 mm ²
Stripping length (L,N,PE)	12.5 / 0.5	12.5 / 0.5	12.5 / 0.5	12.5 / 0.5	12.5 / 0.5
Tightening torque (L,N,PE)	2.8 / 24.5 Nm	2.8 / 24.5 Nm	2.8 / 24.5 Nm	2.8 / 24.5 Nm	2.8 / 24.5 Nm
Auxiliary contact (TS)					
Contact information	-	-	2 NO - 2 NC	2 NO - 2 NC	-
Min. load	-	-	12 V DC - 10 mA	12 V DC - 10 mA	-
Max. load	-	-	250 V AC - 1 A	250 V AC - 1 A	-
Connection cross section	-	-	1.5 / 16 mm ²	1.5 / 16 mm ²	-
Miscellaneous characteristics					
Stocking temperature	-40...+80 °C	-40...+80 °C	-40...+80 °C	-40...+80 °C	-40...+80 °C
Operating temperature	-40...+176 °C	-40...+176 °C	-40...+176 °C	-40...+176 °C	-40...+176 °C
Degree of protection	NEMA 1	NEMA 1	NEMA 1	NEMA 1	NEMA 1
Fire resistance according to UL 94	V0	V0	V0	V0	V0
Dimensions mm h x w x d	90.5 x 35.6 x 64.8 mm	90.5 x 35.6 x 64.8 mm	-	-	90.5 x 53.4 x 64.8 mm
inches h x w x d	3.56 x 1.4 x 2.55 in	3.56 x 1.4 x 2.55 in	-	-	3.56 x 2.1 x 2.55 in
Dimensions with auxiliary contact (TS) mm h x w x d	-	-	98.5 x 35.6 x 64.8 mm	98.5 x 35.6 x 64.8 mm	-
inches h x w x d	-	-	3.88 x 1.4 x 2.55 in	3.88 x 1.4 x 2.55 in	-
Replacement cartridges					
Phase product ID Type	OVR T2 15-150 C U	OVR T2 15-320 C U	OVR T2 40-150 C U	OVR T2 40-320 C U	OVR T2 15-150 C U
Order code	2CTB802348R2500	2CTB802348R2700	2CTB802348R3500	2CTB802348R3700	2CTB802348R2500
Neutral product ID Type	-	-	-	-	OVR T2 70 N C U
Order code	-	-	-	-	2CTB802348R6500

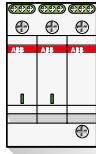
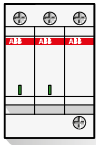

OVR T2 2N 15-320 P U	-	-	-	-	-
-	OVR T2 2N 40-150 P TS U	OVR T2 2N 40-320 P TS U	OVR T2 2N 40-440 P TS U	OVR T2 2N 40-550 P TS U	OVR T2 2N 40-660 P TS U
UL 1454	UL 1455	UL 1456	UL 1457	UL 1458	UL 1459
4	4	4	4	4	4
3	3	3	3	3	3
AC 47-63 Hz ±15%	AC 47-63 Hz ±15%	AC 47-63 Hz ±15%	AC 47-63 Hz ±15%	AC 47-63 Hz ±15%	AC 47-63 Hz ±15%
277 V ±15%	120 V ±15%	277 V ±15%	347 V ±15%	480 V ±15%	600 V ±15%
320 V	175 V	320 V	440 V	550 V	660 V
15 kA	40 kA	40 kA	40 kA	40 kA	40 kA
5 kA	20 kA	20 kA	10 kA	10 kA	10 kA
1.1 kV	0.7 kV	1.1 kV	1.4 kV	1.8 kV	2 kV
< 25 ns	< 25 ns	< 25 ns	< 25 ns	< 25 ns	< 25 ns
200 kA	200 kA	200 kA	200 kA	200 kA	200 kA
≤ 100 A	≤ 100 A	≤ 100 A	≤ 100 A	≤ 100 A	≤ 100 A
≤ 125 A	≤ 125 A	≤ 125 A	≤ 125 A	≤ 125 A	≤ 125 A
Yes	Yes	Yes	Yes	Yes	Yes
Yes	Yes	Yes	Yes	Yes	Yes
Yes	Yes	Yes	Yes	Yes	Yes
-	-	-	-	-	-
No	Yes	Yes	Yes	Yes	Yes
2.5...25 / 4...14 mm ²	2.5...25 / 4...14 mm ²	2.5...25 / 4...14 mm ²	2.5...25 / 4...14 mm ²	2.5...25 / 4...14 mm ²	2.5...25 / 4...14 mm ²
2.5...16 / 6...14 mm ²	2.5...16 / 6...14 mm ²	2.5...16 / 6...14 mm ²	2.5...16 / 6...14 mm ²	2.5...16 / 6...14 mm ²	2.5...16 / 6...14 mm ²
12.5 / 0.5	12.5 / 0.5	12.5 / 0.5	12.5 / 0.5	12.5 / 0.5	12.5 / 0.5
2.8 / 24.5 Nm	2.8 / 24.5 Nm	2.8 / 24.5 Nm	2.8 / 24.5 Nm	2.8 / 24.5 Nm	2.8 / 24.5 Nm
-	3 NO – 3 NC	3 NO – 3 NC	3 NO – 3 NC	3 NO – 3 NC	3 NO – 3 NC
-	12 V DC – 10 mA	12 V DC – 10 mA	12 V DC – 10 mA	12 V DC – 10 mA	12 V DC – 10 mA
-	250 V AC – 1 A	250 V AC – 1 A	250 V AC – 1 A	250 V AC – 1 A	250 V AC – 1 A
-	1.5 / 16 mm ²	1.5 / 16 mm ²	1.5 / 16 mm ²	1.5 / 16 mm ²	1.5 / 16 mm ²
-40...+80 °C	-40...+80 °C	-40...+80 °C	-40...+80 °C	-40...+80 °C	-40...+80 °C
-40...+176 °C	-40...+176 °C	-40...+176 °C	-40...+176 °C	-40...+176 °C	-40...+176 °C
NEMA 1	NEMA 1	NEMA 1	NEMA 1	NEMA 1	NEMA 1
V0	V0	V0	V0	V0	V0
90.5 x 53.4 x 64.8 mm	-	-	-	-	-
3.56 x 2.1 x 2.55 in	-	-	-	-	-
-	98.5 x 53.4 x 64.8 mm	98.5 x 53.4 x 64.8 mm	98.5 x 53.4 x 64.8 mm	98.5 x 53.4 x 64.8 mm	98.5 x 53.4 x 64.8 mm
-	3.88 x 2.1 x 2.55 in	3.88 x 2.1 x 2.55 in	3.88 x 2.1 x 2.55 in	3.88 x 2.1 x 2.55 in	3.88 x 2.1 x 2.55 in
-	1 NO – 1 NC	1 NO – 1 NC	1 NO – 1 NC	1 NO – 1 NC	1 NO – 1 NC
OVR T2 15-320 C U	OVR T2 40-150 C U	OVR T2 40-320 C U	OVR T2 40-440 C U	OVR T2 40-550 C U	OVR T2 40-660 C U
2CTB802348R2700	2CTB802348R3500	2CTB802348R3700	2CTB802348R3900	2CTB802348R4100	2CTB802348R4300
OVR T2 70 N C U	OVR T2 70 N C U	OVR T2 70 N C U	OVR T2 70 N C U	OVR T2 70 N C U	OVR T2 70 N C U
2CTB802348R6500	2CTB802348R6500	2CTB802348R6500	2CTB802348R6500	2CTB802348R6500	2CTB802348R6500

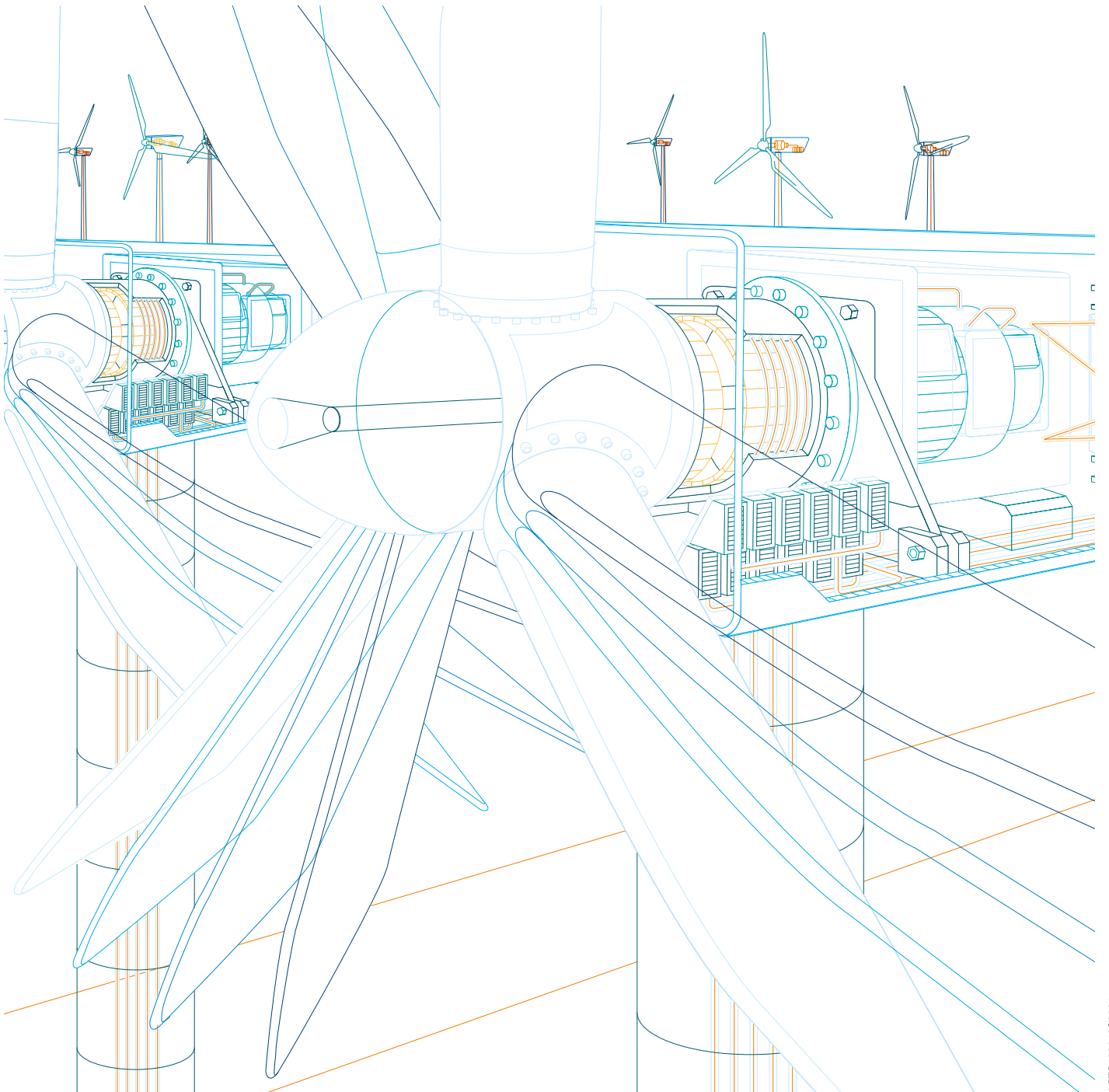

2CTC432019S0201

OVR Type 2 surge protective devices

Grounded Wye networks



OVR T2 3L 40-440 P TS U

Description

Wye devices are composed by three MOV poles or three MOV poles plus a spark gap one, depending on the number of lines the customer wants to protect. The spark gap pole guarantees the lowest voltage protection rating and has to be connected to the Neutral.

OVR T2 devices provide the best protection as they are designed to protect electric installations and sensitive equipment against indirect surges with ensuring a low protection level (VPR). They are characterized by their capacity to safely discharge current with 8/20 μ s wave form.

Ordering details

Pro- tected lines	Max dis- charge current I_{max} 8/20 kA	Nominal dis- charge current I_n kA	Voltage protec- tion rating VPR kV	Nominal voltage U_n V	Max. cont. operating voltage MCOV, U_c V	Bbn 3660308 EAN	Type	Order code	Weight Pkg (1 pce) kg
-------------------------	---	---	---	----------------------------------	--	-----------------------	------	------------	--------------------------------

Pluggable

3	15	5	0.6	120 \pm 15%	175	518637	OVR T2 3L 15-150 P U	2CTB802345R0000	0.36
3	40	20	0.6	120 \pm 15%	175	518651	OVR T2 3L 40-150 P TS U	2CTB802345R2100	0.36
3	40	10	1.3	347 \pm 15%	440	518675	OVR T2 3L 40-440 P TS U	2CTB802345R2900	0.36
4	15	5	1.2	120 \pm 15%	175	518699	OVR T2 3N 15-150 P U	2CTB802346R0000	0.48
4	15	5	1.2	277 \pm 15%	320	518705	OVR T2 3N 15-320 P U	2CTB802346R0400	0.48
4	40	20	1.2	120 \pm 15%	175	518712	OVR T2 3N 40-150 P TS U	2CTB802346R2100	0.48
4	40	20	1.2	277 \pm 15%	320	518729	OVR T2 3N 40-320 P TS U	2CTB802346R2500	0.48
4	40	10	1.2	347 \pm 15%	440	518736	OVR T2 3N 40-440 P TS U	2CTB802346R2900	0.48
4	40	10	1.2	480 \pm 15%	550	518743	OVR T2 3N 40-550 P TS U	2CTB802346R3300	0.48
4	40	10	1.2	600 \pm 15%	660	518750	OVR T2 3N 40-660 P TS U	2CTB802346R3700	0.48

Main dimensions mm

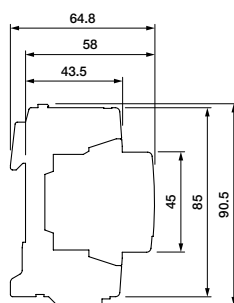

OVR T2 3L 15-150 P U
OVR T2 3N 15-150 P U
OVR T2 3N 15-320 P U

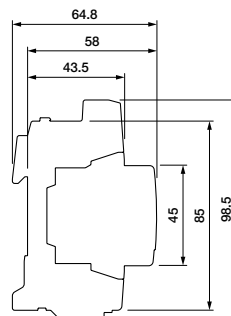

OVR T2 3L 40-150 P TS U
OVR T2 3L 40-440 P TS U
OVR T2 3N 40-150 P TS U
OVR T2 3N 40-320 P TS U
OVR T2 3N 40-440 P TS U
OVR T2 3N 40-550 P TS U
OVR T2 3N 40-660 P TS U

Type	Width mm
OVR T2 3L 15-150 P U	53.4
OVR T2 3L 40-150 P TS U	53.4
OVR T2 3L 40-440 P TS U	53.4
OVR T2 3N 15-150 P U	71.2
OVR T2 3N 15-320 P U	71.2
OVR T2 3N 40-150 P TS U	71.2
OVR T2 3N 40-320 P TS U	71.2
OVR T2 3N 40-440 P TS U	71.2
OVR T2 3N 40-550 P TS U	71.2
OVR T2 3N 40-660 P TS U	71.2

OVR Type 2 surge protective devices

Grounded Wye networks

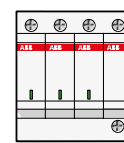

General technical data

Type	OVR T2 3L 15-150 P U	-	-	OVR T2 3N 15-150 P U
with auxiliary contact (TS)	-	OVR T2 3L 40-150 P TS U	OVR T2 3L 40-440 P TS U	-
Electrical features				
Standards	UL 1449	UL 1449	UL 1449	UL 1449
Type / test class (UL 1449)	1	1	1	4
Protected lines	3	3	3	4
Type of current / frequency	AC 47-63 Hz	AC 47-63 Hz	AC 47-63 Hz	AC 47-63 Hz
Voltage regulation of the system network	±15%	±15%	±15%	±15%
Nominal system voltage Un	120 V ±15%	120 V ±15%	347 V ±15%	120 V ±15%
Maximum continuous operating voltage MCOV	175 V	175 V	440 V	175 V
Maximal discharge current (8/20) I _{max}	15 kA	40 kA	40 kA	15 kA
Nominal discharge current (8/20) I _n	5 kA	10 kA	10 kA	5 kA
Voltage protection rating (L-N / N-G / L-G VPR)	0.6 kV	0.6 kV	1.3 kV	0.6 kV
Response time	< 25 ns	< 25 ns	< 25 ns	< 25 ns
Short circuit withstand SCCR	200 kA	200 kA	200 kA	200 kA
Back up protection fuse (gG - gL)	≤ 100 A	≤ 100 A	≤ 100 A	≤ 100 A
maximum rating circuit breaker (B or C curve)	≤ 125 A	≤ 125 A	≤ 125 A	≤ 125 A
Pluggable cartridges	Yes	Yes	Yes	Yes
Integrated QuickSafe® technology	Yes	Yes	Yes	Yes
State indicator	Yes	Yes	Yes	Yes
Safety reserve	-	-	-	-
Auxiliary contact (TS)	No	Yes	Yes	No
Installation				
Wire range (L,N,PE) solid wire	2.5...25 / 4...14 mm ²	2.5...25 / 4...14 mm ²	2.5...25 / 4...14 mm ²	2.5...25 / 4...14 mm ²
stranded wire	2.5...16 / 6...14 mm ²	2.5...16 / 6...14 mm ²	2.5...16 / 6...14 mm ²	2.5...16 / 6...14 mm ²
Stripping length (L,N,PE)	12.5 / 0.5 mm	12.5 / 0.5 mm	12.5 / 0.5 mm	12.5 / 0.5 mm
Tightening torque (L,N,PE)	2.8 / 24.5 Nm	2.8 / 24.5 Nm	2.8 / 24.5 Nm	2.8 / 24.5 Nm
Auxiliary contact (TS)				
Contact information	-	4 NO - 4 NC	4 NO - 4 NC	-
Min. load	-	12 V DC - 10 mA	12 V DC - 10 mA	-
Max. load	-	250 V AC - 1 A	250 V AC - 1 A	-
Connection cross section	-	1.5 / 16 mm ²	1.5 / 16 mm ²	-
Miscellaneous characteristics				
Stocking temperature	-40...+80 °C	-40...+80 °C	-40...+80 °C	-40...+80 °C
Operating temperature	-40...+176 °C	-40...+176 °C	-40...+176 °C	-40...+176 °C
Degree of protection	NEMA 1	NEMA 1	NEMA 1	NEMA 1
Fire resistance according to UL 94	V0	V0	V0	V0
Dimensions	mm h x w x d 90.5 x 53.4 x 64.8 mm	-	-	90.5 x 71.2 x 64.8 mm
	inches h x w x d 3.56 x 2.1 x 2.55 in	-	-	3.56 x 2.8 x 2.55 in
Dimensions with auxiliary contact (TS)	mm h x w x d -	98.5 x 53.4 x 64.8 mm	98.5 x 53.4 x 64.8 mm	-
	inches h x w x d -	3.88 x 2.1 x 2.55 in	3.88 x 2.1 x 2.55 in	-
Replacement cartridges				
Phase product ID	Type OVR T2 15-150 C U	Type OVR T2 40-150 C U	Type OVR T2 40-440 C U	Type OVR T2 15-150 C U
Order code	2CTB802348R2500	2CTB802348R3500	2CTB802348R3900	2CTB802348R2500
Neutral product ID	Type -	Type -	Type -	Type OVR T2 70 N C U
Order code	-	-	-	2CTB802348R6500

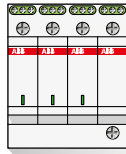
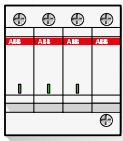

OVR T2 3N 15-320 P U	-	-	-	-	-
-	OVR T2 3N 40-150 P TS U	OVR T2 3N 40-320 P TS U	OVR T2 3N 40-440 P TS U	OVR T2 3N 40-550 P TS U	OVR T2 3N 40-660 P TS U
UL 1449	UL 1449	UL 1449	UL 1449	UL 1449	UL 1449
4	4	4	4	4	4
4	4	4	4	4	4
AC 47-63 Hz ±15%	AC 47-63 Hz ±15%	AC 47-63 Hz ±15%	AC 47-63 Hz ±15%	AC 47-63 Hz ±15%	AC 47-63 Hz ±15%
277 V ±15%	120 V ±15%	277 V ±15%	347 V ±15%	480 V ±15%	600 V ±15%
320 V	175 V	320 V	440 V	550 V	660 V
15 kA	40 kA	40 kA	40 kA	40 kA	40 kA
5 kA	20 kA	20 kA	10 kA	10 kA	10 kA
1 kV	1.2 kV	1.2 kV	1.2 kV	1.2 kV	1.2 kV
< 25 ns	< 25 ns	< 25 ns	< 25 ns	< 25 ns	< 25 ns
200 kA	200 kA	200 kA	200 kA	200 kA	200 kA
≤ 100 A	≤ 100 A	≤ 100 A	≤ 100 A	≤ 100 A	≤ 100 A
≤ 125 A	≤ 125 A	≤ 125 A	≤ 125 A	≤ 125 A	≤ 125 A
Yes	Yes	Yes	Yes	Yes	Yes
Yes	Yes	Yes	Yes	Yes	Yes
Yes	Yes	Yes	Yes	Yes	Yes
-	-	-	-	-	-
No	Yes	Yes	Yes	Yes	Yes
2.5...25 / 4...14 mm ²	2.5...25 / 4...14 mm ²	2.5...25 / 4...14 mm ²	2.5...25 / 4...14 mm ²	2.5...25 / 4...14 mm ²	2.5...25 / 4...14 mm ²
2.5...16 / 6...14 mm ²	2.5...16 / 6...14 mm ²	2.5...16 / 6...14 mm ²	2.5...16 / 6...14 mm ²	2.5...16 / 6...14 mm ²	2.5...16 / 6...14 mm ²
12.5 / 0.5 mm	12.5 / 0.5 mm	12.5 / 0.5 mm	12.5 / 0.5 mm	12.5 / 0.5 mm	12.5 / 0.5 mm
2.8 / 24.5 Nm	2.8 / 24.5 Nm	2.8 / 24.5 Nm	2.8 / 24.5 Nm	2.8 / 24.5 Nm	2.8 / 24.5 Nm
-	4 NO – 4 NC	4 NO – 4 NC	4 NO – 4 NC	4 NO – 4 NC	4 NO – 4 NC
-	12 V DC – 10 mA	12 V DC – 10 mA	12 V DC – 10 mA	12 V DC – 10 mA	12 V DC – 10 mA
-	250 V AC – 1 A	250 V AC – 1 A	250 V AC – 1 A	250 V AC – 1 A	250 V AC – 1 A
-	1.5 / 16 mm ²	1.5 / 16 mm ²	1.5 / 16 mm ²	1.5 / 16 mm ²	1.5 / 16 mm ²
-40...+80 °C	-40...+80 °C	-40...+80 °C	-40...+80 °C	-40...+80 °C	-40...+80 °C
-40...+176 °C	-40...+176 °C	-40...+176 °C	-40...+176 °C	-40...+176 °C	-40...+176 °C
NEMA 1	NEMA 1	NEMA 1	NEMA 1	NEMA 1	NEMA 1
V0	V0	V0	V0	V0	V0
90.5 x 71.2 x 64.8 mm	-	-	-	-	-
3.56 x 2.8 x 2.55 in	-	-	-	-	-
-	98.5 x 71.2 x 64.8 mm	98.5 x 71.2 x 64.8 mm	98.5 x 71.2 x 64.8 mm	98.5 x 71.2 x 64.8 mm	98.5 x 71.2 x 64.8 mm
-	3.88 x 2.8 x 2.55 in	3.88 x 2.8 x 2.55 in	3.88 x 2.8 x 2.55 in	3.88 x 2.8 x 2.55 in	3.88 x 2.8 x 2.55 in
OVR T2 15-320 C U	OVR T2 40-150 C U	OVR T2 40-320 C U	OVR T2 40-440 C U	OVR T2 40-550 C U	OVR T2 40-660 C U
2CTB802348R2700	2CTB802348R3500	2CTB802348R3700	2CTB802348R3900	2CTB802348R4100	2CTB802348R4300
OVR T2 70 N C U	OVR T2 70 N C U	OVR T2 70 N C U	OVR T2 70 N C U	OVR T2 70 N C U	OVR T2 70 N C U
2CTB802348R6500	2CTB802348R6500	2CTB802348R6500	2CTB802348R6500	2CTB802348R6500	2CTB802348R6500

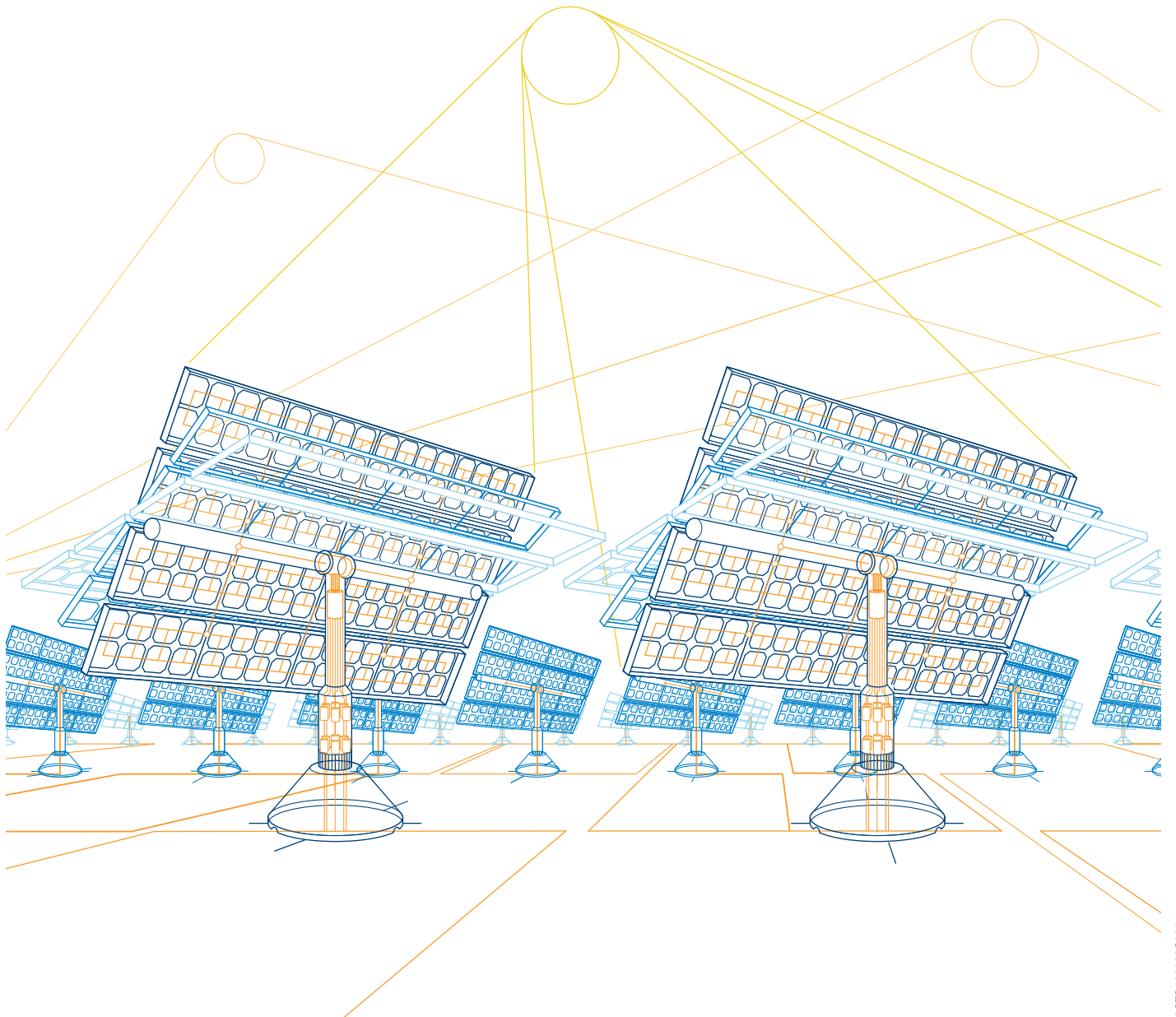

OVR PV surge protection devices

Photovoltaic applications



OVR PV 40-1000 P TS U

Description

Specifically designed for photovoltaic DC installations, the OVR PV family provide a safe and reliable surge and lightning protection of solar panels and converters.

The OVR PV surge protective devices comply with UL 1449.

Ordering details

Protected lines	Max discharge current I _{max} 8/20 kA	Nominal discharge current I _n kA	Voltage protection rating VPR kV	Nominal voltage U _n V	Max. cont. operating voltage MCOV, U _c V	Bbn 3660308 EAN	Type	Order code	Weight Pkg (1 pce) kg
-----------------	--	---	----------------------------------	----------------------------------	---	-----------------	------	------------	-----------------------

Pluggable

2	15	5	3	600	670	521088	OVR PV 15-600 P U	2CTB802340R5600	0.36
2	15	5	3	600	670	521095	OVR PV 15-600 P TS U	2CTB802340R5700	0.36
2	40	10	3	600	670	521101	OVR PV 40-600 P U	2CTB802340R0800	0.36
2	40	10	3	600	670	521118	OVR PV 40-600 P TS U	2CTB802340R0900	0.36
2	15	5	4	800	1000	521125	OVR PV 15-800 P U	2CTB802340R6800	0.36
2	15	5	4	800	1000	521132	OVR PV 15-800 P TS U	2CTB802340R6900	0.36
2	40	10	4	800	1000	521149	OVR PV 40-800 P U	2CTB802340R2000	0.36
2	40	10	4	800	1000	521156	OVR PV 40-800 P TS U	2CTB802340R2100	0.36
2	15	5	4	1000	1250	521163	OVR PV 15-1000 P U	2CTB802340R8000	0.36
2	15	5	4	1000	1250	521170	OVR PV 15-1000 P TS U	2CTB802340R8100	0.36
2	40	10	4	1000	1250	521187	OVR PV 40-1000 P U	2CTB802340R3200	0.36
2	40	10	4	1000	1250	521194	OVR PV 40-1000 P TS U	2CTB802340R3300	0.36
2	40	15	4.5	1500	1500	524829	OVR PV 40-1500H P U	2CTB802340R4200	0.36
2	40	15	4.5	1500	1500	524812	OVR PV 40-1500H P TS U	2CTB802340R4300	0.36

Type	Width mm
OVR PV 15-600 P U	53.4
OVR PV 15-600 P TS U	53.4
OVR PV 40-600 P U	53.4
OVR PV 40-600 P TS U	53.4
OVR PV 15-800 P U	53.4
OVR PV 15-800 P TS U	53.4
OVR PV 40-800 P U	53.4
OVR PV 40-800 P TS U	53.4
OVR PV 15-1000 P U	53.4
OVR PV 15-1000 P TS U	53.4
OVR PV 40-1000 P U	53.4
OVR PV 40-1000 P TS U	53.4
OVR PV 40-1500H P U	53.4
OVR PV 40-1500H P TS U	53.4

Main dimensions mm

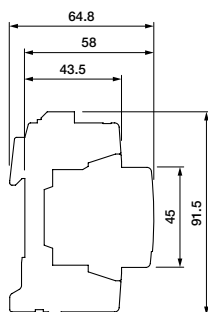

OVR PV 15-600 P U
 OVR PV 40-600 P U
 OVR PV 15-800 P U
 OVR PV 40-800 P U
 OVR PV 15-1000 P U
 OVR PV 40-1000 P U
 OVR PV 40-1500H P U

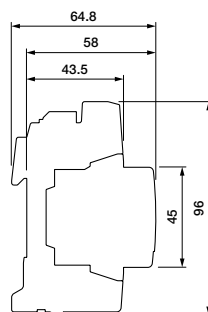

OVR PV 15-600 P TS U
 OVR PV 40-600 P TS U
 OVR PV 15-800 P TS U
 OVR PV 40-800 P TS U
 OVR PV 15-1000 P TS U
 OVR PV 40-1000 P TS U
 OVR PV 40-1500H P TS U

OVR PV surge protection devices

Photovoltaic applications

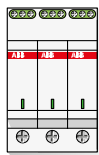

General technical data

Type	OVR PV 15-600 P U	OVR PV 40-600 P U	OVR PV 15-800 P U
with auxiliary contact (TS)	OVR PV 15-600 P TS U	OVR PV 40-600 P TS U	OVR PV 15-800 P TS U
Technology	Varistor	Varistor	Varistor
Electrical features			
Standards	UL 1449	UL 1449	UL 1449
Type / test class (UL 1449)	1	1	1
Protected lines	2	2	2
Type of current / frequency	Photovoltaic systems - DC side	Photovoltaic systems - DC side	Photovoltaic systems - DC side
Voltage regulation of the system network	DC	DC	DC
Nominal system voltage Un	600 V	600 V	800 V
Maximum continuous operating voltage MCOV	670 V	670 V	1000 V
Maximal discharge current (8/20) Imax	15 kA	40 kA	15 kA
Nominal discharge current (8/20) In	5 kA	10 kA	5 kA
Voltage protection rating (L-N / N-G / L-G) VPR	3 kV	3 kV	4 kV
Response time	< 25 ns	< 25 ns	< 25 ns
Residual Current IPE	< 25 µA	< 25 µA	< 25 µA
Short circuit withstand SCCR	1 kA	1 kA	1 kA
Disconnecter fuse (gG - gL)	-	-	-
circuit breaker (B or C curve)	-	-	-
Pluggable cartridges	Yes	Yes	Yes
Integrated QuickSafe® technology	Yes	Yes	Yes
State indicator	Yes	Yes	Yes
Safety reserve	No	No	No
Auxiliary contact (TS)	Yes (TS option)	Yes (TS option)	Yes (TS option)
Installation			
Wire range (L,N,PE) solid wire	2.5...25 / 4...14 mm ²	2.5...25 / 4...14 mm ²	2.5...25 / 4...14 mm ²
stranded wire	2.5...16 / 6...14 mm ²	2.5...16 / 6...14 mm ²	2.5...16 / 6...14 mm ²
Stripping length (L,N,PE)	12.5 / 0.5 mm	12.5 / 0.5 mm	12.5 / 0.5 mm
Tightening torque (L,N,PE)	2.8 / 24.5 Nm	2.8 / 24.5 Nm	2.8 / 24.5 Nm
Auxiliary contact (TS)			
Contact information	3 NO – 3 NC	3 NO – 3 NC	3 NO – 3 NC
Min. load	12 V DC – 10 mA	12 V DC – 10 mA	12 V DC – 10 mA
Max. load	250 V AC – 1 A	250 V AC – 1 A	250 V AC – 1 A
Connection cross section	1.5...16 mm ²	1.5...16 mm ²	1.5...16 mm ²
Miscellaneous characteristics			
Stocking and operating temperature	-40...+80 °C	-40...+80 °C	-40...+80 °C
Degree of protection	NEMA 1	NEMA 1	NEMA 1
Fire resistance according to UL 94	V0	V0	V0
Dimensions	mm h x w x d 91.5 x 53.4 x 64.8 mm	91.5 x 53.4 x 64.8 mm	91.5 x 53.4 x 64.8 mm
	inches h x w x d 3.6 x 2.1 x 2.55 in	3.6 x 2.1 x 2.55 in	3.6 x 2.1 x 2.55 in
Dimensions with auxiliary contact (TS)	mm h x w x d 96 x 53.4 x 64.8 mm	96 x 53.4 x 64.8 mm	96 x 53.4 x 64.8 mm
	inches h x w x d 3.78 x 2.1 x 2.55 in	3.78 x 2.1 x 2.55 in	3.78 x 2.1 x 2.55 in
Replacement cartridges			
Phase product ID	Type	OVR PV 40-600 C U	OVR PV 15-800 C U
Order code		2CTB802349R2900	2CTB802349R3500

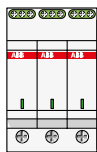

OVR PV 40-800 P U OVR PV 40-800 P TS U	OVR PV 15-1000 P U OVR PV 15-1000 P TS U	OVR PV 40-1000 P U OVR PV 40-1000 P TS U	OVR PV 40-1500H P U OVR PV 40-1500H P TS U
Varistor	Varistor	Varistor	Varistor
UL 1449	UL 1449	UL 1449	UL 1449
1	1	1	1
2	2	2	2
Photovoltaic systems - DC side	Photovoltaic systems - DC side	Photovoltaic systems - DC side	Photovoltaic systems - DC side
DC	DC	DC	DC
800 V	1000 V	1000 V	1500 V
1000 V	1250 V	1250 V	1500 V
40 kA	15 kA	40 kA	40 kA
10 kA	5 kA	10 kA	15 kA
4 kV	4 kV	4 kV	4.5 kV
< 25 ns	< 25 ns	< 25 ns	< 25 ns
< 25 µA	< 25 µA	< 25 µA	< 25 µA
1 kA	1 kA	1 kA	1 kA
-	-	-	-
-	-	-	-
Yes	Yes	Yes	Yes
Yes	Yes	Yes	Yes
Yes	Yes	Yes	Yes
No	No	No	No
Yes (TS option)	Yes (TS option)	Yes (TS option)	Yes (TS option)
2.5...25 / 4...14 mm ²	2.5...25 / 4...14 mm ²	2.5...25 / 4...14 mm ²	2.5...25 / 4...14 mm ²
2.5...16 / 6...14 mm ²	2.5...16 / 6...14 mm ²	2.5...16 / 6...14 mm ²	2.5...16 / 6...14 mm ²
12.5 / 0.5 mm	12.5 / 0.5 mm	12.5 / 0.5 mm	12.5 / 0.5 mm
2.8 / 24.5 Nm	2.8 / 24.5 Nm	2.8 / 24.5 Nm	2.8 / 24.5 Nm
3 NO - 3 NC	3 NO - 3 NC	3 NO - 3 NC	3 NO - 3 NC
12 V DC - 10 mA	12 V DC - 10 mA	12 V DC - 10 mA	12 V DC - 10 mA
250 V AC - 1 A	250 V AC - 1 A	250 V AC - 1 A	250 V AC - 1 A
1.5...16 mm ²	1.5...16 mm ²	1.5...16 mm ²	1.5...16 mm ²
-40...+80 °C	-40...+80 °C	-40...+80 °C	-40...+80 °C
NEMA 1	NEMA 1	NEMA 1	NEMA 1
V0	V0	V0	V0
91.5 x 53.4 x 64.8 mm	91.5 x 53.4 x 64.8 mm	91.5 x 53.4 x 64.8 mm	91.5 x 53.4 x 64.8 mm
3.6 x 2.1 x 2.55 in	3.6 x 2.1 x 2.55 in	3.6 x 2.1 x 2.55 in	3.6 x 2.1 x 2.55 in
96 x 53.4 x 64.8 mm	96 x 53.4 x 64.8 mm	96 x 53.4 x 64.8 mm	96 x 53.4 x 64.8 mm
3.78 x 2.1 x 2.55 in	3.78 x 2.1 x 2.55 in	3.78 x 2.1 x 2.55 in	3.78 x 2.1 x 2.55 in
OVR PV 40-800 C U	OVR PV 15-1000 C U	OVR PV 40-1000 C U	OVR PV 40-1500H C U
2CTB802349R1000	2CTB802349R4100	2CTB802349R1600	2CTB802349R1700

OVR TC surge protective devices

Dataline protection



OVR TC 200FR US

Description

The OVR TC family offers a reliable surge protection to dataline networks for datacenters, water treatment installations or wind turbine installations.

With the RJ11 and RJ45 bases they allow a flexible and easy installation.

Ordering details

Protected lines	Max discharge current I_{max} 8/20 kA	Nominal discharge current I_n kA	Voltage protection rating V_{PR} V	Nominal voltage U_n V	Max. cont. operating voltage MCOV, U_c V	Bbn 3660308 EAN	Type	Order code	Weight Pkg (1 pce) kg
-----------------	--	--	--	-------------------------------	---	---------------------------	------	------------	--

Pluggable

1	10	5	300	200	220	512291	OVR TC 200FR US	2CTB811814R0000	0.15
1	10	5	15	6	7	512246	OVR TC 06V US	2CTB811814R0100	0.15
1	10	5	20	12	14	512253	OVR TC 12V US	2CTB811814R0200	0.15
1	10	5	35	24	27	512260	OVR TC 24V US	2CTB811814R0300	0.15
1	10	5	70	48	53	512277	OVR TC 48V US	2CTB811814R0400	0.15

Main dimensions mm

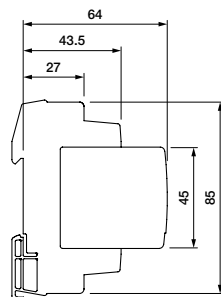

OVR TC 200FR US
OVR TC 06V US
OVR TC 12V US
OVR TC 24V US
OVR TC 48V US

Type	Width mm
OVR TC 200FR US	12
OVR TC 06V US	12
OVR TC 12V US	12
OVR TC 24V US	12
OVR TC 48V US	12

OVR TC surge protection devices

Dataline protection



General technical data

	OVR TC 200FR US	OVR TC 06V US	OVR TC 12V US	OVR TC 24V US	OVR TC 48V US
Type	–	–	–	–	–
with auxiliary contact (TS)	–	–	–	–	–
Connection configuration	Serie	Serie	Serie	Serie	Serie
Electrical features					
Standards	UL 1449	UL 1449	UL 1449	UL 1449	UL 1449
Test class	II	II	II	II	II
Number of protected wires	1	1	1	1	1
Types of network	RTC analog / ADSL	MIC/T2 - RS422/485	RS232	LS - 4/20mA	RNIS - To
Type of current	DC	DC	DC	DC	DC
Nominal voltage Un	200 V	6 V	12 V	24 V	48 V
Maximal continuous operating voltage M _{cov}	220 V	7 V	14 V	27 V	53 V
Maximal discharge current (8/20) I _{max}	10 kA	10 kA	10 kA	10 kA	10 kA
Nominal discharge current (8/20) I _n	5 kA	5 kA	5 kA	5 kA	5 kA
Voltage protection level at I _n / V _{PR}	300 V	15 V	20 V	35 V	70 V
Short circuit withstand current	10 kA	10 kA	10 kA	10 kA	10 kA
Response time	<1 ns	<1 ns	<1 ns	<1 ns	<1 ns
Operating current I _c (mA)	140 mA	140 mA	140 mA	140 mA	140 mA
Series resistance (Ohm)	10 Ohm	10 Ohm	10 Ohm	10 Ohm	10 Ohm
Cut frequency	3 MHz	10 MHz	2 MHz	4 MHz	6 MHz
Pluggable unit	No	No	No	No	No
State Indicator	Yes	Yes	Yes	Yes	Yes
Safety reserve	No	No	No	No	No
Auxiliary contact (TS)	No	No	No	No	No
Installation					
Wire range (L, N, PE) solid wire	0.5...2.5 mm ²	0.5...2.5 mm ²	0.5...2.5 mm ²	0.5...2.5 mm ²	0.5...2.5 mm ²
stranded wire	–	–	–	–	–
Stripping length (L, N, PE)	6 mm ²	6 mm ²	6 mm ²	6 mm ²	6 mm ²
Tightening torque (L, N, PE)	0.2 Nm	0.2 Nm	0.2 Nm	0.2 Nm	0.2 Nm
Auxiliary contact (TS)					
Contact complement	–	–	–	–	–
Min. load	–	–	–	–	–
Max. load	–	–	–	–	–
Connection cross section	–	–	–	–	–
Miscellaneous characteristics					
Operating temperature	-40...+80 °C	-40...+80 °C	-40...+80 °C	-40...+80 °C	-40...+80 °C
Degree of protection	IP20	IP20	IP20	IP20	IP20
Fire resistance according to UL 94	V0	V0	V0	V0	V0
Dimensions					
mm	h x w x d	85 x 12 x 64 mm	85 x 12 x 64 mm	85 x 12 x 64 mm	85 x 12 x 64 mm
inches	h x w x d	3.35 x 0.47 x 2.52 in	3.35 x 0.47 x 2.52 in	3.35 x 0.47 x 2.52 in	3.35 x 0.47 x 2.52 in

Index

Order code classification

Order code	Type	Page
2CTB8023540R0000	OVR WT 3L 690 P TS	98
2CTB802340R0800	OVR PV 40-600 P U	129
2CTB802340R0900	OVR PV 40-600 P TS U	129
2CTB802340R2000	OVR PV 40-800 P U	129
2CTB802340R2100	OVR PV 40-800 P TS U	129
2CTB802340R3200	OVR PV 40-1000 P U	129
2CTB802340R3300	OVR PV 40-1000 P TS U	129
2CTB802340R4200	OVR PV 40-1500H P U	129
2CTB802340R4300	OVR PV 40-1500H P TS U	129
2CTB802340R5600	OVR PV 15-600 P U	129
2CTB802340R5700	OVR PV 15-600 P TS U	129
2CTB802340R6800	OVR PV 15-800 P U	129
2CTB802340R6900	OVR PV 15-800 P TS U	129
2CTB802340R8000	OVR PV 15-1000 P U	129
2CTB802340R8100	OVR PV 15-1000 P TS U	129
2CTB802341R0000	OVR T2 15-150 P U	111
2CTB802341R0400	OVR T2 15-320 P U	111
2CTB802341R2000	OVR T2 40-150 P U	111
2CTB802341R2100	OVR T2 40-150 P TS U	111
2CTB802341R2400	OVR T2 40-320 P U	111
2CTB802341R2500	OVR T2 40-320 P TS U	111
2CTB802341R2900	OVR T2 40-440 P TS U	111
2CTB802341R3300	OVR T2 40-550 P TS U	111
2CTB802341R3700	OVR T2 40-660 P TS U	111
2CTB802341R8000	OVR T2 70 N P U	111
2CTB802342R0000	OVR T2 1N 15-150 P U	117
2CTB802342R0400	OVR T2 1N 15-320 P U	117
2CTB802342R2000	OVR T2 1N 40-150 P U	117
2CTB802342R2100	OVR T2 1N 40-150 P TS U	117
2CTB802342R2500	OVR T2 1N 40-320 P TS U	117
2CTB802342R2900	OVR T2 1N 40-440 P TS U	117
2CTB802342R3300	OVR T2 1N 40-550 P TS U	117
2CTB802342R3700	OVR T2 1N 40-660 P TS U	117
2CTB802342R8000	OVR T2 1N 40-150 P U (x10)	117
2CTB802343R0000	OVR T2 2L 15-150 P U	121
2CTB802343R0400	OVR T2 2L 15-320 P U	121
2CTB802343R2100	OVR T2 2L 40-150 P TS U	121
2CTB802343R2500	OVR T2 2L 40-320 P TS U	121
2CTB802344R0000	OVR T2 2N 15-150 P U	121
2CTB802344R0400	OVR T2 2N 15-320 P U	121
2CTB802344R2100	OVR T2 2N 40-150 P TS U	121
2CTB802344R2500	OVR T2 2N 40-320 P TS U	121
2CTB802344R2900	OVR T2 2N 40-440 P TS U	121
2CTB802344R3300	OVR T2 2N 40-550 P TS U	121
2CTB802344R3700	OVR T2 2N 40-660 P TS U	121
2CTB802345R0000	OVR T2 3L 15-150 P U	125
2CTB802345R0400	OVR T2 3L 15-320 P U	114
2CTB802345R2100	OVR T2 3L 40-150 P TS U	125
2CTB802345R2500	OVR T2 3L 40-320 P TS U	114
2CTB802345R2900	OVR T2 3L 40-440 P TS U	125
2CTB802345R3300	OVR T2 3L 40-550 P TS U	114
2CTB802346R0000	OVR T2 3N 15-150 P U	125
2CTB802346R0400	OVR T2 3N 15-320 P U	125
2CTB802346R2100	OVR T2 3N 40-150 P TS U	125
2CTB802346R2500	OVR T2 3N 40-320 P TS U	125
2CTB802346R2900	OVR T2 3N 40-440 P TS U	125
2CTB802346R3300	OVR T2 3N 40-550 P TS U	125
2CTB802346R3700	OVR T2 3N 40-660 P TS U	125
2CTB802348R2500	OVR T2 15-150 C U	109
2CTB802348R2700	OVR T2 15-320 C U	109
2CTB802348R3500	OVR T2 40-150 C U	109
2CTB802348R3700	OVR T2 40-320 C U	109
2CTB802348R3900	OVR T2 40-440 C U	109
2CTB802348R4100	OVR T2 40-550 C U	109
2CTB802348R4300	OVR T2 40-660 C U	109
2CTB802348R6500	OVR T2 70 N C U	108
2CTB802349R0400	OVR PV 40-600 C U	110
2CTB802349R1000	OVR PV 40-800 C U	110
2CTB802349R1600	OVR PV 40-1000 C U	110
2CTB802349R1700	OVR PV 40-1500H C U	110
2CTB802349R2900	OVR PV 15-600 C U	110
2CTB802349R3500	OVR PV 15-800 C U	110
2CTB802349R4100	OVR PV 15-1000 C U	110
2CTB803701R0100	OVR PLUS N1 40	92
2CTB803701R0300	OVR PLUS N3 40	92
2CTB803701R0400	OVR PLUS N3 20	92
2CTB803701R0700	OVR PLUS N1 20	92
2CTB803851R2700	OVR T2 20-75 P TS	56
2CTB803851R2800	OVR T2 20-75 P	56
2CTB803852R1600	OVR T2 2-20-75 P TS	56
2CTB803852R1700	OVR T2 2-20-75 P	56
2CTB803853R4500	OVR T2 3L 40-400/690 P	70
2CTB803853R4600	OVR T2 3L 40-400/690 P TS	70
2CTB803854R0400	OVR T2 40 440 C	36
2CTB803854R1100	OVR T2 40-400/690 C	34
2CTB803871R0500	OVR T2 40-440 P TS QS	65
2CTB803871R1100	OVR T2-T3 20-440 P QS	82
2CTB803871R1200	OVR T2 40-440 P QS	65
2CTB803871R1300	OVR T2-T3 20-440 P TS QS	82
2CTB803871R1700	OVR T2 40-275 P TS QS	61
2CTB803871R2300	OVR T2 40-275 P QS	61
2CTB803871R2400	OVR T2-T3 20-275 P QS	82
2CTB803871R2500	OVR T2-T3 20-275 P TS QS	82
2CTB803873R2400	OVR T2 3L 40-275 P QS	68
2CTB803873R2500	OVR T2 3L 40-275 P TS QS	68
2CTB803873R2700	OVR T2 3L 40-440 P TS QS	70
2CTB803873R2800	OVR T2 3L 40-440 P QS	70
2CTB803873R3400	OVR T2-T3 3L 20-275 P QS	84
2CTB803873R3500	OVR T2-T3 3L 20-275 P TS QS	84
2CTB803873R5100	OVR T2 4L 40-440 P QS	74

Order code	Type	Page
2CTB803873R5200	OVR T2 4L 40-275 P TS QS	74
2CTB803873R5300	OVR T2 4L 40-440 P TS QS	72
2CTB803873R5600	OVR T2 4L 40-275 P QS	72
2CTB803876R0000	OVR T2 N 80-275 C QS	35
2CTB803876R0400	OVR T2 40-440 C QS	34
2CTB803876R0600	OVR T2 20-440 C QS	35
2CTB803876R1000	OVR T2 40-275 C QS	33
2CTB803876R1200	OVR T2 20-275 C QS	35
2CTB803881R0500	OVR T2 40-600 P TS QS	65
2CTB803881R1700	OVR T2 40-350 P TS QS	61
2CTB803881R2300	OVR T2 40-350 P QS	61
2CTB803883R2400	OVR T2 30-350 P QS	68
2CTB803883R2500	OVR T2 3L 40-350 P TS QS	68
2CTB803883R2700	OVR T2 3L 40-600 P TS QS	70
2CTB803883R3000	OVR T2 4L 40-600 P TS QS	74
2CTB803886R0000	OVR T2 N 80-350 C QS	34
2CTB803886R0100	OVR T2 N 80-440 C QS	35
2CTB803886R1000	OVR T2 40-350 C QS	34
2CTB803950R0000	OVR PV 40-600 C	36
2CTB803950R0100	OVR PV 40-1000 C	36
2CTB803950R1000	OVR PV T1 625-600 C	36
2CTB803950R1100	OVR PV T1 625-1000 C	36
2CTB803950R2000	OVR PV 40-1500 C	36
2CTB803951R1300	OVR T2 120-440s P TS	65
2CTB803953R5300	OVR PV 40-600 P	96
2CTB803953R5400	OVR PV 40-600 P TS	96
2CTB803953R5700	OVR PV T1 6.25-600 P TS	96
2CTB803953R6400	OVR PV 40-1000 P	96
2CTB803953R6500	OVR PV 40-1000 P TS	96
2CTB803953R6700	OVR PV T1 6.25-1000 P TS	96
2CTB803972R0500	OVR T2 1N 40-275 P TS QS	76
2CTB803972R1100	OVR T2 1N 40-275 P QS	76
2CTB803972R1200	OVR T2-T3 1N 20-275 P QS	86
2CTB803972R1300	OVR T2-T3 1N 20-275 P TS QS	86
2CTB803973R0500	OVR T2 3N 40-275 P TS QS	79
2CTB803973R1100	OVR T2 3N 40-275 P QS	79
2CTB803973R1200	OVR T2-T3 3N 20-275 P QS	88
2CTB803973R1300	OVR T2-T3 3N 20-440 P QS	88
2CTB803973R1400	OVR T2 3N 40-440 P QS	79
2CTB803973R1500	OVR T2 3N 40-440 P TS QS	79
2CTB803973R1600	OVR T2-T3 3N 20-275 P TS QS	88
2CTB803973R1900	OVR T2 N 80-275 P QS	61
2CTB803973R2000	OVR T2 N 80-440 P QS	65
2CTB803982R0500	OVR T2 1N 40-350 P TS QS	76
2CTB803982R1100	OVR T2 1N 40-350 P QS	76
2CTB803983R0500	OVR T2 3N 40-350 P TS QS	79
2CTB803983R1100	OVR T2 3N 40-350 P QS	79
2CTB803983R1900	OVR T2 N 80-350 P QS	61
2CTB804153R1900	OVR PV 40-1000 P TS BW (x30)	96
2CTB804153R2100	OVR PV 40-1500 P TS BW	96
2CTB804153R2200	OVR PV 40-1500 P BW	96
2CTB804200R0100	OVR T2 20-175	58
2CTB804200R0200	OVR T2 20-175	58
2CTB804200R0700	OVR T2 20-150	58
2CTB804200R1100	OVR T2 20-275 (x20)	58
2CTB804200R1200	OVR T2 20-440 (x20)	65
2CTB804200R1700	OVR T2 20-150 (x20)	58
2CTB804201R0100	OVR T2 40-275	65
2CTB804201R0200	OVR T2 40-440	65
2CTB804201R0700	OVR T2 40-150	58
2CTB804201R1100	OVR T2 40-275 (x20)	58
2CTB804201R1200	OVR T2 40-440 (x20)	65
2CTB804201R1700	OVR T2 40-150 (x20)	58
2CTB804500R0200	OVR T2-T3 N1 15-275s SL	94
2CTB804500Z1200	OVR T2-T3 N1 15-275s SL (x20)	94
2CTB804600R0400	OVR T2 3L 20-275	33
2CTB804600R1400	OVR T2 3L 20-275 (x6)	33
2CTB804600R1500	OVR T2 4L 20-275 (x5)	72
2CTB804601R0400	OVR T2 3L 40-275	68
2CTB804601R0500	OVR T2 4L 40-275	72
2CTB804601R1400	OVR T2 3L 40-275 (x6)	33
2CTB804601R1500	OVR T2 4L 40-275 (x5)	72
2CTB804820R0000	OVR TC 06V P	100
2CTB804820R0100	OVR TC 12V P	100
2CTB804820R0200	OVR TC 24V P	100
2CTB804820R0300	OVR TC 48V P	100
2CTB804820R0400	OVR TC 200V P	100
2CTB804820R0500	OVR TC 200FR P	100
2CTB804821R0000	OVR TC 06V C	36
2CTB804821R0100	OVR TC 12V C	36
2CTB804821R0200	OVR TC 24V C	36
2CTB804821R0300	OVR TC 48V C	36
2CTB804821R0400	OVR TC 200V C	36
2CTB804821R0500	OVR TC 200FR C	36
2CTB804840R1100	BASE OVR TC RJ45	100
2CTB811814R0000	OVR TC 200FR US	132
2CTB811814R0100	OVR TC 06V US	132
2CTB811814R0200	OVR TC 12V US	132
2CTB811814R0300	OVR TC 24V US	132
2CTB811814R0400	OVR TC 48V US	132
2CTB813860R1500	SPD accessories	102
2CTB813912R1000	OVR 1N 10 275	90
2CTB813913R1000	OVR 3N 10 275	90
2CTB814355R2700	SPD accessories	102
2CTB814355R1200	SPD accessories	102
2CTB815101R0100	OVR T1 25-255	38
2CTB815101R0300	OVR T1+2 25-255 TS	48
2CTB815101R0400	OVR T1 50 N	46
2CTB815101R0500	OVR T1 100 N	46
2CTB815101R0600	OVR T1 3L 25-255 TS	40

Order code	Type	Page
2CTB815101R0700	OVR T1 3N 25-255 TS	44
2CTB815101R0800	OVR T1 4L 25-255 TS	44
2CTB815101R1000	OVR T1 1N 25-255 TS	42
2CTB815101R1100	OVR T1 2L 25-255 TS	42
2CTB815101R1200	OVR T1 2L 25-255	42
2CTB815101R1300	OVR T1 3L 25-255	40
2CTB815101R1400	OVR T1 4L 25-255	44
2CTB815101R1500	OVR T1 1N 25-255	42
2CTB815101R1600	OVR T1 3N 25-255	44
2CTB815101R4200	OVR T1+2 4L 25-255 TS	53
2CTB815101R4300	OVR T1+2 3L 25-255 TS	50
2CTB815101R4400	OVR T1+2 1N 25-255 TS	53
2CTB815101R4500	OVR T1+2 3N 25-255 TS	53
2CTB815101R8700	OVR T1 25-255-7	38
2CTB815101R8800	OVR T1 3N 25-255-7	44
2CTB815101R8900	OVR T1+2 15-255-7	48
2CTB815101R9000	OVR T1+2 3N 15-255-7	53
2CTB815101R9300	OVR T1 25-440-50	38
2CTB815101R9700	OVR T1 25 N	46
2CTB815102R0400	SPD accessories	102
2CTB815141R0700	SPD accessories	102
2CTB815704R0000	OVR T2 40-275s P TS QS	61
2CTB815704R0200	OVR T2 1N 40-275s P TS QS	76
2CTB815704R0600	OVR T2 3L 40-275s P TS QS	68
2CTB815704R0800	OVR T2 3N 40-275s P TS QS	79
2CTB815704R1100	OVR T2 4L 40-275s P TS QS	72
2CTB815704R1200	OVR T2 40-275s P QS	61
2CTB815704R1400	OVR T2 1N 40-275s P QS	76
2CTB815704R1800	OVR T2 3L 40-275s P QS	68
2CTB815704R2000	OVR T2 3N 40-275s P QS	79
2CTB815704R2300	OVR T2 4L 40-275s P QS	72
2CTB815704R2600	OVR T2 40-275s C QS	33
2CTB815704R2900	OVR T2 40-440s P TS QS	65
2CTB815704R3700	OVR T2 3N 40-440s P TS QS	65
2CTB815704R4100	OVR T2 4L 40-440s P TS QS	79
2CTB815704R4100	OVR T2 40-440s C QS	34
2CTB815708R0000	OVR T2 80-275s P TS QS	61
2CTB815708R0200	OVR T2 1N 80-275s P TS QS	76
2CTB815708R0600	OVR T2 3L 80-275s P TS QS	68
2CTB815708R0800	OVR T2 3N 80-275s P TS QS	79
2CTB815708R1100	OVR T2 4L 80-275s P TS QS	72
2CTB815708R1200	OVR T2 80-275s P QS	61
2CTB815708R1400	OVR T2 1N 80-275s P QS	76
2CTB815708R1800	OVR T2 3L 80-275s P QS	68

Index

Type classification

Type	Order code	Page
BASE OVR TC RJ45	2CTB804840R1100	100
OVR 1N 10 275	2CTB813912R1000	90
OVR 3N 10 275	2CTB813913R1000	90
OVR PLUS N1 20	2CTB803701R0700	92
OVR PLUS N1 40	2CTB803701R0100	92
OVR PLUS N3 20	2CTB803701R0400	92
OVR PLUS N3 40	2CTB803701R0300	92
OVR PV 15-1000 C U	2CTB802349R4100	110
OVR PV 15-1000 P TS U	2CTB802340R8100	129
OVR PV 15-1000 P U	2CTB802340R8000	129
OVR PV 15-600 C U	2CTB802349R2900	110
OVR PV 15-600 P TS U	2CTB802340R5700	129
OVR PV 15-600 P U	2CTB802340R5600	129
OVR PV 15-800 C U	2CTB802349R3500	110
OVR PV 15-800 P TS U	2CTB802340R6900	129
OVR PV 15-800 P U	2CTB802340R6800	129
OVR PV 40-1000 C	2CTB803950R0100	36
OVR PV 40-1000 C U	2CTB802349R1600	110
OVR PV 40-1000 P	2CTB803953R6400	96
OVR PV 40-1000 P TS	2CTB803953R6500	96
OVR PV 40-1000 P TS BW (x30)	2CTB804153R1900	96
OVR PV 40-1000 P TS U	2CTB802340R3300	129
OVR PV 40-1000 P U	2CTB802340R3200	129
OVR PV 40-1500 C	2CTB803950R2000	36
OVR PV 40-1500 P BW	2CTB804153R2200	96
OVR PV 40-1500 P TS BW	2CTB804153R2100	96
OVR PV 40-1500H C U	2CTB802349R1700	110
OVR PV 40-1500H P TS U	2CTB802340R4300	129
OVR PV 40-1500H P U	2CTB802340R4200	129
OVR PV 40-600 C	2CTB803950R0000	36
OVR PV 40-600 C U	2CTB802349R0300	110
OVR PV 40-600 P	2CTB803953R5300	96
OVR PV 40-600 P TS	2CTB803953R5400	96
OVR PV 40-600 P TS U	2CTB802340R0900	129
OVR PV 40-600 P U	2CTB802340R0800	129
OVR PV 40-800 C U	2CTB802349R1000	110
OVR PV 40-800 P TS U	2CTB802340R2100	129
OVR PV 40-800 P U	2CTB802340R2000	129
OVR PV T1 6.25-1000 P TS	2CTB803953R6700	96
OVR PV T1 6.25-600 P TS	2CTB803953R5700	96
OVR PV T1 6.25-1000 C	2CTB803950R1100	36
OVR PV T1 6.25-600 C	2CTB803950R1000	36
OVR T1 100 N	2CTB815101R0500	46
OVR T1 1N 25-255	2CTB815101R1500	42
OVR T1 1N 25-255 TS	2CTB815101R1000	42
OVR T1 25 N	2CTB815101R09700	46
OVR T1 25-255	2CTB815101R0100	38
OVR T1 25-255-7	2CTB815101R8700	38
OVR T1 25-440-50	2CTB815101R9300	38
OVR T1 2L 25-255	2CTB815101R1200	42
OVR T1 2L 25-255 TS	2CTB815101R1100	42
OVR T1 3L 25-255	2CTB815101R1300	40
OVR T1 3L 25-255 TS	2CTB815101R0600	40
OVR T1 3N 25-255	2CTB815101R1600	44
OVR T1 3N 25-255 TS	2CTB815101R0700	44
OVR T1 3N 25-255-7	2CTB815101R8800	44
OVR T1 4L 25-255	2CTB815101R1400	44
OVR T1 4L 25-255 TS	2CTB815101R0800	44
OVR T1 50 N	2CTB815101R0400	46
OVR T1+2 15-255-7	2CTB815101R8900	48
OVR T1+2 1N 25-255 TS	2CTB815101R4400	53
OVR T1+2 25-255 TS	2CTB815101R0300	48
OVR T1+2 3L 25-255 TS	2CTB815101R4300	50
OVR T1+2 3N 15-255-7	2CTB815101R9000	53
OVR T1+2 3N 25-255 TS	2CTB815101R4500	53
OVR T1+2 4L 25-255 TS	2CTB815101R4200	53
OVR T1-2 12.5-275s C QS	2CTB81510R2600	32
OVR T1-2 12.5-275s P QS	2CTB81510R1200	48
OVR T1-2 12.5-275s P TS QS	2CTB81510R0000	48
OVR T1-2 12.5-440s C QS	2CTB81510R5500	32
OVR T1-2 12.5-440s P QS	2CTB81510R4100	48
OVR T1-2 12.5-440s P TS QS	2CTB81510R2900	48
OVR T1-2 1N 12.5-275s P QS	2CTB81510R1300	53
OVR T1-2 1N 12.5-275s P TS QS	2CTB81510R0100	53
OVR T1-2 1N 12.5-440s P QS	2CTB81510R4200	53
OVR T1-2 1N 12.5-440s P TS QS	2CTB81510R3000	53
OVR T1-2 3L 12.5-275s P QS	2CTB81510R1800	50
OVR T1-2 3L 12.5-275s P TS QS	2CTB81510R0600	50
OVR T1-2 3L 12.5-440s P QS	2CTB81510R4700	50
OVR T1-2 3L 12.5-440s P TS QS	2CTB81510R3500	50
OVR T1-2 3N 12.5-275s P QS	2CTB81510R1900	53
OVR T1-2 3N 12.5-275s P TS QS	2CTB81510R0700	53
OVR T1-2 3N 12.5-440s P QS	2CTB81510R4800	53
OVR T1-2 3N 12.5-440s P TS QS	2CTB81510R3600	53
OVR T1-2 4L 12.5-275s P QS	2CTB81510R2300	53
OVR T1-2 4L 12.5-275s P TS QS	2CTB81510R1100	53
OVR T1-2 4L 12.5-440s P QS	2CTB81510R5200	53
OVR T1-2 4L 12.5-440s P TS QS	2CTB81510R4000	53
OVR T1-2 N 50-275s C QS	2CTB8150R2700	32
OVR T1-2 N 50-275s P QS	2CTB81510R2400	48
OVR T1-2 N 50-440s P QS	2CTB81510R5300	48
OVR T2 120-440s P TS	2CTB803951R1300	65
OVR T2 15-150 C U	2CTB802348R2500	109
OVR T2 15-150 P U	2CTB802341R0000	111
OVR T2 15-320 C U	2CTB802348R2700	109
OVR T2 15-320 P U	2CTB802341R0400	111
OVR T2 1N 15-150 P U	2CTB802342R0000	117
OVR T2 1N 15-320 P U	2CTB802342R0400	117
OVR T2 1N 40-150 P TS U	2CTB802342R2100	117
OVR T2 1N 40-150 P U	2CTB802342R2000	117

Type	Order code	Page
OVR T2 1N 40-150 P U (x10)	2CTB802342R8000	117
OVR T2 1N 40-275 P QS	2CTB803972R1100	76
OVR T2 1N 40-275 P TS QS	2CTB803972R0500	76
OVR T2 1N 40-275s P QS	2CTB815704R1400	76
OVR T2 1N 40-275s P TS QS	2CTB815704R0200	76
OVR T2 1N 40-320 P TS U	2CTB802342R2500	117
OVR T2 1N 40-350 P QS	2CTB803982R1100	76
OVR T2 1N 40-350 P TS QS	2CTB803982R0500	76
OVR T2 1N 40-440 P TS U	2CTB802342R2900	117
OVR T2 1N 40-550 P TS U	2CTB802342R3300	117
OVR T2 1N 40-660 P TS U	2CTB802342R3700	117
OVR T2 1N 80-275s P QS	2CTB815708R1400	76
OVR T2 1N 80-275s P TS QS	2CTB815708R0200	76
OVR T2 2 20-75 P	2CTB803852R1700	56
OVR T2 2 20-75 P TS	2CTB803852R1600	56
OVR T2 20-150	2CTB804200R0700	58
OVR T2 20-150 (x20)	2CTB804200R1700	58
OVR T2 20-275	2CTB804200R0100	58
OVR T2 20-275 (x20)	2CTB804200R1100	58
OVR T2 20-275 C QS	2CTB803876R1200	35
OVR T2 20-440	2CTB804200R0200	65
OVR T2 20-440 (x20)	2CTB804200R1200	65
OVR T2 20-440 C QS	2CTB803876R0600	35
OVR T2 20-75 P	2CTB803851R2900	56
OVR T2 20-75 P TS	2CTB803851R2700	56
OVR T2 2L 15-150 P U	2CTB802343R0000	121
OVR T2 2L 15-320 P U	2CTB802343R0400	121
OVR T2 2L 15-150 P TS U	2CTB802343R2100	121
OVR T2 2L 40-320 P TS U	2CTB802343R2500	121
OVR T2 2N 15-150 P U	2CTB802344R0000	121
OVR T2 2N 15-320 P U	2CTB802344R0400	121
OVR T2 2N 40-150 P TS U	2CTB802344R2100	121
OVR T2 2N 40-320 P TS U	2CTB802344R2500	121
OVR T2 2N 40-440 P TS U	2CTB802344R2900	121
OVR T2 2N 40-550 P TS U	2CTB802344R3300	121
OVR T2 2N 40-660 P TS U	2CTB802344R3700	121
OVR T2 3L 15-150 P U	2CTB802345R0000	125
OVR T2 3L 15-320 P U	2CTB802345R0400	114
OVR T2 3L 20-275	2CTB804600R0400	68
OVR T2 3L 20-275 (x6)	2CTB804600R1400	33
OVR T2 3L 40-150 P TS U	2CTB802345R2100	125
OVR T2 3L 40-275	2CTB804601R0400	68
OVR T2 3L 40-275 (x6)	2CTB804601R1400	33
OVR T2 3L 40-275 P QS	2CTB803873R2400	68
OVR T2 3L 40-275 P TS QS	2CTB803873R2500	68
OVR T2 3L 40-275s P QS	2CTB815704R1800	68
OVR T2 3L 40-275s P TS QS	2CTB815704R0600	68
OVR T2 3L 40-320 P TS U	2CTB802345R2500	114
OVR T2 3L 40-350 P QS	2CTB803883R2900	68
OVR T2 3L 40-350 P TS QS	2CTB803883R2500	68
OVR T2 3L 40-400/690 P	2CTB803853R4500	70
OVR T2 3L 40-400/690 P TS	2CTB803853R4600	70
OVR T2 3L 40-440 P QS	2CTB803873R2800	70
OVR T2 3L 40-440 P TS QS	2CTB803873R2700	70
OVR T2 3L 40-440 P TS U	2CTB802345R2900	125
OVR T2 3L 40-550 P TS U	2CTB802345R3300	114
OVR T2 3L 40-600 P TS QS	2CTB803883R2700	70
OVR T2 3L 80-275s P QS	2CTB815708R1800	68
OVR T2 3L 80-275s P TS QS	2CTB815708R0600	68
OVR T2 3L 80-440s P QS	2CTB815708R4700	70
OVR T2 3L 80-440s P TS QS	2CTB815708R3500	70
OVR T2 3N 15-150 P U	2CTB802346R0000	125
OVR T2 3N 15-320 P U	2CTB802346R0400	125
OVR T2 3N 40-150 P TS U	2CTB802346R2100	125
OVR T2 3N 40-275 P QS	2CTB803973R1100	79
OVR T2 3N 40-275 P TS QS	2CTB803973R0500	79
OVR T2 3N 40-275s P QS	2CTB815704R2000	79
OVR T2 3N 40-275s P TS QS	2CTB815704R0800	79
OVR T2 3N 40-320 P TS U	2CTB802346R2500	125
OVR T2 3N 40-350 P QS	2CTB803983R1100	79
OVR T2 3N 40-350 P TS QS	2CTB803983R0500	79
OVR T2 3N 40-440 P QS	2CTB803973R1400	79
OVR T2 3N 40-440 P TS QS	2CTB803973R1500	79
OVR T2 3N 40-440 P TS U	2CTB802346R2900	125
OVR T2 3N 40-440s P TS QS	2CTB815704R3700	79
OVR T2 3N 40-550 P TS U	2CTB802346R3300	125
OVR T2 3N 40-660 P TS U	2CTB802346R3700	125
OVR T2 3N 80-275s P QS	2CTB815708R2000	79
OVR T2 3N 80-275s P TS QS	2CTB815708R0800	79
OVR T2 3N 80-440s P QS	2CTB815708R4900	79
OVR T2 3N 80-440s P TS QS	2CTB815708R3700	79
OVR T2 40-150	2CTB804201R0700	58
OVR T2 40-150 (x20)	2CTB804201R1700	58
OVR T2 40-150 C U	2CTB802348R3500	109
OVR T2 40-150 P TS U	2CTB802341R2100	111
OVR T2 40-150 P U	2CTB802341R2000	111
OVR T2 40-275	2CTB804201R0100	58
OVR T2 40-275 (x20)	2CTB804201R1100	58
OVR T2 40-275 C QS	2CTB803876R1000	33
OVR T2 40-275 P QS	2CTB803871R2300	61
OVR T2 40-275 P TS QS	2CTB803871R1700	61
OVR T2 40-275s C QS	2CTB815704R2600	33
OVR T2 40-275s P QS	2CTB815704R1200	61
OVR T2 40-275s P TS QS	2CTB815704R0000	61
OVR T2 40-320 C U	2CTB802348R3700	109
OVR T2 40-320 P TS U	2CTB802341R2500	111
OVR T2 40-320 P U	2CTB802341R2400	111
OVR T2 40-350 C QS	2CTB803886R1000	34
OVR T2 40-350 P QS	2CTB803881R2300	61

Type	Order code	Page
OVR T2 40-350 P TS QS	2CTB803881R1700	61
OVR T2 40-400/690 C	2CTB803854R1100	34
OVR T2 40-440	2CTB804201R0200	65
OVR T2 40-440 (x20)	2CTB804201R1200	65
OVR T2 40-440 C QS	2CTB803876R0400	34
OVR T2 40-440 C U	2CTB802348R3900	109
OVR T2 40-440 P QS	2CTB803871R1200	65
OVR T2 40-440 P TS QS	2CTB803871R0500	65
OVR T2 40-440s C QS	2CTB815704R5500	34
OVR T2 40-440s P QS	2CTB815704R4100	65
OVR T2 40-440s P TS QS	2CTB815704R2900	65
OVR T2 40-550 C U	2CTB802348R4100	109
OVR T2 40-550 P TS U	2CTB802341R3300	111
OVR T2 40-600 P TS QS	2CTB803881R0500	65
OVR T2 40-660 C U	2CTB802348R4300	109
OVR T2 40-660 P TS U	2CTB802341R3700	111
OVR T2 4L 20-275 (x5)	2CTB804600R1500	72
OVR T2 4L 40-275	2CTB804601R0500	72
OVR T2 4L 40-275 (x5)	2CTB804601R1500	72
OVR T2 4L 40-275 P QS	2CTB803873R5600	72
OVR T2 4L 40-275 P TS QS	2CTB803873R5200	72
OVR T2 4L 40-275s P QS	2CTB815704R2300	72
OVR T2 4L 40-275s P TS QS	2CTB815704R1100	72
OVR T2 4L 40-440 P QS	2CTB803873R5100	74
OVR T2 4L 40-440 P TS QS	2CTB803873R5300	74
OVR T2 4L 40-600 P TS QS	2CTB803883R5300	74
OVR T2 4L 80-275s P QS	2CTB815708R2300	72
OVR T2 4L 80-275s P TS QS	2CTB815708R1500	72
OVR T2 4L 80-440s P QS	2CTB815708R5200	74
OVR T2 4L 80-440s P TS QS	2CTB815708R4000	74
OVR T2 70 N C U	2CTB802348R6500	108
OVR T2 70 N P U	2CTB802341R8000	111
OVR T2 80-275s C QS	2CTB815708R2600	33
OVR T2 80-275s P QS	2CTB804601R3300	61
OVR T2 80-275s P TS QS	2CTB815708R0000	61
OVR T2 80-440s C QS	2CTB815708R5500	34
OVR T2 80-440s P QS	2CTB815708R4100	65
OVR T2 80-440s P TS QS	2CTB815708R2900	65
OVR T2 N 80-275 C QS	2CTB803973R2000	65
OVR T2 N 80-275 P QS	2CTB803973R1900	61
OVR T2 N 80-275s C QS	2CTB815708R2800	33
OVR T2 N 80-275s P QS	2CTB815708R2500	61
OVR T2 N 80-350 C QS	2CTB803886R0000	34
OVR T2 N 80-350 P QS	2CTB803873R1900	61
OVR T2 N 80-440 C QS	2CTB803886R0100	35
OVR T2 N 80-440 P QS	2CTB803973R2000	

Marketing tools

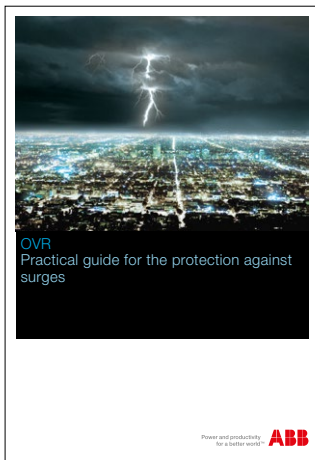

Brochure
OVR Practical guide
for the protection against surges
1TXH000309C0201



Brochure
Autoprotected surge arresters
New OVR PLUS range
1TXH000045B0203



Brochure
Lightning and overvoltage protection
for lighting systems
1TXH000312B0202

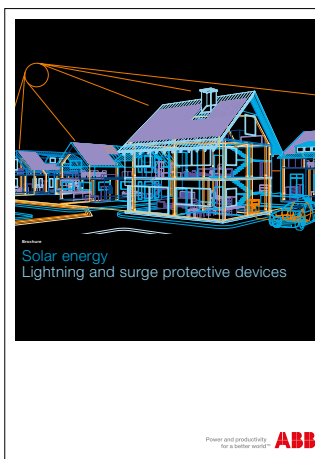

Brochure
Solar energy
Lightning and surge protective devices
1TXH000118B0202

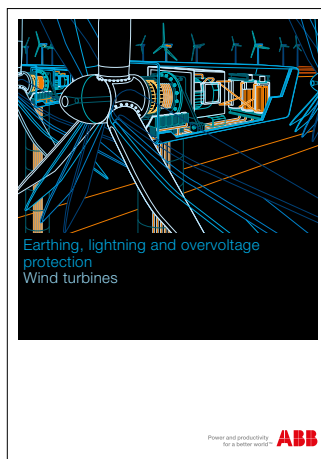

Brochure
Earthing, lightning and overvoltage protection
Wind turbines
1TXH000215B0201

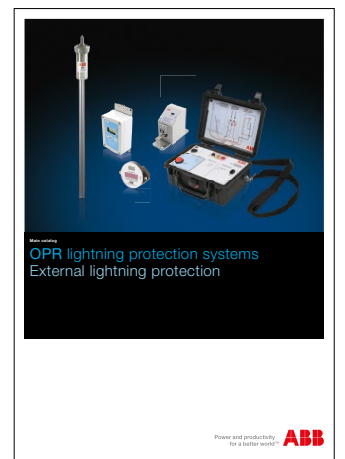

Main catalog
OPR lightning protection systems
External lightning protection
1TXH000247C0202

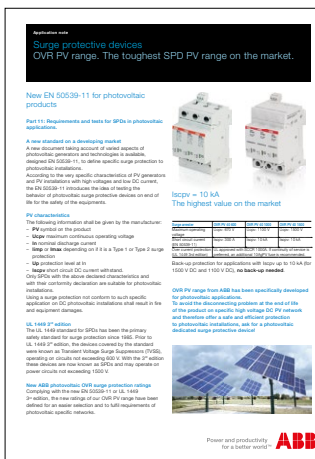

Application note
Surge protective devices - OVR PV range.
The toughest SPD PV range on the market.
1TXH000313L0202

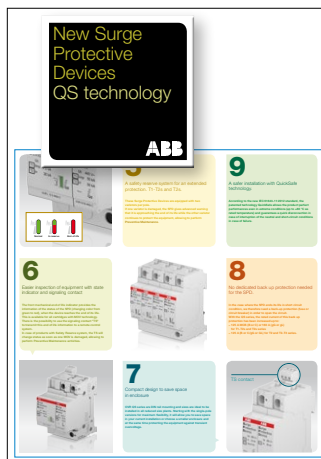

Leaflet
New Surge Protective Devices
QS technology
1TXH000351E0201

Contact us

ABB France

Low Voltage Products Division

Pôle Foudre Soulé & Hérita

1, avenue des Victimes du 11 juin 1944

BP 303

F-65203 Bagnères-de-Bigorre / France

Tél. : +33 (0)5 62 91 45 60

Fax : +33 (0)5 62 91 45 62

Email : stv.lpg@fr.abb.com



www.abb.com/windpower



www.furse.com



<http://www.abb.com/lowvoltage>



www.abb.com

Note

We reserve the right to make technical changes or modify the contents of this document without prior notice.

ABB does not accept any responsibility whatsoever for potential errors or possible lack of information in this document.

We reserve all rights in this document and in the subject matter and illustrations contained therein. Any reproduction, disclosure to third parties or utilization of its contents – in whole or in parts – is forbidden without prior written consent of ABB.

Copyright© 2015 ABB - All rights reserved